

AZOLLA UTILIZATION

Proceedings of the Workshop
on Azolla Use

Fuzhou, Fujian, China
31 March-5 April 1985

Sponsored by:
The Fujian Academy of Agricultural Sciences
Fuzhou, Fujian, China
and
The International Rice Research Institute
Los Baños, Laguna, Philippines

1987

International Rice Research Institute
P.O. Box 933, Manila, Philippines

The International Rice Research Institute (IRRI) was established in 1960 by the Ford and Rockefeller Foundations with the help and approval of the Government of the Philippines. Today IRRI is one of the 13 nonprofit international research and training centers supported by the Consultative Group on International Agricultural Research (CGIAR). The CGIAR is sponsored by the Food and Agriculture Organization (FAO) of the United Nations, the International Bank for Reconstruction and Development (World Bank), and the United Nations Development Programme (UNDP). The CGIAR consists of 50 donor countries, international and regional organizations, and private foundations.

IRRI receives support, through the CGIAR, from a number of donors including: the Asian Development Bank, the European Economic Community, the Ford Foundation, the International Development Research Centre, the International Fund for Agricultural Development, the OPEC Special Fund, the Rockefeller Foundation, the United Nations Development Programme, the World Bank, and the international aid agencies of the following governments: Australia, Belgium, Canada, China, Denmark, France, Federal Republic of Germany, India, Italy, Japan, Mexico, Netherlands, New Zealand, Norway, Philippines, Saudi Arabia, Spain, Sweden, Switzerland, United Kingdom, and United States.

The responsibility for this publication rests with the International Rice Research Institute.

Copyright © International Rice Research Institute 1987

All rights reserved. Except for quotations of short passages for the purpose of criticism and review, no part of this publication may be reproduced, stored in retrieval systems, or transmitted in any form or by any means, electronic, mechanical, photocopying, recording, or otherwise, without prior permission of IRRI. This permission will not be unreasonably withheld for use for noncommercial purposes. IRRI does not require payment for the noncommercial use of its published works, and hopes that this copyright declaration will not diminish the bona fide use of its research findings in agricultural research and development.

The designations employed and the presentation of the material in this publication do not imply the expression of any opinion whatsoever on the part of IRRI concerning the legal status of any country, territory, city, or area, or of its authorities, or concerning the delimitation of its frontiers or boundaries.

Contents

Foreword

Opening remarks

Recommendations 1

TAXONOMY, MORPHOLOGY, AND PHYSIOLOGY OF *AZOLLA-ANABAENA* SYMBIOSIS

Taxonomy and species recognition in *Azolla* Lam. 7

D.G. Dunham and K. Fowler

Comparative study of the morphology, anatomy, and phylogenesis of megasporocarps in sections *Euzolla* and *Rhizosperma* 17

He Guo-fan and Lin Yue-chan

Methods for using *Azolla filiculoides* sporocarps to culture sporophytes in the field 27

Lu Shuying

Germination of *Azolla filiculoides* Lam. sporocarps and factors affecting their growth 33

Xiao Qing-yuan, Shi Yan-ru, Yang Guang-li, and Peng Ke-lin

Morphogenesis of sporocarps of *Azolla microphylla* 39

E.G. Cutter and Y.R. Herd

Biochemical basis of *Azolla-Anabaena azollae* symbiosis 47

J.K. Ladha and I. Watanabe

Some physiological properties of akinetes of *Anabaena azollae* 59

Bai Ke-zhi, Wu Guoliang, and Cheng Cui

USE OF *AZOLLA* FOR MULTIPLE PURPOSES

Reevaluation of *Azolla* utilization in agricultural production 67

Liu Chung-chu

Azolla collection and selection 77

C. Van Hove, T. de Waha Baillonville, H.F. Diara, P. Godard, Y. Mai Kodomi, and N. Sanginga

Environmental requirements for successful *Azolla* growth 89

T.A. Lumpkin

USE OF *AZOLLA* IN VARIOUS REGIONS

The *Azolla* program of the Philippines 101

B.B. Mabbayad

Use of *Azolla* in India 109

S. Kannaiyan

Azolla use in Thailand **119**

L. Loudhapasitiporn and C. Kanareugsa

Use of *Azolla* in Brazil **123**

M.F. Fiore and K.G. Gutbrod

Use of *Azolla* in Sri Lanka **131**

S.A. Kulasoorya, W.K. Hirimburegama, and S.W. Abeysekera

Utilization of *Azolla* in agricultural production in Guangdong Province, China **141**

Zhang Zhuang-ta, Ke Yu-si, Ling De-quan, Duan Bing-Yuan, and Liu Xi-lian
Azolla and its use in rice culture in West Africa **147**

H.F. Diara, H. Van Brandt, A.M. Diop, and C. Van Hove

Use and importance of *Azolla-Anabaena* in industrial countries **153**

H.W. Scharpenseel and K. Knuth

Use of *Azolla* as a decontaminant in sewage treatment **169**

N. Shiomi and S. Kitoh

Use of *Azolla* in Pakistan **177**

S. Ali and K.A. Malik

AGRONOMICAL ASPECT OF *AZOLLA* USE

Some aspects of rice-*Azolla* association in northern China **189**

You Chongbiao, Zhang Rongju, and Song Wei

Summary report of the *Azolla* program of the International Network on Soil Fertility and Fertilizer Evaluation for Rice **197**

I. Watanabe

Insect pests of *Azolla* in the Philippines **207**

O. Mochida, Y. Yoshiyasu, and D. Dimaano

Determination of amount of N_2 fixation and change in N_2 -fixing activity of *Azolla* in natural environment **223**

Li Zhuo-xin, Zu Shou-xian, Mao Mei-fei, Wang Fu-lai, and Zhao Bing-bo

Use of ^{15}N in N_2 -fixation and N cycling studies of *Azolla* **233**

D.L. Eskew

Decomposition of *Azolla* in the field and availability of *Azolla* nitrogen to plants **241**

Wen Qi-xiao, Cheng Li-li, and Shi Shu-lian

Studies on the promotion of nitrogen fixation and hydrogen evolution in *Azolla imbricata* by cast iron **255**

Liang Zhong-jin, Cheng Shuang-gi, and Mo Hsi-mu

POSTER ABSTRACTS

Azolla in the Philippines **265**

J.C. Bunoan, Jr. and C. Bersabe

Kiwanis *Azolla* program in the Philippines **266**

A.C. Leviste

Experiment report of discovery and use of Fangshan County wild *Azolla* **267**

Wang Zai de and Wang Pu

The economic value and use of red duckweed *Azolla* sp. in Anhui Province, China **268**

Xi Qie-ming

- Cichlasoma* and *Tilapia* selective appetency for *Azolla* **269**
 T. Antoine, S. Carraro, J.C. Micha, and C. Van Hove
- Study of *Azolla* as a fish fodder **270**
 Chen De-fu and Huang Chun-yuan
- The rotation of rice and *Azolla* for rational use of perennially submerged land **270**
 Zhang Chunlun
- Study of utilization of *Azolla* in paddy fields in Beijing **271**
 Wang Pu and Wang Zai de
- Effect of soil conditions on the decomposition rate of *Azolla* **273**
 Lin Xinxiong and Wen Qixiao
- The cultivation of *Azolla filiculoides* for the reclamation and utilization of heavy saline soil **274**
 Shang Deng-hui, Wu ho, Chen Xi-pan, and Gu Rong-sain
- Studies on *Azolla* mineralization rate and nutrient releasing dynamics **275**
 Wang De-xian, Zhao Miao-zheng, and Chen De-fu
- Estimation and utilization of the constant of the effectively accumulated temperature of *Pyralis* sp. and *Nymphulaenixalis* **276**
 Zhu Zhonglin and Jian Soufa
- Estimation of N₂ fixation and excretion of *Azolla* by the ¹⁵N dilution technique **278**
 Chen Binghaun, Zhang Weiguang, Tang Jiangyang, and Li Chungzhu
- Response of *Azolla* to phosphorus, potassium, and zinc in different paddy soils **279**
 Sikander Ali and I. Watanabe
- Micronutrients and the activity of nitrogenase in *Azolla* **280**
 Wei You-zhong, Yang Yu-ai, and Sun Xi
- Diurnal and seasonal variation in the nitrogenase activity of *Azolla* **281**
 Zheng Wei-wen and Lu Pei-ji
- Influence of nitrogen nutrition on the physiological properties of *Azolla*: effect of urea **282**
 Ren Yun, You Chongbiao, and Wei Wen-xiong
- The tolerance and concentration capacity of *Azolla* to 11 metal ions **282**
 Wen Yong-huang and Xiang Wei-zhen
- Study on the multiranked technique of *Azolla* culture **283**
 Wen Yong-huang and Xiang Wei-zhen
- Tolerance of *Azolla caroliniana* and its application **283**
 Wei Wen-xiong, Ye Guo-tian, Zheng Guo-zhang, Cheng Feng-yue, Jin Gui-ying, Liu Pei-ji, and Zheng Wei-wen
- Effect of the biopesticide B.T.I. on the control of chironomids (*Polypediumiuinoense* Hauber) **284**
 Lu Pei-ji and Lin Chang
- Study of the biological properties and control of *Azolla* midge **285**
 Chen Jia Ju
- Effect of insecticides on the growth and nitrogen fixation in *Azolla* **286**
 S. Kannaiyan and K. Nandabalan
- Influence of neem cake on black rot disease incidence in *Azolla* **287**
 S. Kannaiyan and K. Nandabalan

The development of microsporangia and microspores in *Azolla filiculoides* **288**
HeGuo-fan and Lin Yue-chan

The fluorescent antibody staining reaction of *Anabaena azollae* and its cultures
in vitro **289**

Wei Wen-xiong, Jin Gui-ying, Zheng Wei-wen, and Liu Chung-chu
A fluorescent antibody assay for detecting antibodies to surface antigen on
Anabaena azollae: a preliminary report **290**

Tang Long-fei, Zhen Qi, Zhen De-ying, Liu Chung-chu, Cheng You-chuang, and
Lin Tian-long

Preliminary studies on isolation and fusion of *Azolla* protoplasts **291**
Chen Wan-hua, Xie Ying-xian, and Chen Ting-wei

Participants 293

Foreword

The first internationally organized Workshop on *Azolla* Use was held 31 March to 5 April 1985 at the Fujian Academy of Agricultural Sciences (FAAS). The workshop was held at the invitation of FAAS to coincide with the inauguration of the FAAS National *Azolla* Research Center.

Thirty-two participants from 10 countries joined with 44 eminent Chinese scientists to discuss uses of *Azolla* as a biofertilizer and as a feed for animals and fish, methods of determining its nitrogen-fixing ability, and *Azolla* taxonomy.

Although farmers in Fujian Province, China, have for hundreds of years routinely grown *Azolla* as a green manure for their crops, it is only recently that countries other than China and Vietnam have begun to take advantage of *Azolla* as a biofertilizer. Liu Chung-chu, vice president of FAAS, underscored this fact when, during his opening day address, he called for a new recognition and evaluation of the role of *Azolla*. It is hoped that the proceedings of the workshop will provide a focus for further research on *Azolla*, and contribute to its wider use in China and in many developing countries.

I am grateful to the FAAS for cosponsoring the workshop with the International Rice Research Institute (IRRI), and to Liu Chung-chu of FAAS and Iwao Watanabe of IRRI, cochairmen of the organizing committee. This volume was edited by W. H. Smith with the assistance of Emerita P. Cervantes.

M. S. SWAMINATHAN
Director General

Opening remarks

Mr. Chairman, honored delegates, ladies and gentlemen. I would like to thank the Fujian Academy of Agricultural Sciences for inviting FAO's participation at this international Workshop on *Azolla* Use, which also marks the establishment of China's National *Azolla* Research Center.

The founding of the center is timely, not only for China's continued development in agricultural sciences, but also for prospective technical cooperation in the field of *Azolla* between developing countries within the Asia and Pacific Region and beyond. In this respect it may be noted that one of the recommendations of the 17th FAO Regional Conference for Asia and the Pacific, held in Islamabad, Pakistan, last year was a call for increased development and application of biofertilizers in general and *Azolla* in particular as an alternative to, or in combination with, chemical fertilizers.

Also last year, an activity of our Regional Organic Recycling Network was to undertake a status report on *Azolla*. Problems encountered were summarized under five headings: organization, cultural management, utilization, promotion, and research and development of *Azolla* in the region. It is beyond the scope of this brief speech to cover all these headings, but I would like to quote the summary of organizational problems.

Difficulties mentioned included the indifferent attitude toward organic fertilization, the lack of policy and financial support for organic fertilization programs, poor coordination among relevant institutions, the lack of recognition of lead agencies promoting organic fertilization in general and *Azolla* in particular, and a lack of organized and trained personnel at the extension level.

The very fact that we are here today to witness the establishment of China's National *Azolla* Research Center for research and development indicates that at least one country has recognized these difficulties and has taken firm steps to advance *Azolla* utilization.

On behalf of FAO, I wish the National *Azolla* Research Center at the Fujian Academy of Agricultural Sciences continued success in its activities and look forward to fruitful collaboration in the future.

F. J. DENT
Regional Soil Management and
Fertilizer Use Officer
FAO Regional Officer for Asia
and the Pacific

Recommendations

Group I

Applied use of *Azolla* as a green manure

The following were identified as approaches to overcoming constraints to the use of *Azolla* as a green manure.

Basic

1. Develop artificial methods to induce sporocarp formation and production of a high megasporocarp-to-microsporocarp ratio. The use of sporocarps as seeding material can reduce labor and input requirements by avoiding the need for maintenance nurseries and a certain portion of multiplication nurseries.
2. Conduct a comparative analysis of decomposition and N release by different strains of *Azolla* at different growth stages to improve N availability to rice plants.
3. Select strains with a low P requirement, a high N-P ratio, and high growth rate to reduce the need for P fertilization.
4. Screen strains for tolerance for salinity and acid sulfate soils.
5. Test the use of the combination of insecticide and fungicide to determine the interaction of fungi damage with insect attack and continue screening for resistance to pests.

Applied

1. Develop methods for improved P uptake efficiency and use, such as P loading nurseries or foliar application.
2. Investigate integrated management systems, including alternate uses of *Azolla* and the selection of rice varieties that complement *Azolla* use in the cropping system.
3. Develop recommendations for the complementary use of *Azolla* and chemical sources of nitrogen and elucidate their interactions, including long-term trials.
4. Continue research on *Azolla's* contribution to weed control and herbicide interactions with *Azolla*.
5. Determine if *Azolla* can be a useful source of K in K-deficient soils.
6. Develop moist soil culture of *Azolla* under hot conditions.
7. Modify existing implements and develop new implements to incorporate *Azolla* and reduce labor requirements.

Group II

Use of Azolla for animal and fish feed and other purposes

Detailed discussions on the chemical composition of *Azolla* and its nutritive value for pigs, chickens, ducks, fish, and ruminants (cattle, goat, and sheep) were held. In most areas it was agreed that at best, only empirical information existed and further research to define the potential of *Azolla* as a source of feed for animals was urgently needed.

Major research priorities

1. Definition of the chemical composition of *Azolla* species and strains at different stages of growth and under different environmental conditions. This information is needed to predict the potential value of *Azolla* as a source of nutrients for animals.
2. Determination of the nutritive value of *Azolla* for pigs, poultry, fish, and ruminants, with particular emphasis on the following areas:
 - a. the relative merits of different species and strains,
 - b. the optimum proportion of *Azolla* for use in rations, and
 - c. the comparative value of fresh, dried, and ensiled *Azolla* as sources of feed.
3. Determination of the management practices required to maximize productivity of *Azolla* as a source of feed.
4. The use of *Azolla* in the control of water pollution.
5. The establishment of a communication network between scientists working on the nutritive value of *Azolla* to facilitate the free exchange of publications and information.

Discussion points

1. Chemical composition

Information here will provide predictive value of *Azolla* as animal feed. There is a need to measure dry matter content, nitrogen (protein and nonprotein and amino acids), lipids (amount and composition), cell wall content (neutral detergent fiber, acid detergent fiber, and lignin), and macro- and microelement content. In all cases, a clear definition must be given of the species, strain, stage of growth, and environmental conditions under which this material has been grown.

2. Nutritional value

For both pigs and poultry, there is lack of specific information on the levels to which *Azolla* can be incorporated in rations. This information is needed before any practical recommendations on nutritive value can be made. Because *Azolla* is a heavy metal accumulator, toxicity to animals may be a

problem. Alternatively *Azolla* may be an important source of essential trace minerals for pig and poultry rations, when incorporated at appropriate levels.

3. Storage techniques

Azolla is most commonly fed in the fresh form harvested daily. It was proposed that if suitable storage techniques such as sun-drying or ensilaging were available, the problems of maintaining supply when growth rates are low could be overcome. Dried *Azolla* has been found less palatable than fresh *Azolla*, and different strains of fresh *Azolla* vary in palatability. *Azolla* has been successfully ensiled with salt in China. The group decided there was a need to investigate further various techniques of storing *Azolla* as feed for animals and fish.

4. Fish nutrition

Some specific problems mentioned for further study were the grazing habits and *Azolla* intakes of the different fish species, the variability of the protein content of *Azolla* and the need to increase this nutrient for fish growth, the nutrition of fingerlings in *Azolla* systems, and the low productivity of the present *Azolla* strains in the summer months. There is a need to identify strains and conditions for optimum growth of *Azolla* to meet the nutritional requirements of fish. The value of dried and pelleted *Azolla* as a fish food needs to be defined.

A major problem with fish in *Azolla*-rice systems is the sensitivity of fish to some insecticides used, and the toxicity of these insecticides in *Azolla* when harvested and fed to animals. Alternative programs for insect control need to be studied to allow the safe use of *Azolla* as a feed.

5. Ruminants

The only studies available indicate that *A. filiculoides* grown in overcrowded conditions has a low digestibility in sheep. More research is needed on the effects of stage of growth (and chemical composition) on the nutritive value of *Azolla* for ruminants. It was proposed that the most valuable use of *Azolla* may be as a supplement to rations of high fiber content and low digestibility (rice straw, wheat straw). The digestibility and degradability of *Azolla* proteins in the ruminant digestive tract must also be determined.

6. Water pollution

Azolla may also be used to accumulate macro-and microelements from sewage effluent and polluted water. For both health and nutritional reasons, this material cannot be fed to animals but may be an additional source of digesta in methane production units.

7. Economics of *Azolla* use

Until a precise description on the nutritive value of the various species and strains of *Azolla* is obtained, it is not possible to evaluate the economic benefits of *Azolla* as a source of feed for livestock.

Group III

Taxonomy and sporulation of *Azolla* and germplasm collections

Recommendations

1. A sound taxonomic framework for *Azolla* should be established, using morphological, cytological, ultrastructural, and chemotaxonomic methods;
2. Essential basic and applied research on factors inducing sporulation must be continued, and extended to include development and germination;
3. Methods for the long-term maintenance of germplasm collections must be actively sought;
4. A central, coded register of all *Azolla* culture collections should be compiled and maintained at IRRI or some other appropriate location;
5. A short information booklet on the taxonomy, morphology, and life cycle of *Azolla* should be published by IRRI for training purposes;
6. An *Azolla* newsletter should be published quarterly and widely circulated; and
7. An international workshop on *Azolla* should be held in 1988.

Basic aims

1. To provide vegetative material and sporocarps of accurately named species and strains of *Azolla* for work in the field and in the laboratory on an international basis, and
2. to work toward the development of new and improved strains.

Furtherance of these aims

A. Taxonomy

Work on basic taxonomy must be maintained and strengthened to determine which species and strains (ecotype) are being used in research work, and to ensure the material remains unchanged. Taxonomic work should be continued and extended using scanning electron microscopy, cytological methods including chromosome analysis, and chemotaxonomic methods (involving, for example, analysis of phenolics, isoenzyme patterns, use of DNA probes, etc.). Work should be done to characterize various strains (ecotypes), as well as species.

**TAXONOMY, MORPHOLOGY,
AND PHYSIOLOGY
OF *AZOLLA-ANABAENA* SYMBIOSIS**

Taxonomy and species recognition in *Azolla* Lam.

D.G. DUNHAM AND K. FOWLER

Department of Biological Sciences

Portsmouth Polytechnic

Portsmouth PO1 2DY, Hants., United Kingdom

Azolla taxonomy is confused by inadequate recognition and description of species, which results in difficulties in identification. A critical reevaluation of vegetative and reproductive features of section *Azolla* is being undertaken, using light microscopy, thin-sectioning, scanning electron microscopy, and transmission electron microscopy. The work involves examining extensive collections from the world's major herbaria, including type specimens and living material. Preliminary results indicated that, apart from leaf trichomes and possibly root anatomy, vegetative characters are not useful. Reproductive characters, particularly glochidial septation, sporoderm structure, and other characters associated with the megaspore apparatus, provide the most useful tools for taxonomic separation. Taxonomic changes foreseen include establishing at least two new species, rejecting *A. caroliniana*, and separating *A. filiculoides* into two subspecies.

The experimental use of *Azolla* has promoted the maintenance of cultures of the different species. Difficulties in attributing specimens to certain species in section *Azolla*, with subsequent incorrect determination, limit the usefulness of results obtained. When source material for culturing is not fertile, identification may rely solely on vegetative features if the culture material never produces sporocarps. Even with fertile source material, infertility could result from culture conditions, again providing limited characters for accurate species determination. Although several identification keys are published, which include vegetative and reproductive features (5, 11, 12, 13), too much reliance is placed on characters whose nature and variability have never been critically evaluated. Type material, on which the identity of all specimens is based, has been consistently neglected in many morphoanatomical studies, as has examination of large worldwide collections of specimens from differing environmental situations (5, 6, 7, 8, 9, 10, 11, 13). This has led to some taxonomic confusion, inadequate recognition and description of species and, as a result, difficulties in species identification.

The nature of the taxonomic confusion in section *Azolla* is summarized in Figure 1. Early rationalization of described species by Mettenius (6) recognized only *A. microphylla*, *A. caroliniana*, *A. cristata*, *A. magellanica*,

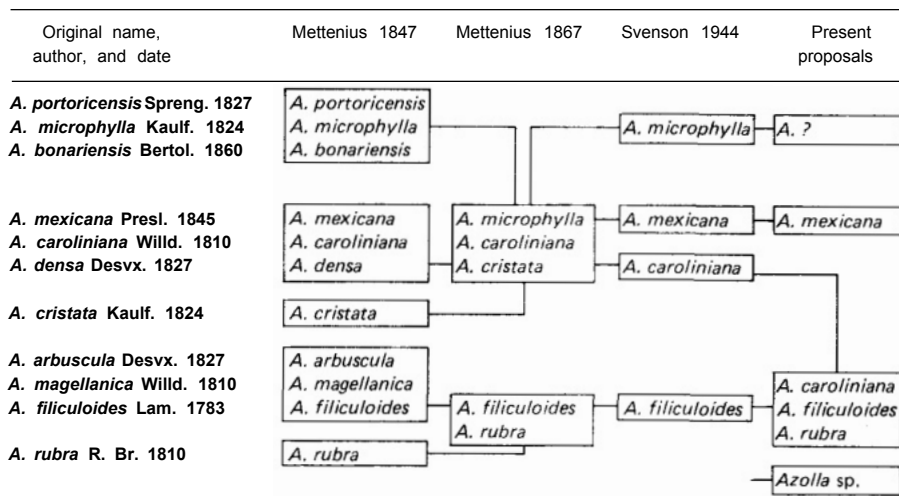
1. Taxonomy in section *Azolla*: previous recognition of taxa and current proposals.

and *A. rubra*. He later combined *A. microphylla*, *A. caroliniana*, and *A. cristata* into *A. caroliniana*, at the same time placing *A. magellanica* and *A. rubra* into *A. filiculoides* (7). Svenson (11), apparently disregarding Mettenius (7), reestablished *A. microphylla*, *A. mexicana*, *A. caroliniana*, and *A. filiculoides* as distinct species. Pre-1944 publication and identification of herbarium specimens are based on Mettenius' work whereas, with a few exceptions, later work follows Svenson (11). As a result, *A. caroliniana* sensu Mettenius (7) is considered equivalent to *A. mexicana*, *A. microphylla*, and *A. caroliniana* sensu Svenson (11), the latter being redefined from vegetative features and glochidial septation, the megaspore apparatus not ever having been found.

Because knowledge concerning the taxonomy of *Azolla* is inadequate, the Portsmouth Polytechnic research program aims to critically assess vegetative and reproductive characters, using light microscopy, thin sectioning, scanning electron microscopy (SEM), and some transmission electron microscopy (TEM), to clarify species recognition and establish a stable taxonomic framework. Type specimens form an essential part of the study, which includes extensive examination of herbarium material from the world's major herbaria, and of living material from the International Rice Research Institute and other sources. We discuss preliminary results concerning section *Azolla*.

RESULTS AND DISCUSSION

Vegetative characters

It has long been accepted that relatively few vegetative characters are useful in separating *Azolla* species. The characters commonly used have never been critically evaluated, particularly those associated with branching pattern and leaf size and shape. A survey of some 120 herbarium specimens incorporating

all known species revealed considerable overlapping of character states and indicated that certain species of *Azolla* are vegetatively polymorphic. As a result, species in section *Azolla* can possess very similar features and are difficult to separate using those characters. Cultured material of *A. filiculoides* and *A. microphylla* grown at Portsmouth are separable only when certain growth stages prevail, these possibly being environmentally controlled. Previously inferred by Lumpkin and Plucknett (5) with their use of *immature* and *mature* growth morphologies, our studies suggest no unequivocal evidence that changes in frond and leaf shape and frond orientation are associated with sporulation. The continuous nature of these changes further decreases the usefulness of these characters in taxonomic separation. The subjective nature of leaf color and observed variability render color a most unreliable character.

Root morphology again offers few useful characters. Distribution and number of root hairs and coiling of the root tip were previously considered useful. However, observations from the present study suggest that these characters are environmentally controlled and therefore unreliable. Recent work by Tan (unpubl.) and this study suggest that root anatomy, particularly the ratio of epidermal cells to cortical cells, may be the only useful means of identifying *Azolla* species by root characters. Promising results have been obtained from a small sample, but variation may limit the significance of the character with more extensive examination.

The most useful vegetative character in section *Azolla* is associated with the trichomes on the adaxial surface of the dorsal leaf lobe. In section *Rhizosperma* (Meyen) Mettenius, which includes *A. pinnata* R.Br. and *A. nilotica* Decaisne ex Mett., these trichomes also extend onto the stem surface. First noted by Mettenius (7), trichomes were not used in species recognition until the work of van Ooststroom (13). Of particular importance is the number of cells comprising the trichome. In *A. filiculoides* it is one-celled, with two or more cells in other species (Fig. 2). Fortunately, trichomes can be examined in dried herbarium specimens so providing information on Type specimens. The present work shows that the Type specimens of *A. caroliniana* and *A. microphylla*, although differing in size from the Type of *A. filiculoides*, possess similar one-celled trichomes. This, coupled with the considerable vegetative variation observed in *A. filiculoides*, indicates that the names *A. caroliniana* and *A. microphylla* may be considered synonymous with *A. filiculoides*. Furthermore, our studies of herbarium material reveal that only plants attributable to *A. filiculoides* appear to be native to the Type localities. It is also of interest to note that the fertile Type specimen of *A. microphylla* shows a megaspore and glochidial characters of the *A. filiculoides* type.

REPRODUCTIVE CHARACTERS

Reproductive structures occur in pairs (fours in *A. nilotica*), a pair of sporocarps consisting of two megasporocarps, two microsporocarps, or one of each. There appears to be no taxonomic significance in the ratio of megasporocarps to microsporocarps. On examination, the sporocarp wall

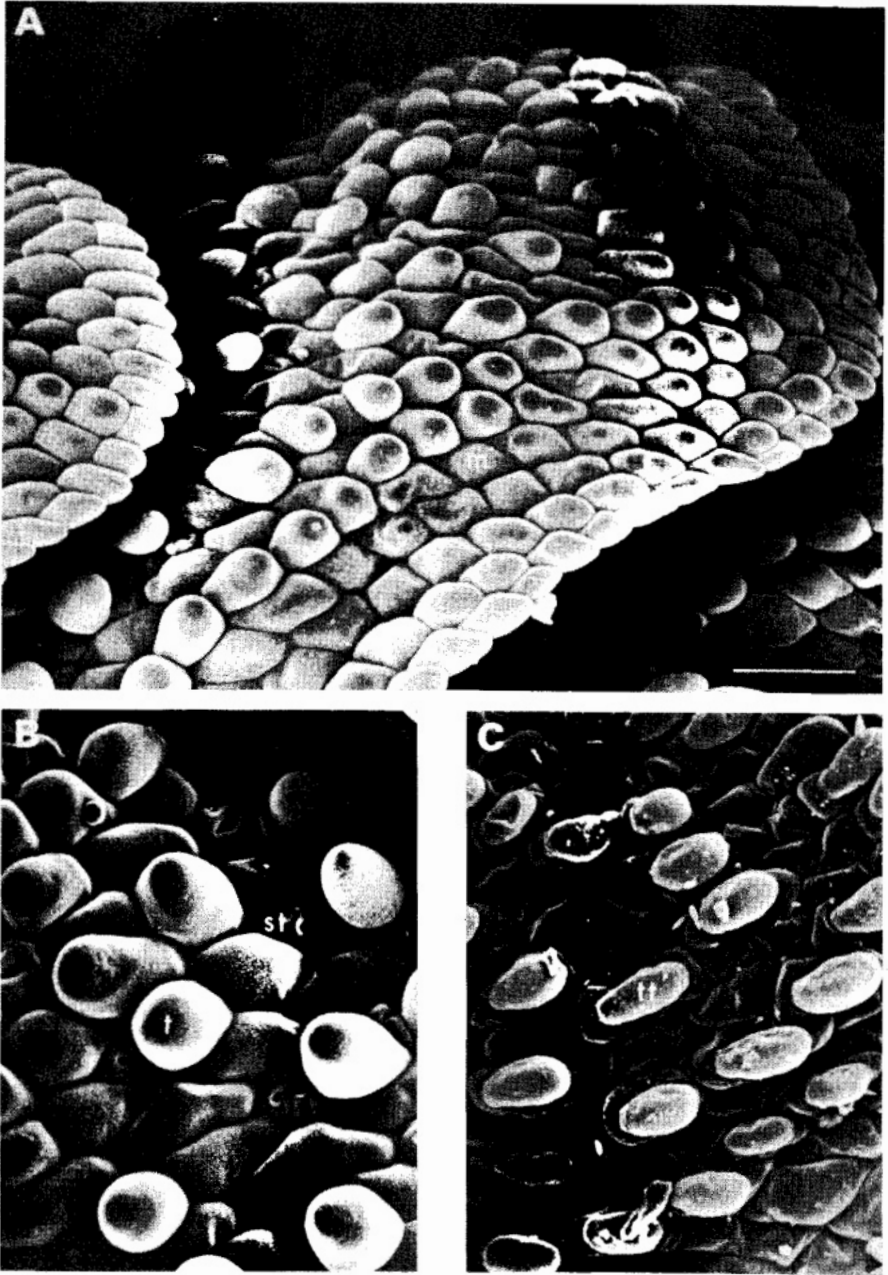

2. Scanning electron micrograph of abaxial surface of dorsal leaf lobe showing appearance of trichomes in fresh material of section *Azolla*. A) *A. filiculoides*—entire leaf lobe showing flattened hyaline margin and trichomes over rest of surface (scale: 1000 μm). B) *A. filiculoides*, showing one-celled trichomes and adjacent stomates (scale: 10 μm). C) *A. mexicana*, showing two-celled trichomes (scale: 10 μm). Legend: m = hyaline margin, st = stomate, t = one-celled trichome, tt = two-celled trichome.

appears similar in all species. The larger microsporocarps accommodate a few to many microsporangia each containing massulae with embedded microspores. Quantitative analysis of number of massulae per microsporangium indicates that this character is of no taxonomic value. Surface ornamentation of the massula, although variable, can be used to distinguish *A. filiculoides*, *A. mexicana*, and *A. microphylla* under SEM. The nature of massula processes has long been used to separate section *Rhizosperma*, where they are trichomelike, and section *Azolla*, with glochidiate processes. The present study considered shape of glochidial shaft and apex, length of glochidium, and number of septa. Of these, only apex shape seems not useful. Glochidial length and number of septa were scored quantitatively and, contrary to reports (2 and others), the latter character is of some significance (see Fig. 3B, D, F, H). Useful features of the megaspore apparatus include perforation of float surface, collar morphology (sectional view), sporoderm sculpturing, and sporoderm structure, the latter being of greatest taxonomic value. It has been possible to evaluate the significance of other reproductive and vegetative characters by correlation using features of sporoderm structure. In addition, the critical nature of the present investigation has enabled the recognition of four main types of megaspore apparatus in section *Azolla* (see Fig. 3A, C, E, G), together with two other megaspore types in section *Rhizosperma*. These megaspore types should not be confused with nomenclature types. The main types of megaspore apparatus and sporoderm structure are illustrated in Figures 4 and 5.

TENTATIVE TAXONOMIC CONCLUSIONS AND PROPOSALS

Apart from leaf trichomes and possibly root anatomy, vegetative features provide little assistance in taxonomic separation. Like previous authors (1, 3, 4), we confirm that, despite variations observed, features of the megaspore apparatus are the most reliable means of separating taxa within *Azolla*. Undoubtedly, for accurate species determination of culture collections, source material should be fertile and herbarium sheets prepared for further reference. The six main megaspore types are recognized as belonging to *A. filiculoides*, *A. mexicana*, *A. microphylla*, and *Azolla* sp. within section *Azolla*, and *A. pinnata* and *A. nilotica* in section *Rhizosperma*. Within the *A. filiculoides* megaspore type at least two subtypes can be distinguished: *A. filiculoides* subtype *rubra* confined to western and south western Australia and New Zealand, and *A. filiculoides* subtype *filiculoides* exhibits a cline of variation, possibly because of its wide geographical distribution. It is proposed to divide *A. filiculoides* into the two subspecies *A. filiculoides* subspecies *rubra* and *A. filiculoides* subspecies *filiculoides*, providing new descriptions in a future publication. Evidence from the present investigation indicates that *A. caroliniana* can no longer be justifiably regarded as a distinct species but should be considered synonymous with *A. filiculoides*. *A. mexicana* occurs in central and eastern North America extending north to British Columbia and

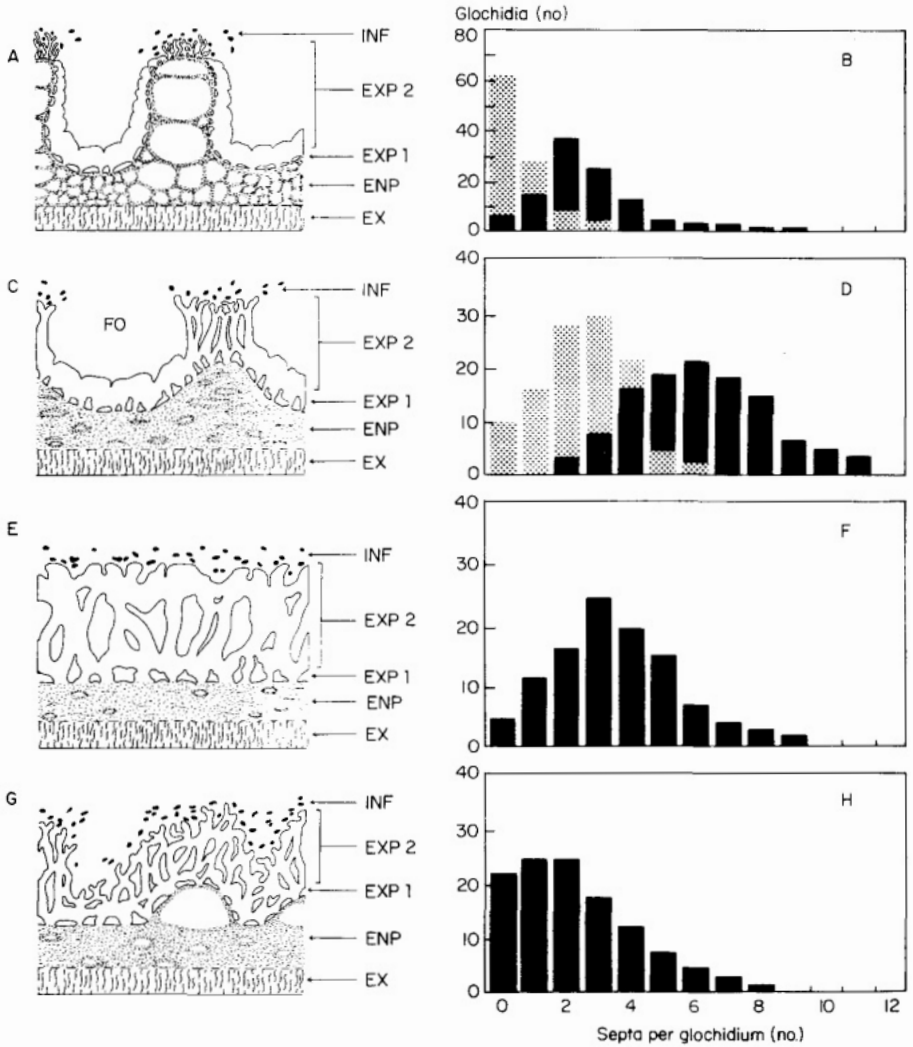

3. Sporoderm structure in the main megaspore types and correlation with glochidial septation. A) Structure of subtype *filiculoides* (sporoderm structure in the subtype *rubra* differs in the nature of the endoperine). B) Histogram illustrating glochidial septation in the subtype *filiculoides* (hatched) and subtype *rubra* (plain). C) Sporoderm structure, *A. mexicana*. D) Glochidial septation, *A. mexicana*. The hatched and plain parts of the histogram indicate that two subtypes may be present; this is not confirmed by sporoderm structure. E) Sporoderm structure, *A. microphylla*. F) Glochidial septation, *A. microphylla*. G) Sporoderm structure, *Azolla* sp. H) Glochidial septation, *Azolla* sp. Sporoderm structure: ENP = endoperine, EX = exine, EXP 1 = exoperine 1, EXP 2 = exoperine 2, FO = fovea (a hollow in the sculpturing), INF = infrafilosum.

south to Mexico, Central, and northern South America. Examination of Type specimen should be placed in synonymy with *A. filiculoides*, thus rendering the name *A. microphylla* invalid. This paper draws attention to the necessity

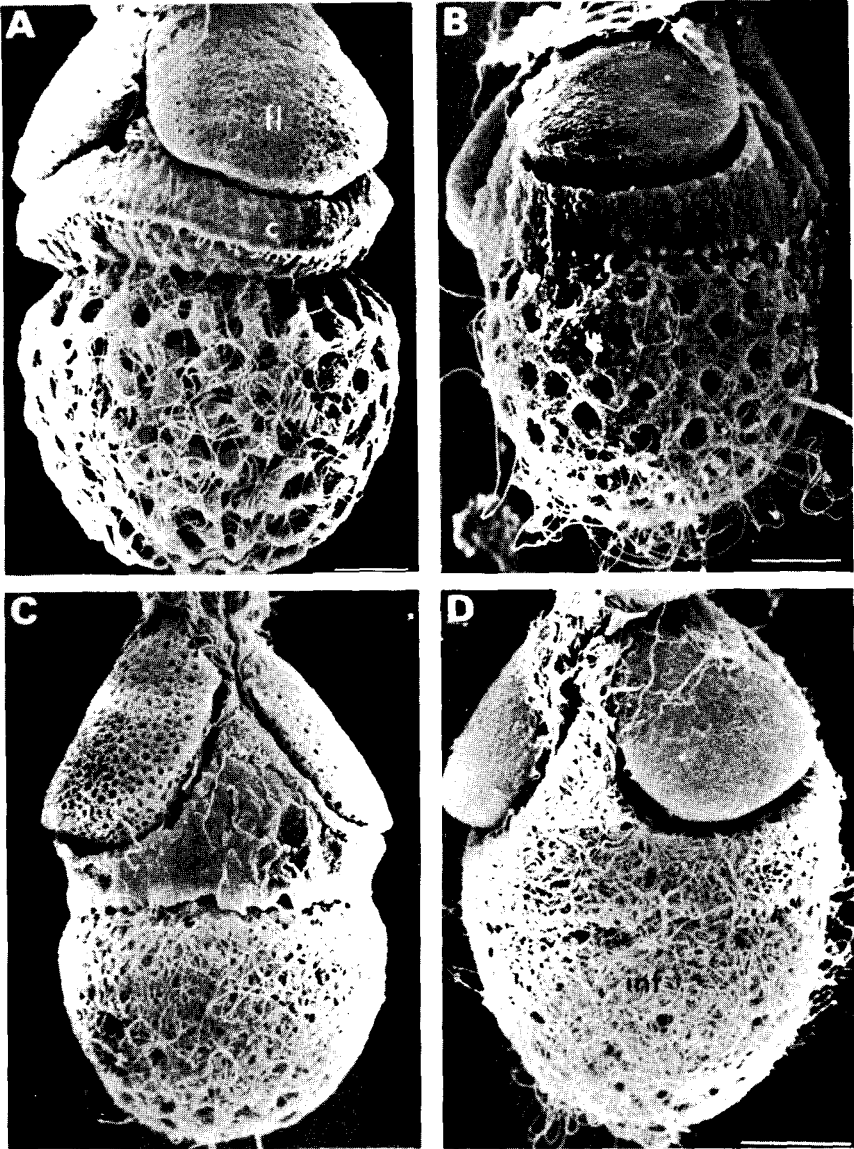

4. Scanning electron micrograph of main types of megaspore apparatus in section *Azolla* (scale: 100 μm). A) *A. filiculoides*. B) *A. mexicana*. C) *A. microphylla*. D) *Azolla* sp. Legend c = collar region, fl = float, inf = infrafilosum, s = sculpturing of exoperine.

for a nomenclatural change; it is intended to designate a new Type specimen and publish a new name with description for the species. Specimens with the *A. microphylla* megaspore type are found in Central and northeastern South America. Specimens with megaspore types attributed to *Azolla* sp. are located

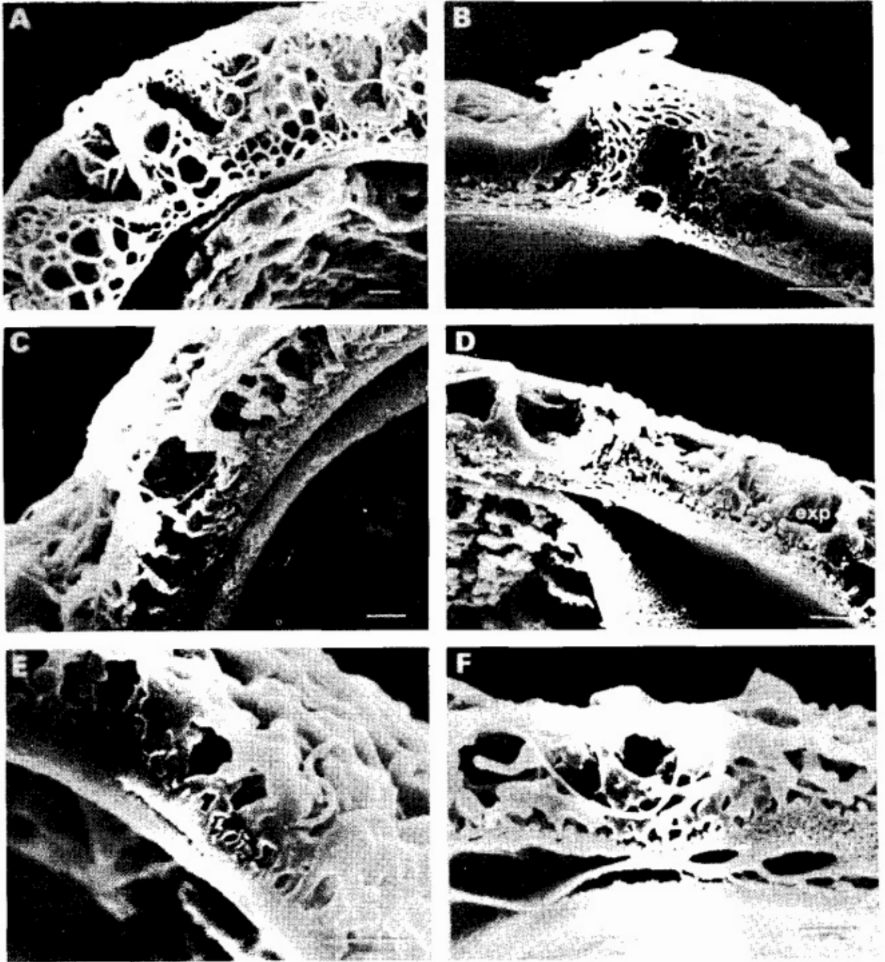

5. Scanning electron micrograph of main types of sporoderm structure in section *Azolla* (scale: 10 μ m). A) *A. filiculoides* (subtypic *filiculoides*). B) *A. filiculoides* (subtypic *rubra*). C) and D) *A. mexicana* (showing structural variation). E) *A. microphylla*. F) *Azolla* sp. Legend: ex = exine, enp = endopertine, exp = exopertine.

in regions where the distribution of *A. filiculoides* and *A. mexicana* in North America, and of *A. filiculoides* and *A. microphylla* in South America, overlap. *Azolla* sp. exhibits more variation in sporoderm structure compared with other taxa, appears to have a disjunct distribution, and has characters intermediate between other species. This disjunct distribution may imply that there are two distinct species which could have been derived as a result of hybridity. No nomenclatural Types exist with features of *Azolla* sp.; when more information is available, one or more new species will be described. Our preliminary proposals regarding the taxonomy of section *Azolla* may be seen

in Figure 1. The present program does not include detailed investigation of *A. pinnata* and *A. nilotica*. However, a preliminary study is being made of the nomenclatural Types together with a small number of other populations. Early indications suggest that vegetative variation may be as great as in section *Azolla*, supporting the observations in sporoderm structure described in *A. pinnata* by Zhou Zhiyan (14).

This paper outlines the preliminary results of this investigation. A stable taxonomic framework for *Azolla* with more precise species recognition will emerge with the publication of descriptions of all known, and any new, species in section *Azolla*; this is already in preparation. The current program relies on herbarium material to furnish specimens collected worldwide and from differing environmental conditions. We intend to extend this program to include a detailed study of *A. pinnata* and *A. nilotica* in section *Rhizosperma*, using both living and herbarium material. Further extension will adopt a more applied taxonomic approach and will concentrate on cultured material, the stability of characters being tested by environmental manipulation. In conjunction with this, chromosome numbers and possibly a phylogenetic approach using a breeding program can be employed. Such close examination of living material may eventually provide a suitable key for identification based on vegetative and reproductive features. Whatever experimental program, the taxonomist can advise on the correct identity of *Azolla* species used, and monitor any morphological or anatomical changes induced by the experimental method or environment.

ACKNOWLEDGMENT

The authors thank Portsmouth Polytechnic for the research assistantship awarded to D.G. Dunham.

REFERENCES CITED

1. Fowler, K., and J. Stennett-Willson. 1978. Sporoderm architecture in modern *Azolla*. *Fern Gaz.* 11(6):405-412.
2. Godfrey, P.K., G.W. Reinert, and R.D. Houk. 1961. Observations on microsporocarpic material of *Azolla caroliniana* Willd. *Am. Fern J.* 51(2):89-92.
3. Kempf, E.K. 1969. Elektronen mikroskopie der Sporodermis van Kanozoischen Megasporen der Wasserfarn-Gattung *Azolla*. *Palaeontol. A.* 43(1/2):95-108.
4. Kempf, E.K. 1969. Elektronen mikroskopie der Megasporen van *Azolla tegeliensis* aus dem altpleistozan der Niederlande. *Palaeontogr. B.* 128:167-179.
5. Lumpkin, T.A., and D.L. Plucknett. 1982. *Azolla* as agreen manure: use and management in crop production. Westview Press, Colorado, USA. 230 p.
6. Mettenius, G. 1847. Ueber *Azolla*. *Linnaea* 20:259-282.
7. Mettenius, G. 1867. Filicinae. Pages 51-54 in *Plantae Tinneanae*. Vienna.
8. Meyen, F.J.F. 1836. Beitrage zur kenntniss der Azollen. *Nova. Acta (Leop.)*. 18(1):507-524.
9. Pieterse, A.H., L. de Lange, and J. van Vliet. 1977. A comparative study of *Azolla* in the Netherlands. *Acta Bot. Neerl.* 26(6):433-449.
10. Strasburger, E. 1873. Ueber *Azolla*. Hermann Dabis. Jena.
11. Svenson, H.K. 1944. The New World species of *Azolla*. *Am. Fern J.* 34(3):69-84.

12. Tryon, R.M., and A.F. Tryon. 1982. Ferns and allied plants: with special reference to Tropical America. Springer-Verlag, New York. 857 p.
13. van Ooststroom, S.J. 1948. *Azollaceae*. Pages 79-80 in Flora Neerlandica. I. Pteridophyta, Gymnospermae. Amsterdam.
14. Zhou Zhiyan. 1983. Quaternary record of *Azolla pinnata* from China and its sporoderm ultrastructure. Rev. Palaeobotan. Palynol. 39:109-129.

DISCUSSION

KULASOORIYA: Were, the megasporocarps whose wall structure was compared, of comparable development stage or maturity?

DUNHAM: Yes, to ensure examination of mature megasporocarps only, the largest ones were scheduled for examination. Immature megasporocarps are normally easily recognized by the megaspore apparatus not filling the sporocarp, collapsed floats, and small basal region.

Comparative study of the morphology, anatomy, and phylogenesis of megasporocarps in sections *Euazolla* and *Rhizosperma*

HE GUO-FAN AND LIN YUE-CHAN

Department of Biology

Zhongshan University

Guangzhou, Guangdong, China

The morphology, anatomy, and phylogenesis of megasporocarps in *Azolla imbricata* Nakai (section *Rhizosperma*) and *A. filiculoides* Lam. (section *Euazolla*) were compared. Megasporocarps of *A. imbricata* are larger than those of *A. filiculoides*, measuring about 650 μm diam longitudinally and 400 μm equatorially. On the basis of morphology and function, the megasporocarp of *A. imbricata* can be divided into four parts: 1) funnel, 2) floating group, 3) spore sac, and 4) megaspore. The megasporocarp of *A. filiculoides* can be divided into five parts: 1) funnel (top), 2) floating ring (consisting of three massulae surrounding the neck), 3) annulus (middle), 4) spore sac (bottom), and 5) megaspore (inside spore sac). The phylogenetic significance of section *Rhizosperma* is also discussed. Our views are contrary to those of Hills, assuming that section *Rhizosperma* might give rise to section *Euazolla*.

MATERIALS AND METHODS

Plants of *Azolla imbricata* and *A. filiculoides* were cultured in ponds of Zhongshan University. Megaspores were collected in August 1981. The samples were fixed with 3% glutaraldehyde and 2% formaldehyde in 0.2 M phosphate buffer (pH 7.4). After washing in buffer, the fixed materials were dehydrated in a graded alcohol-xylene series (50-100%), and embedded in paraffin medium for sectioning at 30-50 μm with a steel knife on a rotary microtome. Materials were mounted on copper studs with silver cement. The paraffin was removed with xylene and the dried materials were coated with a gold layer of about 30 nm using an Eiko IB-3 ion coater. The studies were made with a Hitachi S430 scanning electron microscope.

RESULTS

The megasporocarps of *A. imbricata* are elliptical. They are about 650 μm longitudinal diam and 400 μm equatorial diam. The top of the megasporocarp apparatus is cone-shaped and the bottom is spherical. The megaspore apparatus of *A. imbricata* is larger than the megaspore apparatus of *A. filiculoides*. They differ in appearance. The *A. filiculoides* megaspore apparatus looks like a long pear. The diameters of middle collar and basic sporoderm are nearly equal. Its longitudinal diameter is about 560 μm , and equatorial diam is about 304 μm . Before the megasporocarp matures, it is enclosed within the sporocarp wall. Only one megaspore apparatus develops. At maturity, the middle part of sporocarp wall splits laterally. The back half-part falls first, while the dark forward half-part, which looks like a cone, remains tightly connected to the top of megaspore apparatus (Fig. 1.2, 2.1), until the sporeling germinates. Sporocarp wall protects the development of the megaspore apparatus. The forward half-part also protects the young sporeling. When the back half-part of the indusium falls off, access to the spore sac is provided for fertilization by the male gametophyte or sperm. It is specially clear in *A. filiculoides* (Fig. 2.9). Based on the morphological structure and function, a naked megaspore apparatus of the megasporocarp of *A. imbricata* can be divided into four parts: 1) the suprafilosum at the top, 2) the floating group in the middle, 3) the sporoderm at the bottom, and 4) the megaspore within it (Fig. 1.1, 1.4). The megaspore apparatus of *A. filiculoides* can be divided into five parts: 1) the suprafilosum at the top, 2) a floating ring at the neck, 3) the collar at the middle, 4) the sporoderm, and 5) the megaspore at the bottom (Fig. 2.1, 2.8),

Suprafilosum

The suprafilosum is at the top of megaspore apparatus. Before maturity it resembles the collar of a shirt (Fig. 1.3,F; 2.6). After maturity, the collar expands forward (Fig. 2.1). It is the route for the sperm to enter and for the sporeling to grow. The suprafilosum is formed by several layers of fibers (1-2 μm in diam). The fibers of the external suprafilosum and floating groups are connected to form a complex. The inner surface of the suprafilosum is like a membrane (Fig. 1.3, 2.2). The center of the suprafilosum is filled with blue-green algae (Fig. 2.6, arrow). The base of suprafilosum is columella which extends backward to connect with the top of sporoderm (Fig. 1.4, straight arrow, 2.6). The columella is surrounded by three upper floats. The wall of the columella is thin and its external surface is lined with several layers of fibers linked with the floats. The morphological structure of the suprafilosum in *A. imbricata* is the same as in *A. filiculoides*.

Floating group

Most researchers consider that *Azolla* can be divided into two sections, *Euazolla* and *Rhizosperma*. The megaspore apparatus of *Euazolla* consists of

three floats. Its massulae of microsporocarps are equipped with glochidia. The Rhizosperma has nine floats, and its massulae are flagella. The numbers and morphology of the floats are important taxonomic features. The nine floats of *A. imbricata* can be divided into three groups of threes arranged as a triangle, and the three groups of floats surround the top and the middle parts of the megaspore apparatus (Fig. 1.4). The distance between two floating groups is about 25 μm , numerous fibers are scattered above it (Fig. 1.1, 1.3). The three upper floats surrounding the suprafilosum constitute about 1/3 the height of the megaspore apparatus; the six lower floats in the middle are also 1/3 the height of the megaspore apparatus, and are the largest cross section (Fig. 1.1, 1.5). The nine floats are similar in shape and size, but have a different arrangement. The top of the float is shaped like a tongue, its bottom thicker, forming a tetrahedron. The external and internal surfaces of each float are symmetrical, and its left and right sides mirror each other. Three floats in the same group form a triangle, the upper float is at the top, two lower floats connect with each other (Fig. 1.1). An upper float, with its inner surface and side view, is shown in Fig. 1.6. The maximum length of a float is 240 μm and maximum thickness is 150 μm . Concave spots and stripes are scattered irregularly on the surface of each float. The center of each float has a 12- μm -diam hole (Fig. 1-7) which may be the trace of its organ development. The inner structure of all the floats is like an alveolate. The top of the inner surface of the float is joined with many fibers, which connect with the suprafilosum and sporoderm to form a complex. The bottom of the float is not linked with fiber, so that it can swell upward. The functions of the float are still unknown. The three upper floats may be involved with expanding and opening of the suprafilosum. The functions of the six lower floats are swelling, thus causing the sporocarp wall to explode, and to close the exit of the columella for sporeling growth.

The floats of *A. filiculoides* are smaller, with a longitudinal diam of 170 μm and equatorial diam of about 80 μm . The three floats surround the neck of the megaspore apparatus, their position and arrangement are similar to those of the upper floats of *A. imbricata*, but the bottom of the float is attached to the collar (Fig. 2.1, 2.4). Figure 2.7 shows the cross section and inner structure of *A. filiculoides*. The floating surface of Euazolla is smooth with many small holes of different shapes and sizes scattered on it; some of them have a regular appearance (Fig. 2.2., 2.3). No holes were seen at the center of the external surface of the float. Most investigators who have reported fossil information of floats in *Azolla* describe the shapes and sizes of floats differently than ours. Whether to use the characteristics of floating surface to express the taxon of *Azolla* is an interesting question.

Collar

The collar is a special structure of the megaspore apparatus in Euazolla. It is located at the middle of the megaspore apparatus and has a smooth surface (Fig. 2.4) with an equatorial diam of 250-300 μm . The longitudinal section of



1. The megasporocarp of *A. imbricata*: 1) a megaspore apparatus without indusium (X200); 2) the indusium, split, the forward half-part (W) still connected to the top of megaspore apparatus (X150); 3) the inner surface (F) of funnel in megaspore apparatus and the fibers between two floating groups (X700); 4) longitudinal section of a megaspore apparatus (X200); 5) cross section of the six back-floats (X300); 6) a front-float, showing its inner surface and two sides; 7) the center of floating surface, showing the concave spots and a hole (X1000); 8) a floating group, showing the surface of megaspore apparatus (X200); 9) longitudinal section of the megaspore apparatus, showing the inner surface (M) of

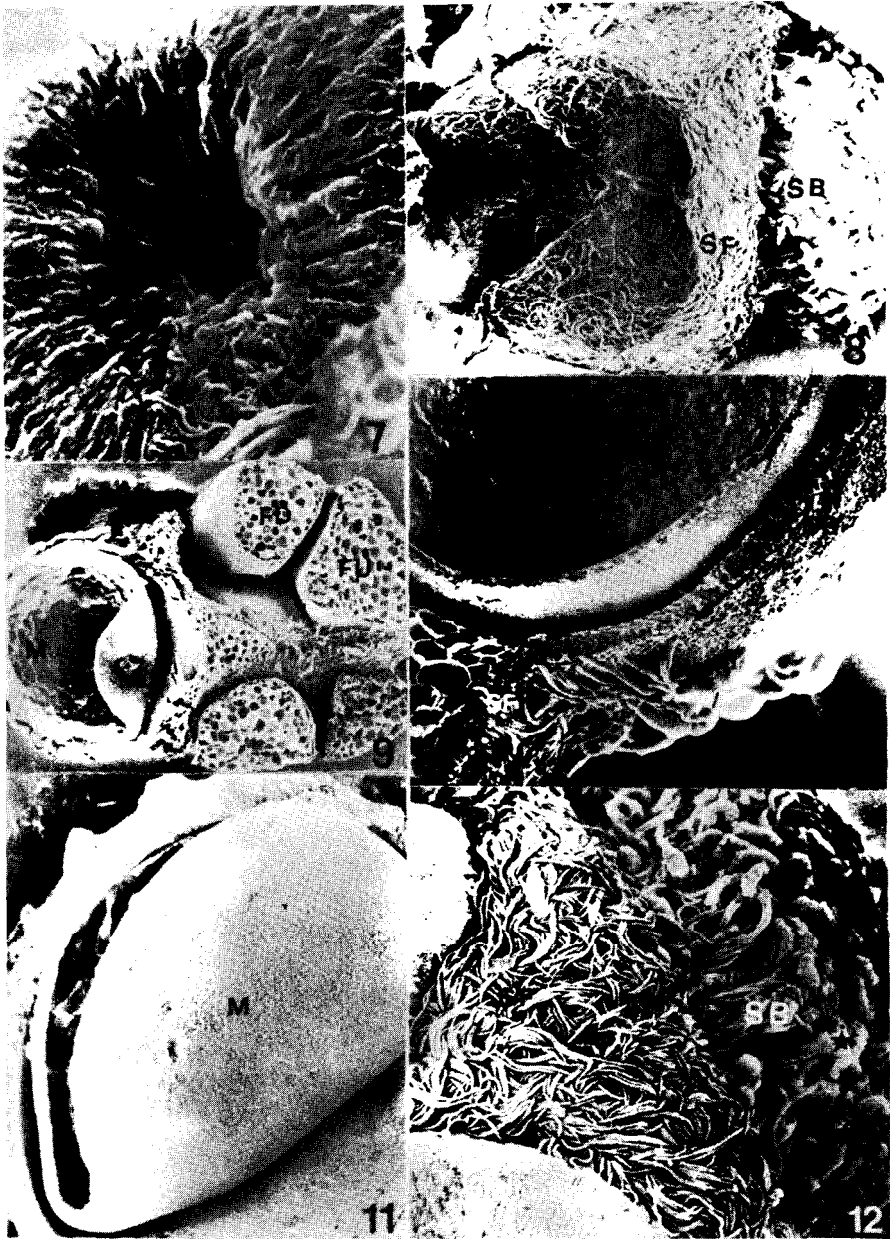

sporoderm (X 150); 10) part of spore sac in longitudinal section, showing the sporoderm and spore sac wall (arrow) (X700); 11) the external surface of sporoderm (M) and the inner surface of spore sac wall (X450); 12) the fibers (SF) in front of spore sac wall and the bulges (star) in base (SB) of spore sac (X700). A = annulus, F = funnel, FD = back-float, FL = float, FU = front-float, G = glochidium, I = inner surface of float, L = left of float, M = megaspore, R = right of float, S = spore sac, SB = base of spore sac, SF = front of spore sac, W = indusium.

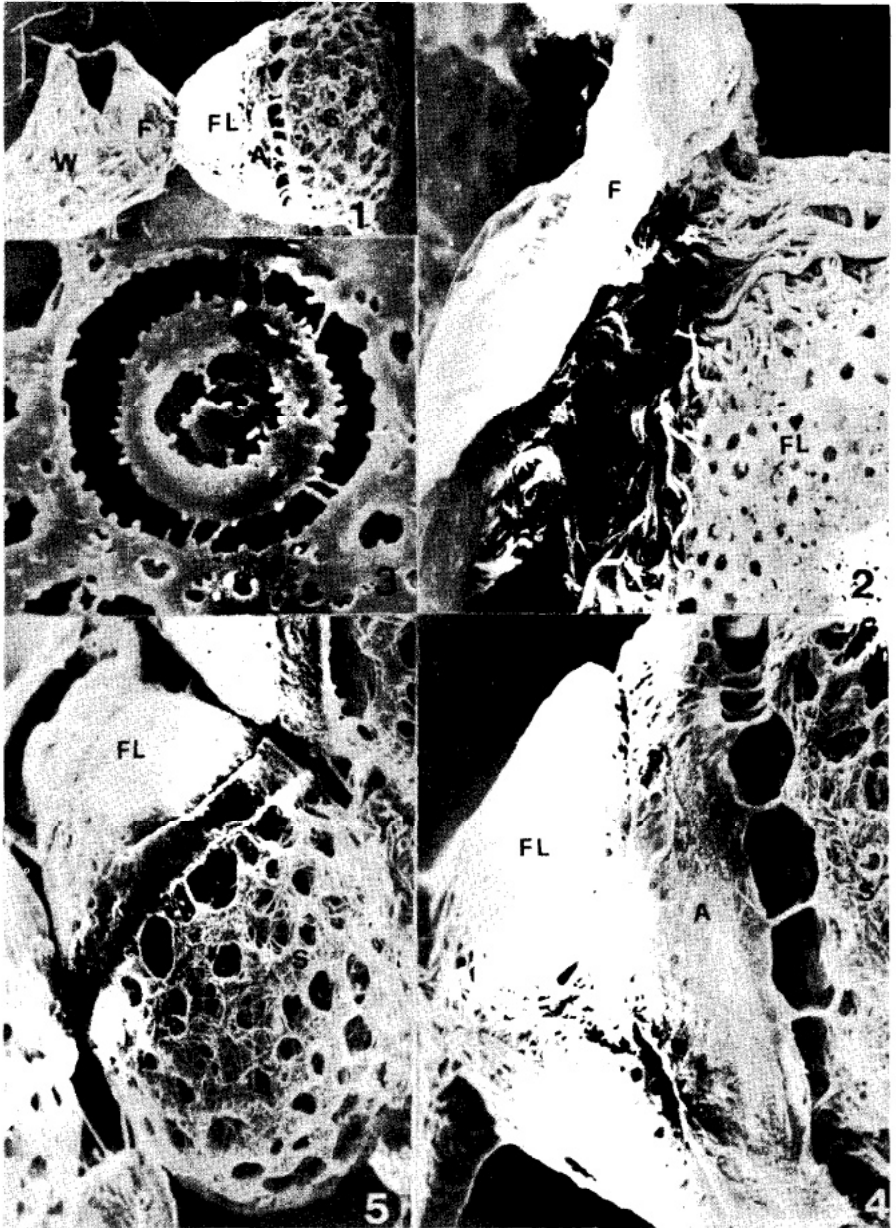

2. The megasporocarp of *A. filiculoides*: 1) a view of megasporocarp, showing the back half-part of indusium that has fallen off (X100); 2) front of megaspore apparatus, showing the fibers of funnel connected with the float (X700); 3) sculpture of floating surface (X5000); 4) the annulus (A) at the middle of megaspore apparatus and two floats (FL) (X300); 5) the fibers and concave hole at the surface

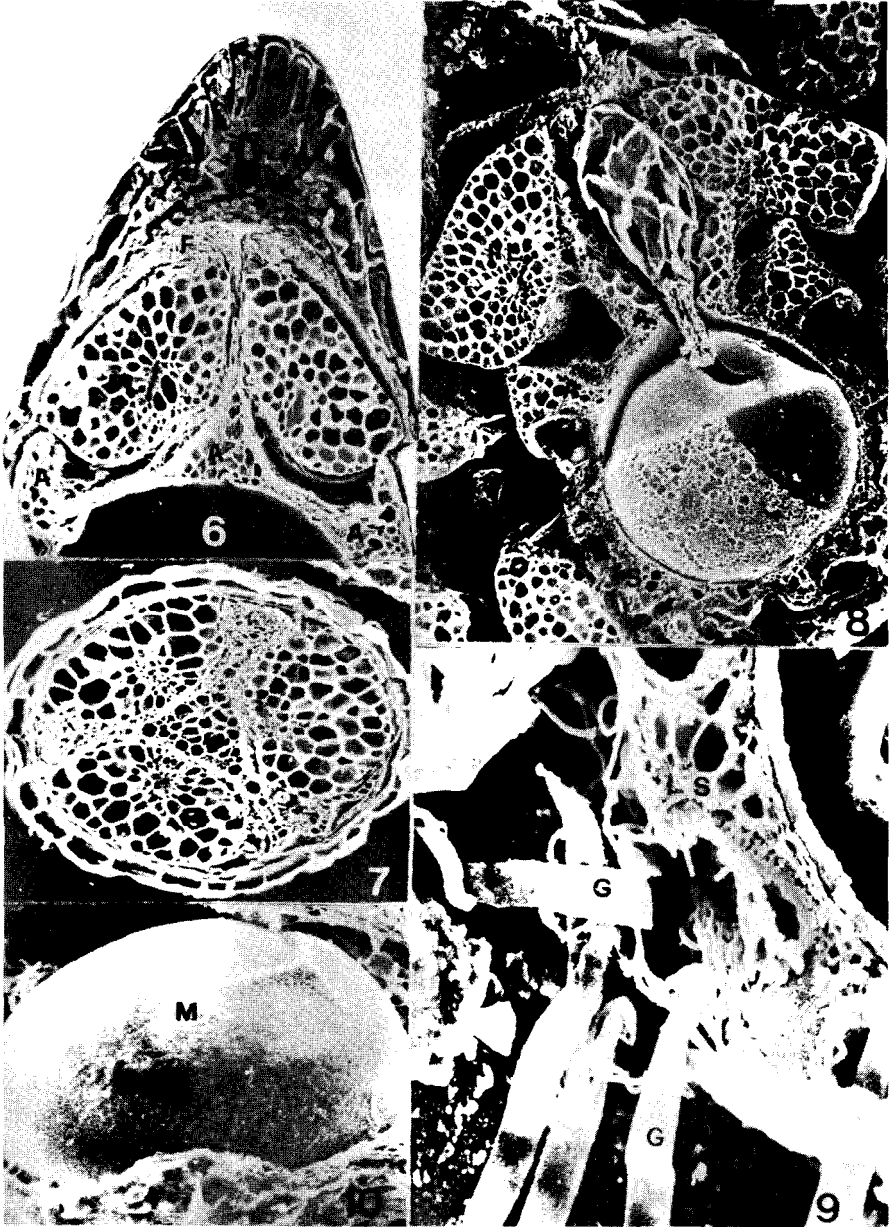

of base spore sac (X200); 6) longitudinal section of front megaspore apparatus, the blue-green algae (arrow) at the center of funnel (X250); 7) cross section of the floating ring (X200); 8) longitudinal section of a megaspore apparatus (X200); 9) the fibers of spore sac connected with glochidium of massulae (X10000); 10) a view of megaspore (M), the triradiate ridge at the top (X300). See Figure 1 for legend.

the collar appears as a "T", and its inner structure appears as an alveolate. Before it matures, the bottom of three floats insert themselves into the collar (Fig. 2.6), and after maturity the floats swell out from the collar (Fig. 2.8). The function of the collar may be to swell and split the sporocarp wall.

Sporoderm

A view of the sporoderm in *A. imbricata* may be observed from the longitudinal section of the megaspore apparatus (Fig. 1.4). The forward half-part of the apparatus looks like the collar of *Euazolla*, but it is surrounded by six lower floats (Fig. 1.4., 1.5), and its surface is scattered with numerous fibers (Fig. 1.8). The back half-part is shaped like a bowl. The sporoderm surface shows no alveolate structure, the thickness of the sporoderm is about 10 μm (Fig. 1.10, arrow). The internal surface of the sporoderm is plane (Fig. 1.11) and connects with the megaspore. The external surface of the sporoderm is irregular with many tubercles (Fig. 1.12, star). The longitudinal diam of the tubercles is 10-30 μm and the cross-section diam is 3-6 μm . The function of tubercles is not understood.

The external surface of the sporoderm of *Euazolla* is encircled with a thick wall (25-45 μm thick) differentiated into 3 layers. Its surface is covered with numerous fibers (Fig. 2.5), which join the glochidia in the massulae of the microsporocarp (Fig. 2.8, 2.9). The surface of sporoderm in *Rhizosperma* has no fibers because the massulae of the microsporocarp are but simple flagella.

Megaspore

The central cavity of the sporoderm is the site where the megaspore grew and developed (Fig. 1.4, arrow; 1.9; 2.8). The spheric megaspore is about 250 μm diam. The thickness of the exosporium is about 3 μm , and from it the differential layers cannot be observed (Fig. 1.10). The surface of the megaspore is smooth, and it has no special sculpture and germination aperture, but it has a triradiated ridge at the top (Fig. 1.11, 2.8, 2.10). Fertilization takes place through this opening and the sporeling subsequently escapes through it.

DISCUSSION

Referring to the phylogenesis in *Azolla*, Hills and Weiner (1) considered that *A. genesiana* was the earliest fossil *Azolla* discovered with three floats in the Cretaceous period. That provides evidence that *Euazolla* may have given rise to *Rhizosperma*. Some other investigators also regard *Rhizosperma* as secondary. But Jain (2) held the opposite view because 1) a great deal of multifloated (15-20 floats) fossils from Upper Cretaceous have been discovered, so the multifloated *Azolla* should be considered the primary; and 2) the fossil materials Hills and Weiner examined were obscure and the structure of the float was not clear.

We proceeded with our analysis in accordance with morphological structures of the megaspore apparatus, and agree with Jain's view. Many evolutionary events proceed from the complex to the simple, but they must be adapted to the environment if the race is to survive. Too many floats would be useless. If the periphery of megaspore has a thick wall to protect the megaspore then it would be peculiar for a multiplied organ to have developed. In addition, the fibers on the surface of the spore sac help fix the massulae of the microsporocarp to facilitate fertilization. The flagella evolve into the glochidia to facilitate the species breeding. That the useless structures were simplified and the useful structure was perfected is consistent with natural selection.

From the sequence of ontogenesis, the precursors of floats were sporangia inside the sporocarp. After megaspore had developed, other sporangia then formed the other parts of the megaspore apparatus. Given that ontogeny recapitulates phylogeny, an original species with multifloats is a reasonable assumption. Some of the sporangia that developed earlier in the evolutionary cycle coalesced to reduce the number of floats. In the back-floats of *Rhizosperma*, we have often seen a float divided into two. Sweet and Hills (3) also reported this phenomenon. So the megaspore apparatus in *Rhizosperma* sometimes had 10-12 floats of different sizes. It may be a phenomenon of return-to-ancestor. There is also circumstantial evidence for floats evolving from many to few.

According to present morphotaxonomy of *Azolla*, there are at least four species of *Euazolla*, distributed in a wide climatic range. But there are only three known species of *Rhizosperma* (*A. imbricata*, *A. pinnata*, and *A. nilotica*). It is usually thought that *A. imbricata* and *A. pinnata* may be the same species, so the species of *Rhizosperma* remain at only two. *Rhizosperma* not only has fewer species, but its original distribution was limited to the subtropics. Furthermore, although *A. nilotica* has nine floats, its massulae usually have no hairs or flagella. Whether or not they are all in an evolutionary stage, it must be admitted that wide adaptability characterizes biological evolution.

Because *Azolla* generally propagates vegetatively, it cannot produce sporocarps at the same time and at the same locality. It is difficult to do comparative research on the propagative organ. However, this paper relates to taxonomy, physiology, genetics, breeding, and utility of *Azolla*, subjects that should be thoroughly investigated.

REFERENCES CITED

1. Hills, L., and N. Weiner. 1965. *Azolla geneseana* n. sp. and revision of *Azolla primaeva*. Micropaleontology 11(2):255-261.
2. Jain, R. K. 1971. Pre-tertiary records of Salviniaceae. Am. J. Bot. 58:487-496.
3. Sweet, A., and L. V. Hills. 1971. A study of *Azolla pinnata* R. Brown. Am. Fern J. 71:1-13.

DISCUSSION

KANNAIYAN: Could you get much variation in the morphology and anatomy of *Azolla pinnata* var. *pinnata* and *Azolla pinnata* var. *imbricata*?

HE GUO-FAN: I did not conduct a study on this. *A. pinnata* did not produce sporocarps in Guangdong Province.

Methods for using *Azolla filiculoides* sporocarps to culture sporophytes in the field

LU SHUYING

Wenzhou Municipal Scientific
and Technological Commission
Wenzhou, Zhejiang, China

Some practical techniques for using *Azolla filiculoides* sporocarps to raise seedlings in the ricefield are given. The techniques discussed include preparing the seedling bed, seeding, mulching, fertilizing, and floating young seedlings. At a sowing rate of 160 kg sporocarps fresh wt/ha, sporophyte yield at 52 d will range from 15.8 to 21 t sporophytes fresh wt/ha.

In recent years there has been a breakthrough in the main technique of using *Azolla filiculoides* sporocarps to raise young seedlings in the fields. Through it we can overcome the difficulties of survival of the sporophytes through winter in north China, and through summer in the south.

The productivity of *A. filiculoides* sporocarps is dependent on the environment. By applying the ZHG method, the collection rate is 80% or higher, with the highest yield of up to 1 t sporocarps fresh wt/ha. Therefore we can successfully culture sporocarps artificially by adjusting external conditions to the requirements of sporocarp germination and growth.

The process of raising seedlings may be divided into three stages: emergence, nursing, and floating.

1. *Emergence stage.* It requires 7-10 d from seeding until seedlings germinate. During this period sporocarps should be protected from rain, moisture maintained, and light intensity reduced.
2. *Nursing stage.* From 25 to 35 d are required for the seedlings to develop 11 buds. During this period moisture should be maintained, light intensity adjusted, and seedlings fertilized.
3. *Floating stage.* At this stage of development, seedlings may be transferred from wet soil culture to hydroponic culture to speed sporophyte multiplication.

Because these three managerial steps are synchronized to the three growth stages of the seedlings, the status of young seedlings cultured in the field may also be divided into three stages. In the first stage the young seedling grows 1 to 8 leaflets, has no side buds nor evidence of them, appears rather

Table 1. Number of buds at each seedling growth stage in the field culture process.

Sample no.	Buds/sporophyte ^a					
	1-10DAS	11-20DAS	25DAS	30 DAS	35 DAS	40 DAS
1	Buds sprouting	2.1	4.0	6.8	14.1	35.5
2	Buds sprouting	1.0	2.4	4.0	9.3	22.9
3	Buds sprouting	1.0	2.6	4.6	10.1	32.0
4	Buds sprouting	1.0	2.2	6.9	12.7	28.0
Av		1.3	2.8	5.6	11.6	29.0

^a1-10 d after seedling (DAS) is emergence stage, 11-30 DAS is nursing stage, 35-40 DAS is floating stage.

Table 2. Emergence rate of sporocarps in different culture methods.

Method	Seedlings (no.)	Emergence (%)	Remark
Seeding and culturing in floating bed	71	4	Sporocarps usually drift about and gather in large groups.
Seeding in flooded bed, draining water, and culturing in wet bed	218	11	Sporocarps first gather slightly in groups, then are covered with mud, leading to lower emergence rate.
Seeding and culturing in wet bed	530	28	Sporocarps can be distributed evenly.

tender, and grows slowly at an average rate of 0.6-0.7 leaflets/d. In the second stage each seedling having 2-11 buds grows at the rate of 4-7 leaflets/d. In the third stage each sporophyte has more than 11 buds, and multiplies rapidly at an average rate of 15-18 leaflets/d (Table 1).

PREPARING SEEDLING BED

Tests show that the wet culture method is convenient for the germination of sporocarps and the early growing of seedlings. Various seedling beds, due to their different capacities of maintaining moisture and aeration, will produce differently according to culture method (Table 2).

A seedling bed paved with a layer of coarse sand on the paddy soil gives a 19-20% emergence rate; a bed paved with loess soil gives an emergence rate of 15.7-16.6% (Table 3) because of its poor aeration, water percolation, and tendency to harden. When the bed is made of paddy soil only, earthworms kill some seedlings. Therefore, the paddy field used to culture seedlings should have medium fertility and good drainage and irrigation. Beds should be about 2 m wide and of any convenient length. They should be longitudinally separated into three wet plots. After leveling the beds, 24.5-33.0 kg carbofuran/ha may be used to kill underground pests. After insecticide treatment sand can be spread and the bed seeded with sporocarps.

Table 3. Emergence rate of sporocarps in different surface treatment of seedbeds.^a

Seedbed treatment	Seedlings			Emergence rate (%)
	4 Aug	11 Aug	16 Aug	
Paved with loess	80	352	528	16
Paved with fine sand	608	896	704	21
Paddy soil only	112	144	160	5
Coarse sand on paddy soil	400	672	640	19

^a Seeding date, 23 Jul; test period, 25 d; mean moisture, 28.5; temperature, 24-33.5°C.

Table 4. Effect of seeding rate on number of seedlings in field culture.

Seeding date	Seeding rate (kg/ha)	Emergence date	Seedling (no.)/11 dm ²					
			4 Sep	16 Sep	1 Oct	7 Oct	12 Oct	18 Oct
25 Aug	160	1 Sep	309	619				
9 Sep	160	16 Sep		255	700			
22 Sep	80	1 Oct			255		355	
27 Sep	80	5 Oct				109		282

Table 5. Effect of seeding date on number of buds produced.

Seeding date	Buds/seedling				
	20 DAS	25 DAS	30 DAS	35 DAS	40 DAS
25 Aug	—	—	—	—	11.0
9 Sep	1	2.3	3.1	7.9	13.5
27 Sep	1	2.8	5.6	9.4	29.4

DAS = days after seeding.

SEEDING SPOROCARPS

Dressing with soil powders. To seed sporocarps evenly and achieve highest germination, the wet sporocarps should be dressed with dry soil at 15 ratio (wt/wt) before seeding.

Seeding density. Two seeding rates are used, 160 kg wet sporocarps/ha and 80 kg wet sporocarps/ha. Emergence is 20% at the higher seeding rate and 23.1 % at the lower rate. The relation between seeding rate and number of seedlings is given in Table 4.

Seeding time. The effect of seeding rate on seedlings produced was similar for all seeding dates (Table 4). But the growth rate of seedlings differed; those planted later grew faster. The lower temperatures associated with later planting dates are more favorable for seedling growth (Table 5).

MULCHING

After being seeded, the nursery bed must be mulched. A wide range of materials can be used including nylon sheet, oil paper, bamboo curtain,

Table 6. Effect of mulching material on number of buds produced. ^a

Treatment	Natural light (%)	Buds/seedling				
		1 Oct	7 Oct	12 Oct	17 Oct	22 Oct
Bamboo curtain	18	1	2.3	3.1	7.5	14.9
Nylon sheet	69	1	2.0	2.0	6.8	18.7
Bamboo curtain added to nylon sheet	8	1	2.0	2.5	5.6	7.1
Oil paper	0.5	1	1.1	1.2	2.9	4.0
Natural light	100	1	1.9	2.4	6.4	20.3

^aMean value of 9, 13, or 15 h per daylight. Seeding date, 9 Sep 1980.

Zizania leaf, and rice straw. Mulching not only guards against erosion due to heavy rains, but helps maintain moisture and reduce light intensity. Different mulch materials and periods of mulching are required for different planting periods and seedling growth rates. For instance, using oil paper in a herringbone pattern (eave ht 7 cm) is better for keeping out rain, reducing temperature, and reducing sunlight. But seedlings can receive only 0.49% of natural light intensity in the daytime before 0900 h or after 1500 h. This mulch is suitable only in early autumn for 30 d or less.

Bow-shaped nylon sheet with rolled border is best for keeping out rain and preserving moisture, but it admits too intense light and permits too high temperature for optimum seedling growth. It must be supplemented with straw curtains to reduce light and temperature when seeding is done in the early autumn.

Nylon sheet mulching with the border sealed and the two ends left open is suitable for seeding in early spring or in late autumn, because of good light transmission and proper temperature.

No matter what mulching material is used, when the seedlings have reached the stage of 20-30 leaflets (4 or 5 buds), the mulch must be removed progressively to acclimate the seedling to the environment so they can be transferred to wet culture in the field.

The effect of mulching material on growth rate of seedlings is shown in Table 6.

FERTILIZING

Numerous trials have shown that young seedlings require external nutrition as soon as they sprout. N fertilizers promote rapid and even growth. NPK fertilizers give the best effect. For example, manures mixed with phosphorite composts not only provide nutrients for seedlings, but they are a good rooting medium. The effect of phosphonitrogen liquid fertilizer is not so good as that of using phosphorite fertilizer alone, because it promotes the growth of wild algae, which harm the seedlings (Table 7).

Table 7. Effect of fertilizers on seedling growth at the nursing stage.

Treatment	Dose (kg/ha)	Buds/seedling			
		7 Oct	12 Oct	17 Oct	22 Oct
Manure powder	20	2	5.4	8.8	13.2
Phosphorite compost	Calcium superphosphate 40 kg, ash 80 kg, fine soil 28 kg	2	4.1	7.2	8.4
Phosphonitrogen liquids	Urea 3 kg, calcium superphosphate 4 kg, water 815 kg	2	2.8	4.1	5.7
Phosphorite liquids	Calcium superphosphate 4 kg, water 815 kg	2	3.5	4.2	7.8
No fertilizer	-	2	2.4	3.6	5.3

Table 8. Effect on yield of floating seedlings at various growth stages.

Before floating (12 Oct)		After floating (17 Oct)	
Buds/seedling	Yield (t/ha)	Buddseedling	Yield (t/ha)
11.0	4.5	38.2	21.1
-	-	35.4	15.8
4.3	2.6	30.3	9.4
-	-	34.3	8.3

FLOATING SEEDLINGS

Floating seedlings means irrigating the nursery beds to float seedlings to the water surface for transfer into water culture from wet soil. When the seedlings have developed 10 buds and about 50 leaflets, they multiply quickly and may become overcrowded. Therefore they must be floated and transferred to wet culture in time for good growth to continue. In wet culture, 48 d after seeding, seedling yield is 4 t fresh wt/ha. Five days after floating, yields may be as high as 21 t/ha (Table 8). With no floating, yields are only 15.8 t/ha. If seedling yield is less than 4 t/ha, say about 3 t/ha, floating has little effect on rate of growth. The time of floating should be determined by the seedlings' growth period and growth status (yield per hectare). Seedlings may be floated and multiplied early, only if they have been densely seeded and performed well in the nursery.

The floating procedure is as follows. First, irrigate the nursery bed overnight. The next day rake the seedlings free from the soil by hand or with a bamboo rake. Then moisten the seedling with water (except on rainy days) and distribute them evenly over the field beds. If the bed is too long for the number of seedlings, the bed must be separated into smaller plots to prevent seedlings from being gathered into large groups because of the action of wind and rain. This ends the nursery stage and the young seedlings enter the sporophyte multiplication stage. Seedling management from this point on is the same for propagation in the paddy fields.

CONCLUSION

Preventing the nursery bed from eroding due to heavy rain is the key to the success in nursing seedlings in the field. The growth rate of young seedlings varies with the light, temperature, moisture, and fertilization. The timely floating of seedlings speeds growth remarkably. Therefore, we have to integrate these three major techniques in the overall process to effectively use sporocarps to raise sporophytes in the fields. How to enhance the germination rate in the field and how to accelerate the growth rate of young seedlings require further study.

Germination of *Azolla filiculoides* Lam. sporocarps and factors affecting their growth

XIAO QING-YUAN, SHI YAN-RU, YANG GUANG-LI,
AND PENG KE-LIN

Soil and Fertilizer Institute
Academy of Agricultural Sciences
Hunan, China

The study of techniques for the sexual reproduction of *Azolla filiculoides* Lam. should include collection, storage, and sprouting of sporocarps; large-scale cultivation of sporelings, etc. The three processes of sprouting of *A. filiculoides* — germination, greening, and shooting — are described, and the main factors that affect sprouting rate are analyzed. We conclude that 1) only mixed cultivation of fully mature megasporocarps and microsporocarps can lead to sprouting, 2) temperature affects sprouting rate, 3) sunlight is an indispensable condition for sprouting, and 4) cultivation in the dark tends to raise shooting rate.

China has a history of several centuries of cultivating *Azolla* for paddy field green manure (3). For a long time, the Chinese used the clipped lateral branches of the *Azolla* plant for reproduction. However, because the *Azolla* plant is rather weak, it has difficulty surviving winter and summer.

Azolla is a fern plant. Its life cycle is an obvious digenesis of a sporophyte stage and a gametophyte stage. How to master the process of sexual reproduction of *Azolla*, how to cultivate the sporelings of sporocarps, and how to make *Azolla* survive severe cold and intense heat remain major technical problems in applying *Azolla* to production.

To apply the sexual reproduction of *Azolla* to production, it is necessary to solve problems of collecting sporocarps, storing sporocarps, sprouting of sporocarps, and cultivating sporelings on a large scale. Of the four, collecting sporocarps is basic. This article gives a short account of the process of and the conditions necessary for the shooting of *A. filiculoides* sporocarps.

GERMINATION PROCESS

The process of germination of *A. filiculoides* sporocarps includes the formation of male and female gametophytes, combination of eggs and sperms into zygotes, and the growth of embryos.

According to obvious external changes and internal development, the sprouting process of *A. filiculoides* sporocarps may be divided into three periods: 1) germination, 2) greening, and 3) shooting (1).

Germination period

At 20-30 °C, it takes only 3-5 d for *A. filiculoides* sporocarps to develop into female gametophytes. Two or three days after germination begins, the megasporocarps show no obvious change. Absorption of water makes sporocarps swell slightly, and the floats are not yet opened. When the megasporocarps have grown into mature female gametophytes, the floats at the top open outward.

Between the floats are the prothallia of grown female gametophytes. They are colorless and semispherical. Archegonia and eggs grow inside the female gametophytes.

The whole process of microspores growing into male gametophytes takes place in massulae. The period in which microspores fully develop into male gametophytes is almost as long as that of female gametophytes. Upon maturity of *A. filiculoides* microsporocarps, the indusia break and all the layers of sporangia split. The massulae stick to the walls of the megasporocarps. The sperms produced by male gametophytes may escape from the massulae, all the sides of which have gelatinized.

Greening period

At 20-30 °C, sperms unite with eggs leading to the formation of zygotes, which develop into embryos. The process lasts only 2-3 d. In this stage, the most conspicuous external change of megasporocarps is represented by the presence of chlorophyll produced by the cells of female gametophytes in sunlight. As a result, female gametophytes turn light green and swell, stretching out from the shape of a ball to that of a drum. The embryos develop rapidly. Megasporocarps whose female gametophytes do not green nor change color immediately after greening will fail to germinate. The megasporocarps whose female gametophytes look dark green will not germinate either.

Shooting period

When the embryos reach a certain stage of development, the indusia of the megasporocarps are pushed aside and relocated at the top of sporangia, and cotyledons appear. This process takes only 1 or 2 d. Generally, one megasporocarp can produce only one young sporeling from the cervical archegonium at the top of the female gametophyte. But a small number of megasporocarps, if their floats are fully open, may sometimes germinate even 10-15 d after the maturity of the female gametophytes. The young sporelings produced in this way are grown from the sides of the female gametophytes. They are called *side sporelings*. According to Smith (2), the female gametophyte of *Azolla* first develops a cervical archegonium at its top. He says, "If there is no fertilization of the egg in this archegonium, additional archegonial initials

are differentiated lateral to it. If these fail to function, further archegonia are produced until a dozen or more have been formed." Side sporelings come out from the additional cervical archegonium at the side. In the work of cultivation, we have found cases in which one megasporocarp bears two sporelings (two of the same size, or one large and a small one) or even three sporelings. But such cases are few.

CONDITIONS FOR SHOOTING

Degree of maturity of sporocarps

According to their external sizes, colors, and morphological changes, the maturity of *A. filiculoides* sporocarps is divided into three periods: 1) green maturity, 2) yellow maturity, and 3) full maturity.

Green maturity. The megasporocarp wall is light green. The fruit tips are purplish brown or reddish brown. Sporocarps can grow.

Yellow maturity. The megasporocarp wall turns from light green to light yellow. The fruit tips are brown. The lower part of the fruit is brownish red. The fruit no longer grows. At the end of the period, the tops and the bottoms of the megasporocarps turn greenish brown. The floats in the upper and lower parts are light yellow. The fruit walls are intact. The pits in the middle part are visible.

Full maturity. The sporocarps reach full maturity. The tops and bottoms of the megasporocarps are browner. The fruit walls are broken horizontally, presenting a crack. The base of the sporocarp is ball-shaped. There are notable protrusions on the surface.

Experiments show that *A. filiculoides* megasporocarps cannot shoot during green maturity or yellow maturity. In the course of cultivation, only 50-60% of megasporocarps that have outwardly reached full maturity can germinate. About 5-10% of the germinated sporocarps do not bud. The remaining 30-40% do not germinate at all.

The date of collection has much to do with the shooting rate (Table 1). The maturity rate of the seedlings of sporocarps collected from 30 May to 10 Jun is 15-28% higher than that of the sporocarps collected before 25 May. The germination rate is 31-60% higher, and shooting rate is 28-56% higher.

Table 1. The relationship between the date of collection of *A. filiculoides* sporocarps and shooting rate (1).

Collection date	Maturity rate (%)	Germination rate (%)	Shooting rate (%)
25 May	12.0	22.0	8.0
30 May	27.0	53.0	36.0
10 Jun	40.0	82.0	64.0

Mixed cultivation of megasporocarps and microsporocarps

By parthenogenetic cultivation, sporocarps will not shoot. With *A. filiculoides* no case of parthenogenesis has been found.

Under conditions of parthenogenetic cultivation, most megasporocarps can germinate. The floats open. Part of the female gametophytes appear green but they do not shoot. If the male and female gametophytes are cultivated together, most of the sporocarps can sprout. Sporocarps can sprout only after the megasporocarps and microsporocarps have germinated and formed male and female gametophytes.

There is no rigid restriction on the ratio of microsporocarps to megasporocarps. At maturity, and in the course of collection, *A. filiculoides* microsporocarps break. The massulae in the microsporangia attach themselves to the mature megasporocarps with glochidia. Thus, in cultivation, inoculation of additional microsporocarps is out of the question.

Temperature

A. filiculoides sporocarps can normally germinate at an average daily temperature of 20-30°C. Within this range a rise in temperature will relatively shorten the period of the germination of sporocarps.

Table 2 shows that at an average daily temperature of 32°C (ranging from 26 to 38°C), the period from sporocarp soaking to germination lasts at least 4 d and at most 26 d. Within 15-20 d, 46.5-78.7% of the sporocarps will begin to germinate. Upon germination, 80.2% of the sporocarps will turn green in 3-5 d. Of those, 66.6% will germinate in 2-3 d. It can be seen that in the course of the cultivation of sporocarp sporelings, the period from sporocarp soaking to germination is long. Sprouts will come out 5-8 d after germination.

Experiments show that at an average daily temperature of 20-30°C, the difference in the length of periods for sporocarps to germinate mainly results from the difference in the length of time required by the spores to develop into male and female gametophytes at various temperatures. Gametophytes grow slowly at low temperatures; they develop fast when the temperatures are high. At a temperature between 18 and 28.5°C, sporocarps begin to shoot about 7 d after germination.

Temperatures below 20°C are unfavorable for *A. filiculoides* sporocarps to germinate. Before germination, sporocarps can resist high temperature, but after germination they become less tolerant of heat.

Sunlight

Sunlight is a prerequisite for sporocarp germination. It is impossible for sporocarps to germinate without sunlight (Table 3).

Table 2. Germination and shooting of *A. filiculoides* sporocarps (4).

Days from sporocarp soaking to germination			Days from germination to greening			Days from greening to shooting		
Min	Max	Normal	Min	Max	Normal	Min	Max	Normal
4	26	15-20	2	7	3-5	1	4	2-3

Table 3. Effects of sunlight on the germination and shooting of *A. filiculoides* sporocarps (4).

Date of investigation	Treatment result									
	Total no. of fruit	In sunlight				In the dark				
		Germinating fruit		Shooting fruit		Germinating fruit		Shooting fruit		
	No.	%	No.	%	No.	%	No.	%		
29 Sep	200	0	0	0	0	200	0	00	0	
3 Oct	200	170	85.0	21	10.5	200	0	00	0	
10 Oct	200	170	85.0	161	81.5	200	0	00	0	

Table 4. Effect of dark treatment of *A. filiculoides* sporocarps on shooting rate (5).

Treatment	Total fruit (no.)	Shoot fruit (no.)	Shooting rate (%)
Light	521	104	20
Dark	396	179	45
Light	726	352	48
Dark	261	186	71

The rate of germination of megasporocarps rises with lengthening exposure to sunlight. During germination, megasporocarps have a constant need for sunlight, the discontinuation of which is unfavorable for sprouting. Cultivation of sporocarps in the dark for some time before they are exposed to sunlight will, to a certain extent, raise germination and sprouting rates. Sprouting rate may rise 22.9-25.2% after treatment in the dark, which shortens the time required for germination in sunlight and helps raise the sprouting rate (Table 4).

Water

The sprouting of sporocarps requires adequate water. The sexual generation of *Azolla* produces antherozoids. Only through water can the sperm enter the archegonia and unite with the eggs. Generally, there is no strict requirement for water depth. Sporocarps placed in water or just moistened can germinate. But cultivating sporocarps in water before they begin to germinate and turn green increases shooting rate by as much as 51.5%.

After germination, sporocarps are highly sensitive to water. If the sporocarps are dry, the gametophyte cannot continue growing, resulting in the failure of sporocarps to shoot. The quality of water has much to do with shooting. Experiments show, however, that redistilled water, tap water, and water from the fields make little difference in cultivation.

REFERENCES CITED

1. Shi Yan-ru and Peng Ke-li. 1980. A study of the process and shooting of *Azolla* sporocarps and the conditions of shooting [in Chinese]. Hunan Agric. Sci. Technol. 1:46-49.
2. Smith, G. M. 1959. Gryptogam. Vol. II. Science Publishing House, p. 276-283.
3. Soil and Fertilizer Institute of the Academy of Agricultural Sciences of Zhejiang Province. 1975. Cultivation, propagation, and utilization of *Azolla* [in Chinese]. Agricultural Publishing House, Beijing. p. 6.
4. Soil and Fertilizer Institute of the Academy of Agricultural Sciences of Hunan Province. 1978. Preliminary observations of the germination and shooting of *Azolla* sporocarps [in Chinese]. Changsha, China (mimeo.)
5. Soil and Fertilizer Institute of the Academy of Agricultural Sciences of Hunan Province. 1981. Nutrient elements of the seedlings of *Azolla filiculoides* and technique for large-scale cultivation of *Azolla filiculoides* sporocarps [in Chinese]. Hunan Agric. Sci. Technol. 4:22-25.

Morphogenesis of sporocarps of *Azolla microphylla*

E.G. CUTTER AND Y.R. HERD

Department of Botany

University of Manchester

Manchester M 13 9PL, United Kingdom

Material of *Azolla microphylla* (IRRI strain 418) was maintained in a N-free culture medium under controlled conditions in a growth cabinet. Developing microsporocarps and megasporocarps were fixed and embedded for observation by light microscopy, scanning electron microscopy, and transmission electron microscopy. Spore mother cells were surrounded by a tapetal layer, which became periplasmoidal. Granular material deposited in large vacuoles aggregated to form the pseudo-cells of the massulae and floats. Other electron-dense granular material from the periplasmodium contributed to wall thickening in both types of spores. Megaspores had a three-layered sporoderm, with periplasmodium occurring within the interstices of the outer layer or exoperine. The periplasmodium showed zonation in the megasporangium; the predominant organelles differed with distance from the developing megaspore. The principal components of the cytoplasm in more mature megaspores and microspores were starch-containing plastids and abundant lipids. Cells of *Anabaena azollae* were present near the apex of both types of sporocarps. Attempts to induce sporulation with added hormones were not successful.

This study examined sporocarp development in *Azolla* at light and electron microscope levels, and began to examine the factors controlling sporocarp formation. Descriptions of sporocarp development in *Azolla filiculoides* (1, 3, 6), *A. pinnata* (11), and *A. nilotica* (4) exist at the light microscope level. In addition, mature sporocarps of several species have been observed with Scanning Electron Microscopy (SEM) and Transmission Electron Microscopy (TEM) (2, 7, 12).

The origin of sporocarps has not been observed. Earlier descriptions (6, 11) attribute them to the lower lobe of the first leaf of a branch. Previous authors (1, 2, 4, 6, 11) also agree that initially, several microsporangia and a single megasporangium are initiated in each sporocarp, but in those destined to become microsporocarps the megasporangium aborts. A single megasporangium develops in the megasporocarps.

MATERIALS AND METHODS

Material of *Azolla microphylla* (No. 418 of the IRRI culture collection) was grown in a N-free liquid medium in a growth cabinet at 25°/17°C, 70% relative humidity, light intensity of 80 W/m², and a 12 h photoperiod. Sporocarps were fixed in 2.5% glutaraldehyde in 0.1 M sodium cacodylate buffer, pH 7.0, for 3 h under vacuum, postfixed in 2% osmium tetroxide, and embedded in Spurr's resin or in ultralow viscosity resin (TAAB). Infiltration extended over several days. Thin sections were stained with 2% uranyl acetate and Reynold's lead citrate.

Experimental material was maintained in the basic nutrient medium to which various hormones had been added.

RESULTS

Observations on microsporocarps

Figure 1 shows stages in microsporogenesis in *A. microphylla*. Figure 1a shows a young microsporocarp in which the central megasporangium is degenerating. The two-layered indusium encloses also several developing microsporangia and cells of the endosymbiont, *Anabaena azollae*. At a slightly later stage (Fig. 1b) sporangia in which the original apical cell and stalk cell have divided to give a central sporogenous initial and tapetum, encased in a single-layered wall, can be seen (Fig. 1b, right). The sporogenous initial divides to form 8, then 16, microspore mother cells. At this stage TEM observations show that the sporogenous cells have starch-containing plastids and that lipid deposits are present in all layers. The sporogenous cells are connected to each other and to the cells of the tapetum by numerous plasmodesmata. The spore mother cells then acquire a cell wall which resembles callose, and the tapetal cells break down to form a periplasmodium. The latter, which is electron dense and contains nuclei and other organelles, infiltrates between the microspore mother cells.

Synaptonemal complexes are visible in the nuclei of the microspore mother cells, the walls of which break down. Synchronized meiosis then takes place, giving rise to tetrads of microspores with callose-like walls. The spore tetrads contain dictyosomes, microtubules, short lengths of endoplasmic reticulum, etc., but their cytoplasm is much less electron-dense than the surrounding periplasmodium, which is also beginning to become vacuolate (Fig. 1c). The microspores develop a thick exospore, which is probably derived from granular material in the vacuoles of the periplasmodium. The periplasmodium also gives rise to three massulae composed of pseudocells and bearing glochidia (Fig. 1d). The spores become engulfed by the massulae. In *A. filiculoides* the walls of the pseudocells consist of sporopollenin (12). A more complete account of these observations has been published elsewhere (8).

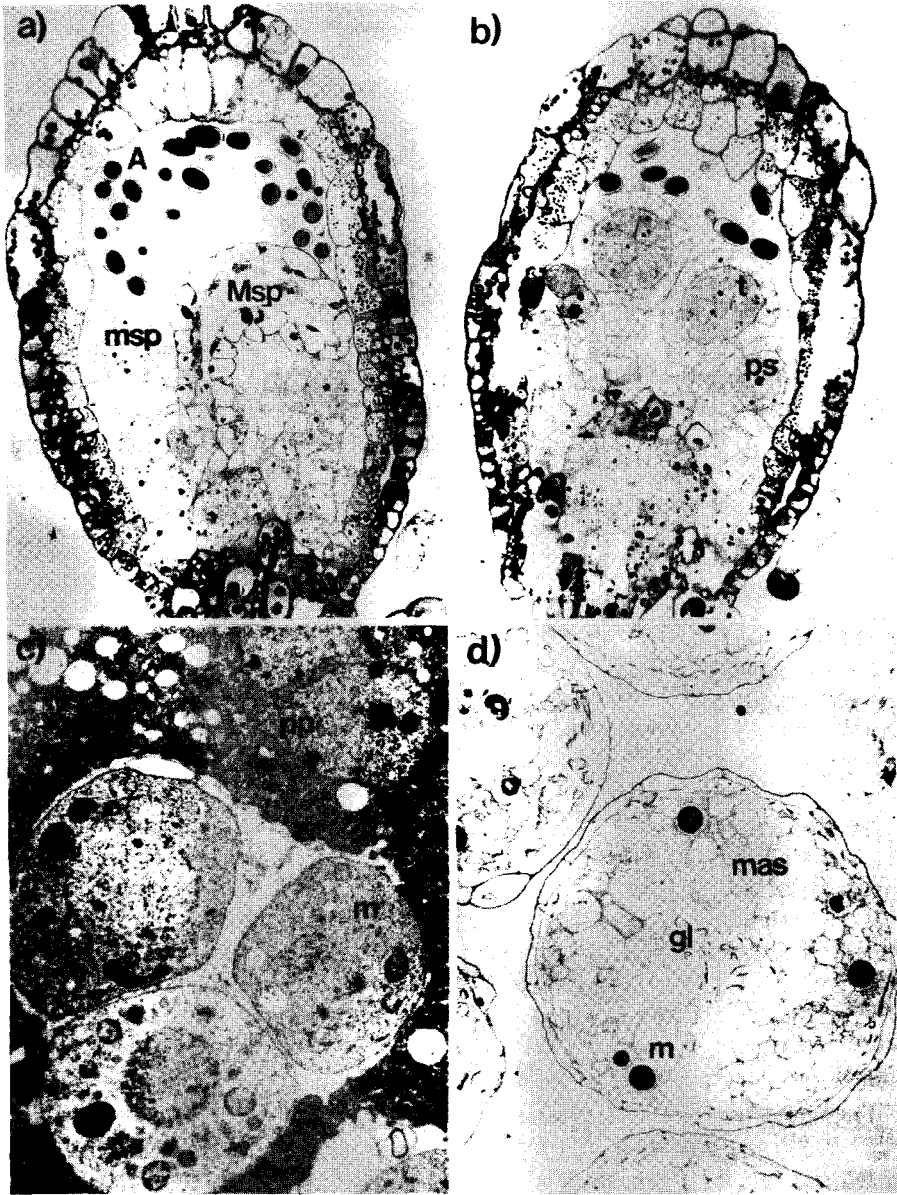

1. Stages in microsporogenesis in *Azolla microphylla*. a) L.S. Young microsporocarps in which the central megasporangium (Msp) is still present. Developing microsporangia (msp) occur on either side. Cells of *Anabaena azollae* (A) are present in the space above. b) L.S. microsporocarp with microsporangia in stages of development. ps = primary sporogenous cell, t = tapetum. c) Transmission electron micrograph of part of a microsporangium showing a tetrad of microspores (m). These have electron lucent cytoplasm compared to the surrounding periplasmodium (pp). d) T.S. microsporangium showing three pseudocellular massulae (mas) and engulfed microspores (m). Parts of glochidia (gl) are evident centrally. a, c, and d have been reproduced from Herd et al (9), with permission from the Royal Society of Edinburgh.

Observations on megasporocarps

Figure 2 shows stages in megasporogenesis in *A. microphylla*. A mature megasporocarp consists of a two-layered wall, enclosing a single megasporangium with a cavity above filled with *Anabaena* cells. Inside the wall of the megasporangium is the megaspore apparatus, consisting of a single basal megaspore with a thick wall or sporoderm, a collar, columella, and three floats. A suprafilosum consisting of filaments derived from the exoperine is present apically (Fig. 2a).

The earliest stages of megasporangium development were not observed. Eventually, all megasporos but one abort, leaving a centrally situated spore with a thin exine and peripheral cytoplasm with the usual organelles. A spiny excrescence abuts a channel in the dense tapetal periplasmodium which surrounds the megaspore (Fig. 2b). The periplasmodium is not uniform, but contains peripheral vacuoles, then a layer containing nuclei, endoplasmic reticulum associated with amyloplasts, mitochondria, lipid bodies, and polyribosomes. Immediately around the megaspore are ribosome-coated vesicles, and numerous microtubules, but no nuclei (Fig. 2b).

At a considerably later stage, the megaspore becomes crescent-shaped. A thick exine is present, and from this stage fixation of the contents was poor. Lipid and starch-containing plastids are present. In the upper parts of the megasporangium large vacuoles are evident in the sites of the future floats. Later, degenerated megasporos and granular material are deposited in these vacuoles, and distended cisternae of endoplasmic reticulum containing electron-dense material are formed around the floats. Granular material is also deposited in the space between the boundary of the periplasmodium and the exine of the spore. This material contributes to the endoperine, and the exoperine is derived from granular material in small vacuoles.

The outlines of the floats, columella, and collar gradually become distinguishable in the upper part of the sporangium (Fig. 2c), and the pseudocells of the floats form from granular material. Accumulations of membrane-bounded electron-dense material form the exoperinal filaments of the suprafilosum. Cells of *Anabaena* are evident below the indusium (Fig. 2c). Eventually the vacuole-derived material forming the pseudocells of the floats condenses to form electron-dense walls. When these walls are complete, the periplasmodium disappears. The megaspore itself is filled with reserves, including abundant lipid, and its wall consists of a thick exine, an endoperine, and a convoluted exoperine with the remains of the periplasmodium in its interstices (Fig. 2d). The development of the megasporocarp of *Azolla microphylla* is more fully described in Herd et al (9).

Experiments on sporocarp induction

Various growth substances, generally at 1.0, 10.0, and 100.0 mg/liter, added to the medium have so far failed to induce sporocarp formation. These substances include gibberellic acid, triiodobenzoic acid, ethrel, and abscisic acid. Higher concentrations of some of these substances inhibited growth.

The effects of changes in environmental conditions are being investigated.

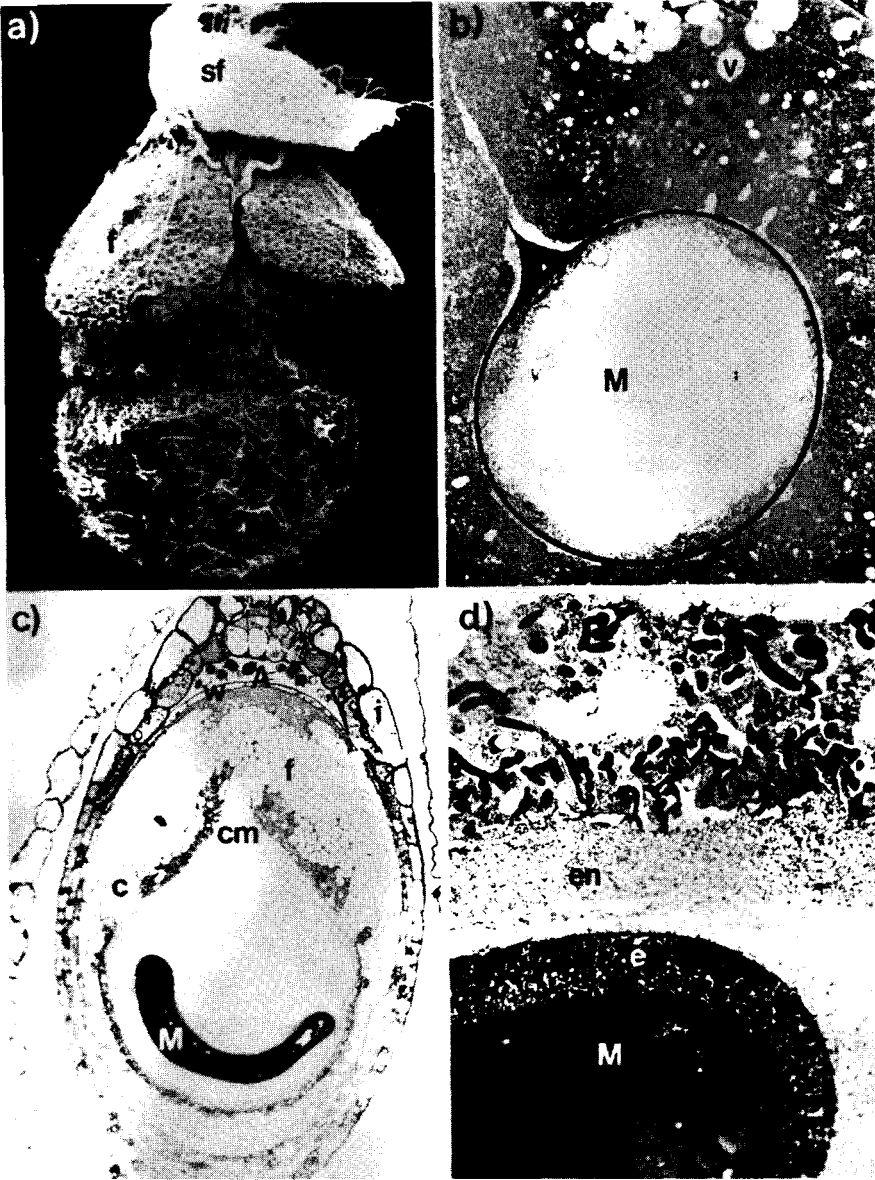

2. Stages of megasporogenesis in *A. microphylla*. a) scanning electron micrograph of mature megaspore apparatus, showing the single megaspore (M) with convoluted exoperine (ex), collar (c), three floats (f), one of which is not visible, and the suprafilosum (sf). b) transmission electron micrograph (TEM) of a young megaspore (M) surrounded by periplasmodium (pp), comprising vacuoles (v) near the periphery, nuclei, plastids and mitochondria in the middle region, and microtubules, coated vesicles, etc., in the inner region. c) L.S. megasporocarp, showing a crescentic megaspore (M), floats (f), collar (c), and columella (cm). A = *Anabaena*; i = indusium; w = wall of megasporangium. d) TEM of fairly mature megaspore (M), with poorly preserved contents, showing the wall structure, comprising the exine (e), endoperine (en), and exoperine (ex). Portions of the periplasmodium (pp) remain.

DISCUSSION

In the development of both microsporangia and megasporangia the tapetum gives rise to a periplasmodium. In the megasporangium, this is not uniform but contains different combinations of organelles with increasing distance from the megaspore. This zonation was previously noted with the light microscope (1, 11). Granular material in vesicles from the periplasmodium contributes to wall thickening in both types of spore.

Calvert et al (2) have pointed out that the massulae associated with the microspores are homologous with the floats of the megaspore apparatus. It was shown previously (12) by cytochemical methods that sporopollenin was a component both of these structures and of the spore wall, and our observations lend general support to this and suggest the source of origin. Recent experiments involving extraction of dried sporocarps of *A. mexicana* with solvents, followed by acetolysis, have indicated that sporopollenin forms 30-45% of the dry weight of the spores (14).

The presence of this extremely resistant material both in the spore wall and in components of the *capture mechanism* are clearly important in *Azolla's* ability to survive unfavorable conditions before and during sexual reproduction.

The capacity to induce sporulation at will in *Azolla* would clearly be important in the selection of improved strains for use in rice fields. To date, little success has been attained. The structural complexity of the reproductive structures, long known at the light microscope level and now further demonstrated at the ultrastructural level, may provide one reason for this. Observations that sporulation of natural populations of *Azolla* was affected by environmental conditions such as temperature and photoperiod (5, 10, 13) suggest that experimental modification of environmental conditions may be a productive line of investigation, but it seems unlikely that any simple relationship between a single factor and sporulation will be established.

ACKNOWLEDGMENT

We are indebted to the Overseas Development Administration for financial support, and to Miss J. Howard for technical assistance.

REFERENCES CITED

1. Bonnet, A. L-M. 1957. Contribution a l'etude des Hydropteridees. III. Recherches sur *Azolla filiculoides* Lam. Rev. Cytol. Biol. Veg. 18:1-86.
2. Calvert, H.E., S.K. Perkins, and G.A. Peters. 1983. Sporocarp structure in the heterosporous water fern *Azolla mexicana* Presl. Scanning Electron Microscopy 3:1433-1510.
3. Campbell, D.H. 1983. On the development of *Azolla filiculoides*, Lam. Ann. Bot. 26:155-187.
4. Demalsy, P. 1954. Le sporophyte d'*Azolla nilotica*. Cellule 56:1-60.
5. Dubyna, D.V., and V.V. Protopopova. 1983. Ecobiological features of *Azolla caroliniana* and *Azolla filiculoides*. Rastit. Resur. 19:500-506.

6. Duncan, R.E. 1940. The cytology of sporangium development in *Azolla filiculoides*. Bull. Torrey Bot. Cl. 67:391-412.
7. Fowler, K., and J. Stennett-Willson. 1978. Sporoderm architecture in modern *Azolla*. Fern Gaz. 11:405-412.
8. Herd, Y.R., E.G. Cutter, and I. Watanabe. 1985. A light and electron microscopic study of microsporogenesis in *Azolla microphylla*. Proc. R. Soc. Edinb. (in press)
9. Herd, Y.R., E.G. Cutter, and I. Watanabe. 1985. An ultrastructural study of postmeiotic development in the megasporocarp of *Azolla microphylla*. Submitted to Can. J. Bot.
10. Holst, R.W., and J.H. Yopp. 1979. Studies of the *Azolla* and *Anabaena* symbiosis using *Azolla mexicana*. I. Growth in nature and laboratory. Am. Fern J. 69:17-25.
11. Konar, R.N., and R.K. Kapoor. 1974. Embryology of *Azolla pinnata*. Phytomorphology 24:228-261.
12. Lucas, R.C., and J.G. Duckett. 1980. A cytological study of the male and female sporocarps of the heterosporous fern *Azolla filiculoides* Lam. New Phytol. 85:409-418.
13. Talley, S.N., and D.W. Rains. 1980. *Azolla filiculoides* as a fallow season green manure for rice in a temperate climate. Agron. J. 72:11-18.
14. Toia, R.E., Jr., B.H. Marsh, J.W. McDonald, and G.A. Peters. 1984. Sporopollenium content in *Azolla mexicana* spores. Plant Physiol. 75 (suppl. 1):149.

DISCUSSION

LUMPKIN: Fertile *Azolla* plants have been observed to produce different ratios of megasporocarps to microsporocarps. Could you speculate on the possible purpose or ecological advantage that this variation may impart? it would probably be an advantage to agronomists to cause the plant to produce more megasporocarps because human intervention should reduce the requirement for larger quantities of microspores.

CUTTER: The development of a sporocarp as a megasporocarp or microsporocarp must be determined at an early stage, and presumably must depend on whether the megasporangium aborts. I suspect that this depends in turn upon environmental conditions at that specific time. There may be no ecological advantage or disadvantage unless the proportion of megasporocarps falls below a certain level; but clearly it would be agronomically advantageous to be able to increase the proportion of megasporocarps. Unfortunately, we do not yet know how to do this.

LADHA: Do you consistently observe blue-green alga *Anabaena* cells in microsporocarps and megasporocarps?

CUTTER. Yes, although we believe they may degenerate in later stages of development of microsporocarps.

KANNAIYAN: At what stage of sporocarp development do the *Anabaena azolla* enter into it?

CUTTER. It is present in the earliest stage that we have observed, containing young sporangia.

Biochemical basis of *Azolla-Anabaena azollae* symbiosis

J.K. LADHA AND I. WATANABE
International Rice Research Institute
P.O. Box 933, Manila, Philippines

Important biochemical processes of *Azolla* and *Anabaena azollae* are reviewed, with special emphasis on the specificity of symbiont to host and host to symbiont. N₂ fixation occurs only in symbiont *A. azollae* cells; most of the energy is supplied by photosynthesis in host *Azolla*. Characteristically low levels of ammonium-assimilating enzymes in *A. azollae* make the N₂ fixation process very efficient. N is fixed by the symbiont and transported to the host; the host incorporates the newly fixed N into the amino acids. Probably the amino acids, along with reductant and photosynthate, then are supplied from the host to the symbiont. Because *A. azollae* is associated with *Azolla* throughout its life cycle, a free-living stage of the symbiont is not needed. Although the algal symbiont is said to have been isolated and cultured in a free-living stage, Koch's postulates have not been satisfied. Through immunofluorescence and DNA probe techniques, the symbiont *A. azollae* has been found to be similar across host species and geography. The *Azolla* leaf cavity has been shown to produce lectin; lectin may be involved in establishing or feeding the symbiotic relationship.

Worldwide, distribution of *Azolla* is represented by six recognizable species: *A. filiculoides*, *A. caroliniana*, *A. mexicana*, *A. microphylla*, *A. nilotica*, and *A. pinnata*. Their taxonomies are based primarily on vegetative and reproductive structures. All known species and strains contain the N₂-fixing blue-green alga *Anabaena azollae*.

The sporophyte of *Azolla* consists of a branched floating stem bearing leaves and true roots. The *Anabaena* symbiont occupies a specialized cavity in the aerial dorsal leaf lobes (14). The cavity also contains numerous epidermal hairs. These hair cells seem to be used to exchange metabolites between host and symbiont.

A unique feature of the *Azolla-Anabaena* symbiosis is the presence of symbiont in the host megasporocarp during its sexual cycle (Fig. 1). This continuous association between *A. azollae* and *Azolla* eliminates the need for a free-living stage of the symbiont. Although the algal symbiont is said to have

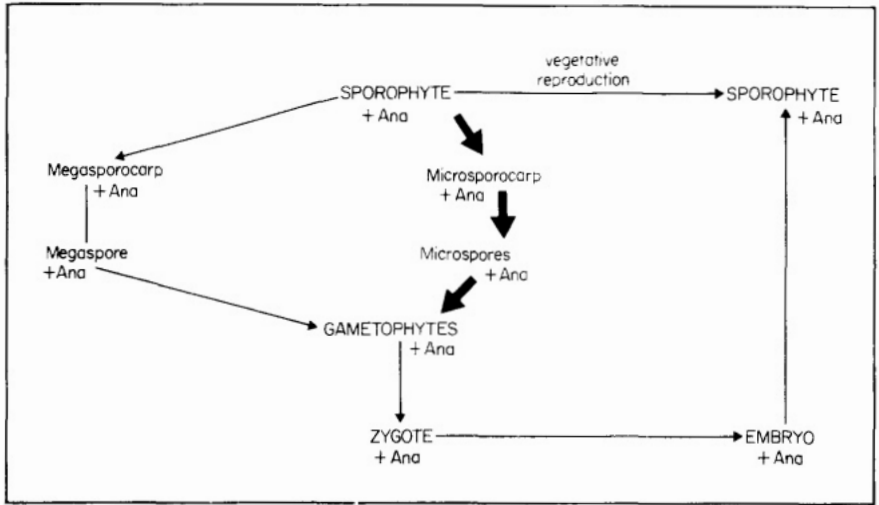
1. Life cycle of *Azolla*.

been isolated and cultured in a free-living state, Koch's postulates have not been satisfied with any of the strains isolated (15). Using immunofluorescence, Ladha and Watanabe (7) provided the first evidence that *A. azollae* freshly separated from several geographically remote specimens and species of *Azolla* show identical and highly specific antigens.

Because the blue-green algal symbiotic system with *Azolla* is important in rice cultivation, the *Azolla-Anabaena* symbiosis has attracted the attention of agronomists (24). Peters and his colleagues (16) generated a great deal of information on the physiology and biochemistry of the *Azolla-Anabaena azollae* symbiosis. But basic knowledge of the *Azolla-Anabaena azollae* symbiosis is low compared to what is known about other symbiotic systems. Many aspects of the nature of the algal symbiont and infection process are still unexplained.

In this review, we highlight important biochemical processes complementary to both parents, with special emphasis on the specificity of the symbiont to the host and of the host to the symbiont.

PHOTOSYNTHESIS, N₂ FIXATION, AND AMMONIUM ASSIMILATION

The host *Azolla* contains chlorophyll a and b and carotenoids; the symbiont *Anabaena* contains chlorophyll a, phycocyanin, allophycocyanin, and phycoerythrocyanin (22). The symbiont accounts for less than 20% of the association's chlorophyll and about 16% of the total protein. The *Azolla-Anabaena* association exhibits Calvin cycle, with phosphoglyceric acid as the initial product. Sucrose is a primary end product in *Azolla*, but not in the isolated symbiont (18).

Peters and Mayne (12) suggested that the symbiont *A. azollae* might exhibit photoheterotrophic carbon metabolism. Ray et al (18) confirmed this and suggested the existence of a transition, with increasing differentiation of the symbiont, from photoautotrophic metabolism in generative filaments to photoheterotrophic metabolism. Peters et al (16) confirmed that sucrose is synthesized only by the host, not by the symbiont, and is supplied to the symbiont.

Acetylene reduction assay and $^{15}\text{N}_2$ incorporation have shown that N_2 fixation occurs only in the symbiont *Anabaena* cells (12, 13). Photosynthesis is the ultimate source of all the adenosine triphosphate (ATP) and reductant needed for N_2 fixation. Although Photosystem II (PS II) is required to provide photosynthate for reducing power, it has been shown that it is not a principal source of ATP for N_2 fixation. The primary source of ATP for N_2 fixation in light is Photosystem I (PS I). These results, and other studies, suggest a strong interaction between photosynthesis and N_2 fixation (23).

A. azollae has two kinds of cells: vegetative cells and heterocyst. The heterocyst is the actual site of N_2 fixation. A remarkable feature of symbiotic *A. azollae* is very high heterocyst frequency: the distance between 2 heterocysts is about 3-5 vegetative cells. In free-living blue-green algae, that distance is 15-30 vegetative cells (Fig. 2.1). The high heterocyst frequency in symbiont *A. azollae* could be explained by its characteristically low levels of ammonium-assimilating enzymes.

Diagrammatic representations of heterocysts and vegetative cells illustrate the different nitrogen metabolism enzymes (Fig. 3). The enzyme nitrogenase is present in heterocyst. Energy for N_2 fixation is supplied by PS I or cyclic photophosphorylation; the reductant comes from the oxidative pentose phosphate pathway. The newly fixed N is incorporated into glutamine via glutamine synthetase (GS) present in the heterocyst. The enzyme glutamate synthase (GOGAT) has been found to be active only in the vegetative cell, so glutamate is supplied from the vegetative cell to the heterocyst.

A unique feature of heterocysts is that they cannot fix carbon and do not have PS II. Because nitrogenase is highly oxygen sensitive, the heterocyst cannot afford to have PS II. Thus, the heterocyst fixes N, which is transported to a nearby vegetative cell. The Vegetative cell, in turn, fixes carbon and transports it to the heterocyst. This is a good example of symbiosis at the cellular level.

The heterocyst formation is believed to be regulated by newly fixed N or its product (5, 21). Studies of ammonia-assimilating enzymes in the *Azolla-Anabaena* symbiosis and the *Anabaena* symbiont showed that, although both partners had GS, GOGAT, and glutamic dehydrogenase (GDH) activity, the host was estimated to account for at least 90% of the association's GS activities and 80% of the total GDH (17).

The specific GS activities of symbiont *A. azollae* were half those obtained with free-living blue-green algae. Orr and Haselkorn used antiserum to GS

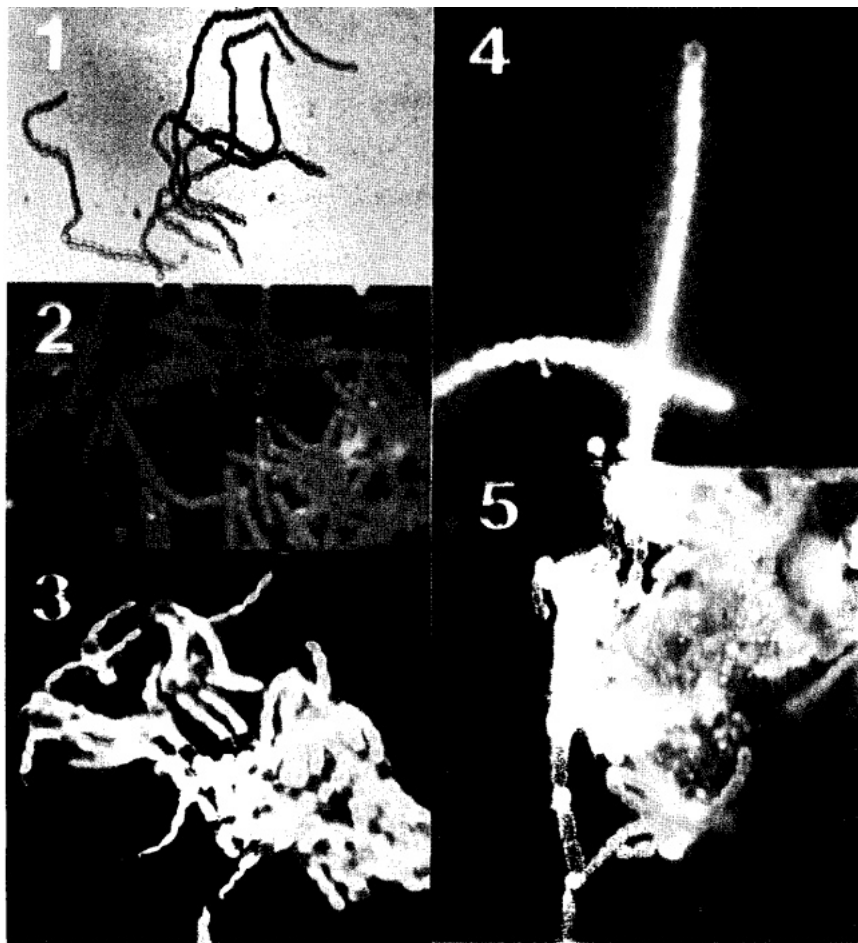

2. Photomicrographs of 1) symbiotic *Anabaena azollae* cells under normal microscope; 2) under fluorescence microscope (red color is due to autofluorescence of chlorophyll); 3) fresh cells stained with homologous FA showing typical yellow-green fluorescence of the fluorescein isothiocyanate; 4) Newton's culture stained with homologous FA; and 5) symbiotic *A. azollae* cells along with *Azolla* plant debris stained with Newton's *Anabaena* FA. Symbiotic *A. azollae* did not show any staining while the *Azolla* debris showed nonspecific staining.

from free-living *Anabaena* 7120 (11). They reported that the symbiont *A. azollae* exhibited only 5% of the GS protein exhibited by free-living *Anabaena azollae* (Newton). Peters et al (16) analyzed hair cells and symbiont of the leaf cavity of *Azolla* (Table 1) and confirmed the low GS activity associated with *A. azollae*. However, the GDH activity previously attributed to the symbiont resulted from the incomplete removal of cavity hairs.

It would be interesting to find out why the symbiont showed half the specific GS activity of free-living blue-green algae, despite the presence of only 5-10% of the GS protein. The enzymatic studies of *Azolla* symbiosis were

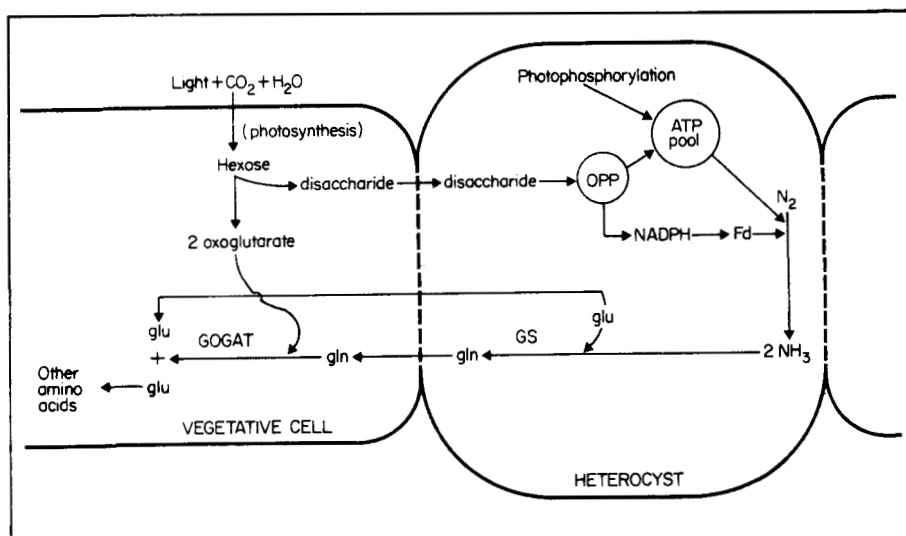

3. N_2 fixation and NH_3 assimilation pathways in vegetative cell and heterocyst.

Table 1. Specific activity of ammonia-assimilating enzymes in extracts of the *Azolla-Anabaena* association. *Anabaena* with and without cavity hairs, and two hair types (15).

Enzyme	Glutamine synthetase ^a		GDH ^b
	Biosynthetic activity	Transferase activity	
Association	44 ± 1	921 ± 10	31 ± 4
Anabaena with cavity hairs	14 ± 3	192 ± 11	48 ± 15
Anabaena	10 ± 1	170 ± 39	2 ± 5
Simple hairs	28 ± 7	106 ± 41	469 ± 80
Branched hairs	N.D.	N.D.	397 ± 67

^anmoles γ -glutamylhydroxamate formed/mg protein per min. ^bnmoles NADH oxidized/mg protein per min. N.D. = not detectable, GDH = glutamic dehydrogenase, NADH = nicotinamide adenine dinucleotide.

made on individual partners after they were physically separated. The levels of ammonium-assimilating enzymes actually active in the symbiont and host in vivo are not known. The possibility that the physical separation of symbiont from host does not activate detectable GS/GOGAT and GDH enzymes cannot be ruled out.

The occurrence of low level and low activity GS protein in the symbiont could be important in explaining high heterocyst frequency and N_2 -fixing activity. When GS in free-living N_2 -fixing blue-green algae is inhibited by metabolic inhibitors such as L-methionine-DL-sulfoximine (MSO) (19), or 5-hydroxylysine (HL) (6), the alga continues to produce heterocysts and fix N

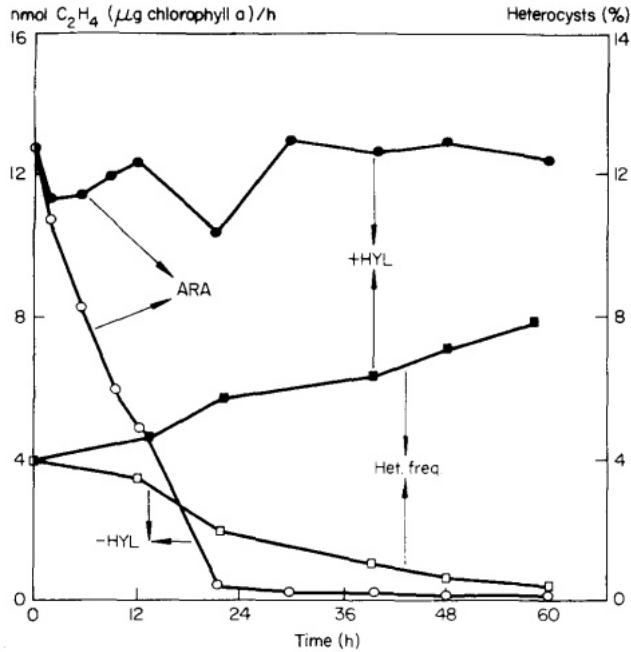

4. Effect of HYL on nitrogenase activity and heterocyst formation in *A. cylindrica* (6).

in the presence of NH_4^+ , probably until the endogenous reserve of reductant, photosynthate, and amino acids is exhausted (Fig. 4).

A similar mechanism seems to be operating in *Azolla-Anabaena* symbiosis, where N is fixed by the symbiont, then transported to the host. The host *Azolla* incorporates this newly fixed N into amino acids. Probably these amino acids, along with reductant and photosynthate, are then supplied to the symbiont (Fig. 5). How far the symbiont depends on host for its amino acid requirement in vivo is not known.

ANTIGENIC CHARACTERISTICS AND LECTIN PRESENCE IN *ANABAENA AZOLLAE*—*AZOLLA* ASSOCIATION

Until recently, whether the symbiont *A. azollae* was similar or different in species and strains of *Azolla* was not known (15). The main problem in resolving this question was the inability to grow the symbiont in a free-living state, without the host. Although a few reports claimed isolation and culture of *A. azollae* free from host, the claims were not supported with appropriate evidence.

Ladha and Watanabe (7) used an immunofluorescence technique to study the problem. Several antisera and fluorescent antibodies (FAs) were prepared against symbiotic *A. azollae* (Fig. 2) freshly separated from different species of *Azolla*, free-living *Anabaena* sp., and *Anabaena*-free *Azolla* (Table 2).

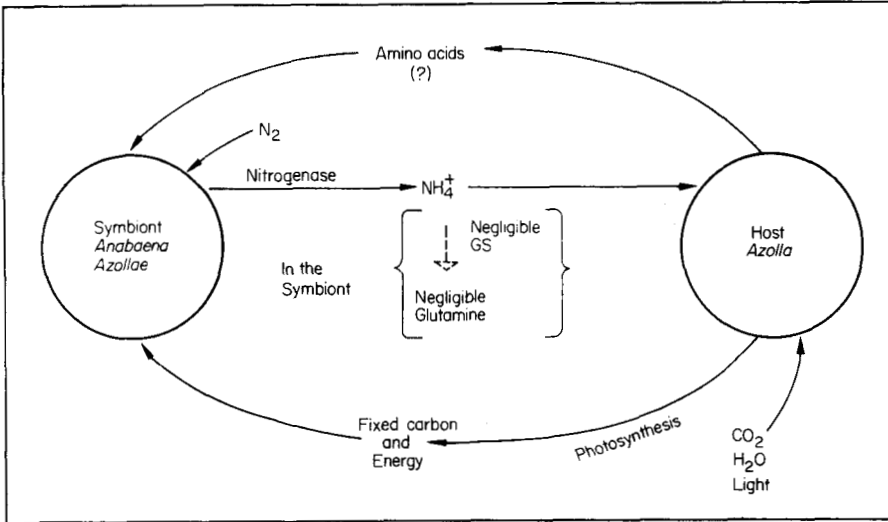

5. Exchange of metabolites between host and symbiont in *Azolla*.

Table 2. Antisera of fluorescent antibodies prepared against symbiotic and free-living *Anabaena* and *Anabaena*-free *Azolla* and their source.

Sample	Species	Accession no. and source
<i>Symbiotic A. azollae separated from</i>		
1	<i>A. pinnata</i>	22, Tancheng, China
2	<i>A. pinnata</i>	39, MIA, Australia
3	<i>A. filiculoides</i>	106, Hamburg, Germany
4	<i>A. caroliniana</i>	301, Ohio, USA
5	<i>A. microphylla</i>	412, Paraguay
<i>Free-living Anabaena species</i>		
6	<i>A. azollae</i>	Newton (USA)
7	<i>A. azollae</i>	Bai Ke-zhi (China)
8	<i>A. flos-aquae</i>	ATCC 22664
9	<i>Anabaena</i> -free <i>Azolla pinnata</i>	22, Tancheng, China

Immunofluorescence reactions of the FAs against several symbiotic and free-living blue-green algae are shown in Table 3.

Cells of *A. azollae* showed red autofluorescence of the chlorophyll when they were observed unstained under the fluorescent microscope (Fig. 2.2). However, specifically stained vegetative cells fluoresced with the typical yellow-green of fluorescein isothiocyanate (FITC). Heterocysts appeared completely red, indicating that the antibody was produced mostly against vegetative cells (Fig. 2.3, 2.4). All FAs against symbiotic *A. azollae* strongly cross-reacted with symbiotic *Anabaena* of all species and specimens of *Azolla* tested, but not with any of the free-living blue-green algae. This clearly indicates that the symbiotic *Anabaena* from all species of *Azolla* share identical and highly specific antigens.

Table 3. FA reaction of *Anabaena azollae* against selected symbiotic and free-living blue-green algae (7).

Antigen (accession no.)	FA reaction of accessions and FA ^a						
	22	39	106	301	412	Newton	BaiKe-zhi
Symbiotic <i>A. azollae</i> ^b separated from							
<i>A. pinnata</i> (22)	4+	4+	3+	4+	4+	—	—
<i>A. pinnata</i> (39)	3+	4+	3+	4+	3+	1+	—
<i>A. filiculoides</i> (106)	3+	3+	4+	3+	3+	1+	—
<i>A. caroliniana</i> (301)	3+	3+	3+	4+	3+	1+	—
<i>A. microphylla</i> (412)	4+	3+	3+	3+	4+	1+	—
Symbiotic <i>Nostoc</i> sp. separated from the coralloid root of 5 species of <i>Cycas</i>							
Free-living blue-green algae ^c							
<i>A. azollae</i> (Newton)	—	—	—	—	—	4+	—
<i>A. azollae</i> (Bai Ke-zhi)	—	—	—	—	—	—	4+
<i>A. flos-aquae</i> (ATCC 22664)	—	—	—	—	—	4+	—

^a A dash (-) indicates no detectable fluorescence. 1+ to 4+ indicate minimum to maximum fluorescence. Underscoring indicates a homologous reaction. ^b Symbiotic *A. azollae* separated from following species and strains of *Azolla* showed 3+ to 4+ fluorescence against FAs of Nos. 22, 39, 106, 301, and 412 and no reaction against FAs of Newton and Bai: *Azolla pinnata* from Philippines (accession nos. 1, 15, 24, 36), Malaysia (2), Indonesia (3), Thailand (5, 6), Bangladesh (11), Nepal (13), Vietnam (17), China (29), India (23, 44), and Ivory Coast (25); *A. filiculoides* from E. Germany (101), USA (107,108); *A. mexicana* from USA (201) and Guyana (20); *A. caroliniana* from Uruguay (304); *A. microphylla* from Paraguay (401,408); and *A. nilotica* from Sudan (501). ^c These species and strains of free-living blue-green algae showed no fluorescence against all FAs: *A. subcylindrica* (CCAP 1403/4b Netherlands), *A. variabilis* and *A. Rorulosa* (India), *A. cylindrica* (China), *Anabaena* sp. (PCC 7120 and PCC 7122, France), *Anabaena* sp. (CA, USA), *Nostoc* sp. (PCC 73102, France), *Nostoc* sp. (Sri Lanka), *Gloeotrichia* sp. (Philippines), and *Oscillatoria* sp. (PCC 7515, France).

Franche (1) used DNA probes to reach similar conclusions. He found that, regardless of the geographical origin of *Azolla*, the size of the *A. azollae* DNA fragments which hybridized to the *Anabaena* sp. PCC7120 *nif K* and *nif D* genes was identical in each symbiotic *Anabaena*.

The FA against free-living *A. Azollae* that Newton and Bai claimed to have isolated did not cross-react with any of the symbiotic *A. Azollae* (Fig. 2.5) or free-living blue-green algae tested except *A. flos-aquae* (ATCC 22664). *A. flos-aquae* strongly cross-reacted with Newton FA at a similar antibody dilution. The close identity of these two strains was further confirmed by absorption of Newton FA. Gates et al (3) reported similar results. They speculated that during isolation and culturing, the symbiotic *A. Azollae* either changed its morphology and surface antigenicity or mutated.

It seems unlikely that highly specific antigens of symbiotic *A. Azollae* would change to such an extent that they would become identical to those of the already existing free-living species *A. flos-aquae*. Considering the results obtained by Ladha and Watanabe (7, 8), Gates et al (3) suspected that the strain isolated by Newton is probably not a true isolate of *A. azollae*. This could be clarified by reintroducing this isolate into *Anabaena-free Azolla*

Table 4. FA reactivity of *Anabaena*-free *Azolla pinnata* antiserum (8).

Antigen (accession no.)	FA reactivity against <i>Anabaena</i> -free <i>Azolla</i> antiserum ^a
Fronds of <i>Anabaena</i> -free <i>Azolla pinnata</i> 22	4+
Symbiotic <i>A. azollae</i> separated from	
<i>A. pinnata</i> 22	2+
<i>A. pinnata</i> 39	2+
<i>A. pinnata</i> 44	2+
<i>A. filiculoides</i> 106	2+
<i>A. caroliniana</i> (301)	2+
Free-living <i>Anabaena</i> sp.	
<i>A. azollae</i> (Newton)	-
<i>A. flos-aquae</i> ATCC 22664	-
<i>A. torulosa</i>	-
<i>A. variabilis</i>	-

^a A dash (-) indicates no detectable fluorescence. 1+ to 4+ indicate minimum to maximum fluorescence. Underscoring indicates a homologous reaction.

plants. The sporocarp of *Azolla* could be a site for reintroducing the free-living blue-green algae. Unfortunately, *Anabaena*-free *Azolla* plants do not produce sporocarps (unpubl.).

Ladha and Watanabe (7) found that FA reactivity with symbiotic *A. azollae* was reduced when FA against *Anabaena azollae* was absorbed with crude leaf extract suspension of *Anabaena*-free *Azolla*. This indicates the possibility that cross-reactive antigens exist between *Azolla* leaves and the surfaces of *A. azollae*. This was further confirmed using indirect FA against *Anabaena*-free *Azolla*. FA reactions of *Anabaena*-free *Azolla* antiserum against symbiotic *A. azollae* showed 2+ fluorescence; none of the free-living *Anabaena* sp., including *A. azollae* (Newton), showed any cross-reaction (Table 4).

Cross-reactive antigens identified as polysaccharide have been reported between legumes and *Rhizobium* symbiosis (2). A successful symbiosis probably requires an interaction between these cross-reactive antigens and the lectins of the legumes.

Mellor et al (9) reported the presence of lectin in *Azolla-Anabaena* symbiosis. They found that extracts of whole *A. caroliniana* and of *Anabaena*-free *Azolla* plants caused agglutination of human erythrocytes; extracts of symbiotic *A. azollae* freshly separated from the *A. caroliniana* plants or free-living *A. azollae* (Newton) did not. In contrast, Kobilier (4) reported haemagglutination activity in extracts of free-living *A. azollae* but very low activity in extracts of *A. filiculoides*.

Using *Azolla* plants completely free from *Anabaena* cells, Ladha and Watanabe (8) found a higher haemagglutination activity in extracts from whole *Azolla-Anabaena* symbiosis than from *Anabaena*-free *Azolla* and absolutely no activity in symbiotic or free-living *A. azollae*. This clearly shows that the presence of lectin in the *Azolla-Anabaena* symbiosis was due only to its occurrence in the host *Azolla*, not to its occurrence in algal cells. Mellor et al

(10) further showed that the major locus of the lectin produced by the *Azolla-Anabaena* symbiosis is around the *Anabaena*.

To establish eukaryotic plant and blue-green algal symbiosis, the host plant must be infected with a specific blue-green algal symbiont. In most symbiotic systems (including the legume-*Rhizobium* symbiosis), the association of the symbiont with its host is not maintained throughout the host's life cycle (20). The association between *Azolla* and *Anabaena* is the only relationship known in which the association between symbiont and host continues during the sporophyte and gametophyte cycles. Also, it has not been possible to isolate and culture the *Anabaena* symbiont free from its *Azolla* host.

These facts would seem to rule out the need for the host to be infected by free-living *Anabaena*. It also suggests that such a host-specific algal symbiont is likely to exist in the free-living state.

What is the role of lectin in *Azolla-Anabaena* symbiosis? Mellor et al (10) suggested that lectin might be involved in establishing or feeding the partnership. More work is required on characterizing the reactivity of host cell-originated antigen, symbiont antigen, and lectin to explain their roles in the *Azolla-Anabaena* symbiosis.

REFERENCES CITED

1. Franche, C. 1984. The structural *nif* genes of four symbiotic *Anabaena azolla* show a high conserved physical arrangement. Paper presented at the Third International Symposium on N₂ Fixation with Nonlegumes, held at 2-8 Sep, Helsinki. p. 92.
2. Dazzo, F.B., and D.H. Hubell. 1975. Cross-reactive antigens and lectin as determinants of symbiotic specificity in the *rhizobium*-clover associated. Appl. Microbiol. 30:1017-1033.
3. Gates, J.E., R.W. Fisher, T.W. Goggin, and N.I. Azrolan. 1980. Antigenic differences between *Anabaena azollae* fresh from the *Azolla* fern leaf cavity and free-living cyanobacteria. Arch. Microbiol. 128:126-129.
4. Kobiler, D., A. Cohen-Sharon, and E. Tel-Or. 1984. Recognition between the N₂-fixing *Anabaena* and the water fern *Azolla*. Fed. Eur. Biochem. Soc. Letters 133:157-160.
5. Ladha, J.K., and H.D. Kumar. 1978. Genetics of blue-green algae. Biol. Rev. 53:355-386.
6. Ladha, J.K., P. Rowell, and W.D.P. Stewart. 1978. Effects of 5-hydroxylysine on acetylene reduction and NH₄⁺ assimilation in the cyanobacterium *Anabaena-cylindrica*. Biochem. Biophys. Res. Commun. 83:688-696.
7. Ladha, J.K., and I. Watanabe. 1982. Antigenic similarity among *Anabaena azollae* separated from different species of *Azolla*. Biochem. Biophys. Res. Commun. 109:675-682.
8. Ladha, J.K., and I. Watanabe. 1984. Antigenic analysis of *Anabaena azollae* and the role of lectin in the *Azolla-Anabaena* symbiosis. New Phytol. 98:295-300.
9. Mellor, R.B., G.M. Gadd, P. Rowell, and W.D.P. Stewart. 1981. A phytohaemagglutinin from the *Azolla-Anabaena* symbiosis. Biochem. Biophys. Res. Commun. 99:1348-1353.
10. Mellor, R.B., P. Rowell, and W.D.P. Stewart. 1982. The non-random distribution of lectin in the *Azolla caroliniana-Anabaena azollae* symbiosis. Pages 106- 112 in Lectins - Biol. Biochem, Clinical Biochem, Vol II. Walter de Gruyter & Co., Berlin, New York.
11. Orr, J., and R. Haselkorn. 1982. Regulation of glutamine synthetase activity and synthesis in free-living and symbiotic *Anabaena* sp. J. Bacteriol. 152:626-635.
12. Peters, G.A., and B.C. Mayne. 1974. The *Azolla-Anabaena azollae* relationship. II. Localization of nitrogenase activity as assayed by acetylene reduction. Plant Physiol. 53:820.

13. Peters, G.A., R.E. Toia, Jr., and S.M. Lough. 1977. *Azolla-Anabaena azollae* relationships. V. $^{15}\text{N}_2$ fixation, acetylene reduction and H_2 production. *Plant Physiol.* 59:1021-1025.
14. Peters, G.A., R.E. Toia, Jr., D. Raveed, and N.J. Levine. 1978. The *Azolla-Anabaena* symbiosis: morphology, physiology and use. *Israel J. Bot.* 31:305-323.
15. Peters, G.A., H.E. Calvert, D. Kaplan, O. Ito, and R.E. Toia, Jr. 1982. The *Azolla-Anabaena* symbiosis: morphology, physiology and use. *Israel J. Bot.* 31:305-323.
16. Peters, G.A., D. Kaplan, J.C. Meeks, K.M. Buzby, B.H. Marsh, and J.L. Corbin. 1985. Aspects of nitrogen and carbon interchange in the *Azolla-Anabaena* symbiosis. Pages 212-222 in *Nitrogen fixation and CO_2 metabolism*. P.W. Ludden and J.E. Burris, eds. Elsevier Science Publishing Co., Inc.
17. Ray, T.B., G.A. Peters, R.E. Toia, Jr., and B.C. Mayne. 1978. The *Azolla-Anabaena azollae* relationship. VII. Distribution of ammonia assimilating enzymes, protein and chlorophyll between host and symbiont. *Plant Physiol.* 62:463-467.
18. Ray, T.B., B.C. Mayne, R.E. Toia, Jr., and G.A. Peters. 1979. The *Azolla-Anabaena azollae* relationship. VIII. Photosynthetic characterization of the association and individual partners. *Plant Physiol.* 64:791.
19. Stewart, W.D.P., and P. Rowell. 1975. Effects of L-methionine DL-sulphoximine on the assimilation of newly fixed NH_3 , acetylene reduction and heterocyst production in *Anabaena cylindrica*. *Biochem. Biophys. Res. Commun.* 65:846-856.
20. Stewart, W.D.P., P. Rowell, and C.M. Lockhart. 1979. Associations of nitrogen-fixing prokaryotes with higher and lower plants. Pages 45-66 in *Nitrogen-assimilation of plants*. E. J. Hewitt and C.V. Cutting, eds. Academic Press, London.
21. Stewart, W.D.P., P. Rowell, J.K. Ladha, and M. J.A.M. Sampaio. 1979. Blue-green algae (Cynobacteria) - some aspects related to their role as sources of fixed nitrogen in paddy soils. Pages 263-285 in *Nitrogen and rice*. International Rice Research Institute, P.O. Box 933, Manila, Philippines.
22. Tyagi, V.V.S., B.C. Mayne, and G.A. Peters. 1980. Purification and initial characterization of phycobiliproteins from the endophytic cyanobacterium of *Azolla*. *Arch. Microbiol.* 128:41-44.
23. Tyagi, V.V.S., T.B. Ray, B.C. Mayne, and G.A. Peters. 1981. The *Azolla-Anabaena azollae* relationship. XI. Phycobiliproteins in the action spectrum for nitrogenase-catalyzed acetylene reduction. *Plant Physiol.* 68:1470-1484.
24. Watanabe, I. 1984. Use of symbiotic and free-living blue-green algae in rice culture. *Outlook Agric.* 13:166-172.

DISCUSSION

KULASOORIYA: Do you know whether the endosymbiotic cavity of the *Azolla* is aerobic or microaerobic? Do you know if vegetative cells of *Anabaena azollae* also fix any N_2 inside the *Azolla* plants and whether N_2 fixation takes place exclusively in the heterocysts?

LADHA: I do not know if any information is available on this aspect but I would think that there is aerobic condition in the cavity. Again, I do not know if there is any published work available to answer your question. However, the presence of a very high heterocyst frequency in symbiotic *A. azollae* would rule out such a possibility. If we think that vegetative cells might also be fixing nitrogen because of microaerobic condition from the generative *Anabaena filaments* in the leaf, then apical colonies which lack heterocysts should also fix nitrogen. But this is not the case.

KANNAIYAN: What is the role of lectin in *Azolla-Anabaena* symbiosis, since *Anabaena* does not infect the cells of *Azolla*?

LADHA: At present we do not know the exact role of lectin in *Azolla-Anabaena azollae* symbiosis.

LUMPKIN: How have you verified that *Azolla* provides glutamate and glutamine to the *Anabaena*? How did you remove or transfer hairs from the *Anabaena* colonies which were used in the immunological technique?

LADHA: I have not verified this, but it could be glutamine, glutamate, and/or other amino acids. At present it is not clear whether amino acids are transported from *Azolla* to *Anabaena* and, *if so*, which amino acids are transported. *A. azollae* cells were separated by the roller method of Peters and Mayne. We did not remove hair cells. There was *Azolla* plant debris with the *Anabaena* preparation, but the amount was very small compared to the *Anabaena* fraction. Anyway, the antibody prepared that way was purified by adsorbing with *Anabaena*-free *Azolla*.

LI HI-RU: Does the algal *Anabaena* get into the cavity of *Azolla* leaves from irrigation, water or does it harbor inside the spore before the *Azolla* plant develops?

LADHA: We do not know if *Anabaena* cells can enter the *Azolla* leaf-cavity from outside. That is unlikely, because *Anabaena* cells are present throughout the growth cycle of *Azolla*.

Some physiological properties of akinetes of *Anabaena azollae*

BAI KE-ZHI, WU GUOLIANG,
AND CHENG CUI (C.TSUI)
Institute of Botany
Academia Sinica
Beijing, China

Results of studies on the physiological properties of the akinetes of *Anabaena azollae* to probe the mechanism of synchronized development are summarized. Simple methods for akinete isolation and preservation were developed focusing on the mechanism of their light-dependent germination. Two maxima occurred in the spectra, one at 385 nm and the other at 615 nm. The action of photosynthate on germination processes is confirmed. The photoreceptor absorbing at 385 nm was identified as NaN_3 -sensitive, and that at 615 nm as phytochrome or its analogues. A model for the mode of action of light in the germination of akinetes is suggested.

In the sexual reproductive cycles of *Azolla* during which the microsporocarps and megasporocarps are formed, akinetes of the symbiont *Anabaena azollae* also formed and were incorporated into the sporocarps. Under ideal conditions, spores of the fern and akinetes of the alga will germinate synchronously to form new symbiotic bodies. Almost nothing is known about how the fern and the alga coordinate their development in nature. As a preliminary attempt at explanation, this paper deals with akinete isolation, preservation, and germination processes using free-living *A. azollae* that were isolated in our laboratory (1) as test materials.

In N-free BG-11 medium, the akinete-rich cultures were obtained by inoculating the routine culture to *standard sporulation medium* (9) and incubating in dim light 6-8 wk. The akinete-rich culture of *A. azollae* was harvested by centrifuging the culture at 1,000 g. The collected algal slurry was pretreated with a glass homogenizer and then mixed 10 times with 0.2% (v/v) digitonin, and incubated at room temperature for 24 h. After all the vegetative cells of the filaments were digested, the mixture was again centrifuged at 1,000 g and the supernatant was discarded. The akinetes were washed three times with distilled water and then transferred to the BG-11 medium with adequate akinete concentration and refrigerated.

By adding a drop of akinete suspension onto an agarose plate and incubating it under adequate light to 24-84 h, more than 90% akinetes germinated, a rate equal to or slightly higher than the germination rate of intact akinetes.

This method has also been used satisfactorily for *A. cylindrica* and *A. variabilis*.

The akinete isolation method described here is simple and safe for the akinetes. In an experiment, akinetes germinated normally even after treatment with digitonin for 72 h (3). With some modification, the method can be used to isolate proheterocysts and heterocysts that exhibit N-fixing activity (5).

The akinetes immersed in BG-11 N-free medium were placed into a stainless steel vessel without cryoprotectants and immersed in liquid N for 8 wk. At the end of the period, the akinetes were thawed in a 30 °C water bath for 5 min and inoculated on the surface of a 1.5% agarose medium for germination. About half of the akinetes germinated normally, indicating that cryopreservation is a potentially simple and labor- and space-saving method for long-term preservation of blue-green algae (2).

It has been reported that akinete germination of some species of blue-green algae is light-dependent (6). It was confirmed in *A. azollae* in our experiments. The influence of light intensities on the germination of *A. azollae* akinetes shows that 25,000 erg/cm² per s had an excellent effect in the 32 h continuous light regime within the range of 1,000-100,000 erg/cm² per s.

A group of interference filters with half-band width 2.5-4 nm and transmittances of 40-60% were used to obtain monochromatic light to observe

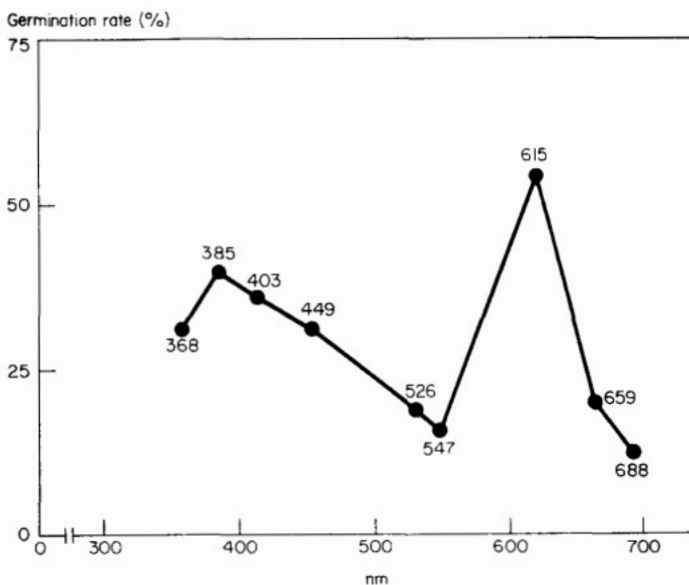

1. Effect of wavelength on the germination of akinetes of *A. azollae*.

the effects of light of different wavelengths under uniform light flux rate (2,000 erg/cm² per s) on the germination of akinetes. Figure 1 shows that the effects of 615 nm and 385 nm light irradiations are much stronger.

To ascertain whether the pigment absorbing at 615 nm is reversible, the red/far-red reversibility experiment was carried out. It shows the typical phytochrome reaction (Table 1), although the red light absorbing maxima shifted from 660 to 615 nm.

According to Mohr (7), the crucial test for the existence of functional phytochrome is dichromatic irradiation. The results of simultaneous irradiation with red/far-red and blue-UV/far-red light show that the morphogenetic effect of red light is clearly abolished by far-red light (Fig. 2). This result confirms that the photoreceptor absorbing at 615 nm is phytochrome or its analogues and that at 385 nm it is a pigment different from phytochrome. The 385 nm absorbing pigment proved to be NaN₃-sensitive (4).

It is not surprising to find the blue-UV photoreceptor in the akinetes of blue-green algae, although it has not been described in the literature, because this photoreceptor is detectable in different plants and acts as a sensor pigment in a number of responses.

Table 1. Effect of the reversible red (R) far-red (FR) control on the germination of akinetes of *Anabaena azollae*.^a

Treatment	Germination rate (%)
48 h dark (control)	0
24 h R	17.6
24 h R, 3.5 h FR	8.8
24 h R, 3.5 h FR, 3 h R	17.8
24 h R, 3.5 h FR, 3 h R, 3.5 h FR	7.2
24 h R, 3.5 h FR, 3 h R, 3.5 h FR, 3 h R	18.7

^aR = 615 nm, 600 erg/cm² per s; FR = 743 nm, 5,500 erg/cm² per s.

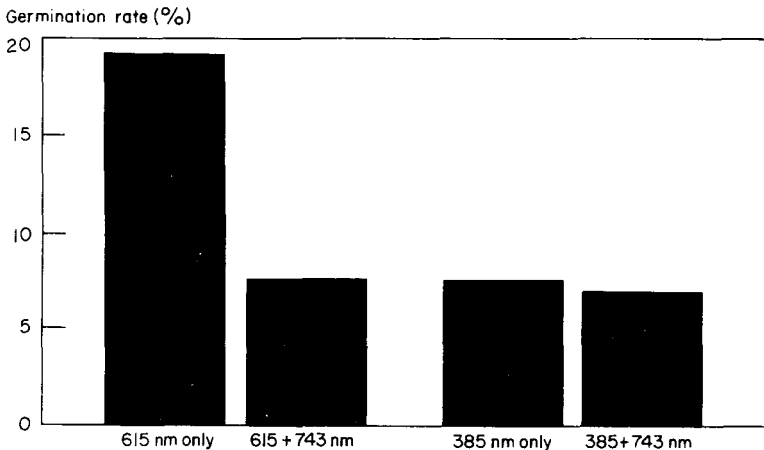

2. Effect of dichromatic irradiation on the germination of akinetes of *A. azollae*.

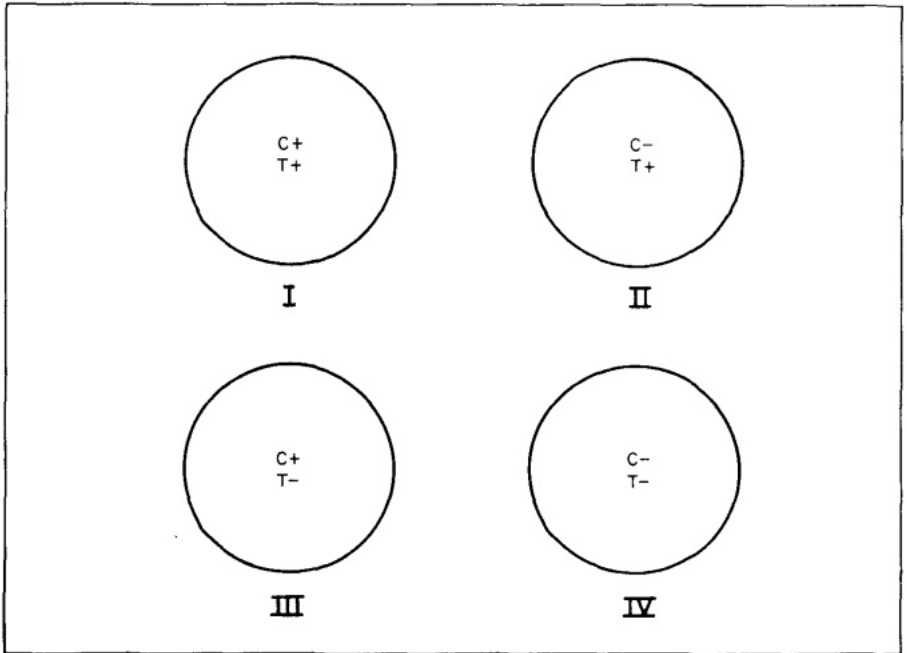

3. A hypothetical model of akinete population consisting of four subpopulations according to the situation of carbohydrate storage (C) and light trigger action (T)

The action of photosynthate on germination is demonstrated by the CO_2 released to the atmosphere in the germination process (4).

The results reported here confirm that both the photosynthetic activity, which supplies energy for akinete germination, and the triggering action of red and blue-UV light are involved in germination. A hypothetical model (Fig. 3) to represent the relation between the two factors in an akinete population is proposed. It is supposed that any population of akinetes is a mixture of four subpopulations differing in photosynthate storage (C) and trigger action (T). Different populations would show different light-dependent reactions because the ratio of their four subpopulations varies. For instance, the akinetes of subpopulation III (Fig. 3) could germinate under blue-UV light, while the akinetes of subpopulation IV must be irradiated by red or white light to provide the carbohydrate supply and to elicit a triggering action. Using this model, all of the conflicting results so far reported (6) can be explained satisfactorily.

REFERENCES CITED

1. Bai Ke-zhi, Yu Sailing, Chen Weilun, and Yang Shangying. 1978. Cultivation of alga-free *Azolla*, isolation of *Anabaena azollae* and preliminary attempt at their association. Pages 455-457 in Proceedings, symposium on plant tissue culture. Science Press, Beijing, China.
2. Bai Ke-zhi and Cui Cheng. 1983. Cryopreservation of the akinetes of blue-green alga *Anabaena azollae*. Kexue Tonbao 28:288.
3. Bai Ke-zhi, Wu Guoliang, and Cui Cheng. 1981. A simplified method for akinete isolation in blue-green algae and preliminary observation on the light-dependent germination of akinetes of *Anabaena azollae*. Pages 401-408 in Proceedings of the joint China-U.S. phycology symposium. Science Press, Beijing, China.
4. Bai Ke-zhi, Wu Guoliang, and Cui Cheng. 1983. Studies on mechanism of light-dependent germination of akinetes of blue-green algae. Page 8 in Abstracts of 11th international seaweed symposium. Qingdao, China.
5. Bai Ke-zhi, Zhong Zepu, and Song Lirong. 1983. A simple and rapid method for the isolation of akinetes, proheterocysts and heterocysts in blue-green algae. Page 9 in Abstracts of 11th international seaweed symposium. Qingdao, China.
6. Braune, W. 1979. C-phycoyanin — the main photoreceptor in the light-dependent germination process of *Anabaena* akinetes. Archives Microbiol. 122:289-295.
7. Mohr, H. 1980. Interaction between blue light and photomorphogenesis. Pages 97-109 in The blue light syndrome. H. Senger, ed. Springer Verlag Press, Berlin.
8. Reddy, P. M., and E. R. S. Thalpasayi. 1981. Some observation related to red-far red antagonism in *Anabaena ferrilisima*. Biochem. Physiol. Pflanzen. 176:105-107.
9. Wolk, C. P. 1965. Control of sporulation in a blue-green alga. Dev. Biol. 12:15-35.

**USE OF *AZOLLA*
FOR MULTIPLE PURPOSES**

Reevaluation of *Azolla* utilization in agricultural production

LIU CHUNG-CHU

Fujian Academy of Agricultural Sciences

Fuzhou, China

For too long *Azolla* has been studied mainly as a source of N for rice fields. Most literature on *Azolla* revolves around this rather limited application. The techniques for cultivation and utilization of *Azolla* have been developed from the traditional methods of growing *Azolla* in association with rice and incorporating it as a fertilizer. Our recent investigations, however, show that the potential for *Azolla* in agricultural production goes far beyond its N₂-fixation capability or its use as green manure. A reevaluation of *Azolla* to develop new ways to utilize it and to give it full play in agricultural production is recommended.

AZOLLA AS A POTENTIAL POTASSIUM SOURCE

Azolla contains 2-3.5% K. Where does the K come from and what is its effect on rice plants? To answer these questions, we have conducted experiments since 1979 to determine the source of *Azolla* K and its utilization by the rice plant.

Potassium-enriching capability of *Azolla*

Azolla has a strong ability to concentrate K from the water in which it grows. Our data show that the peak for K absorption of *Azolla* is around 0.85 ppm K₂O when cultivated in various concentrations of K medium, i.e. 1g *Azolla* biomass is able to take up about 70% of K from 800 ml of culture solution containing 0.85 ppm K₂O in 1 d (Fig. 1). This may be considered the physiological critical point of *Azolla*'s K requirement.

Generally, the kinetic curve of K uptake by the rice plant is similar to that of *Azolla*, but the level is different. Peak of K uptake for rice is 8 ppm, so the physiological critical value of K for rice is 10% lower than that of *Azolla*. The capability of the rice plant to recover K reaches 0 when the K concentration in exterior solution decreases to about 1.05 ppm. If it drops further, the dynamic equilibrium between K absorption and K excretion is negative (Fig. 2). The natural K concentration in irrigation water of rice fields is about 1-5 ppm K₂O under the utilization range of *Azolla*, hence *Azolla* can concentrate trace K and release it to rice after it is incorporated into the soil.

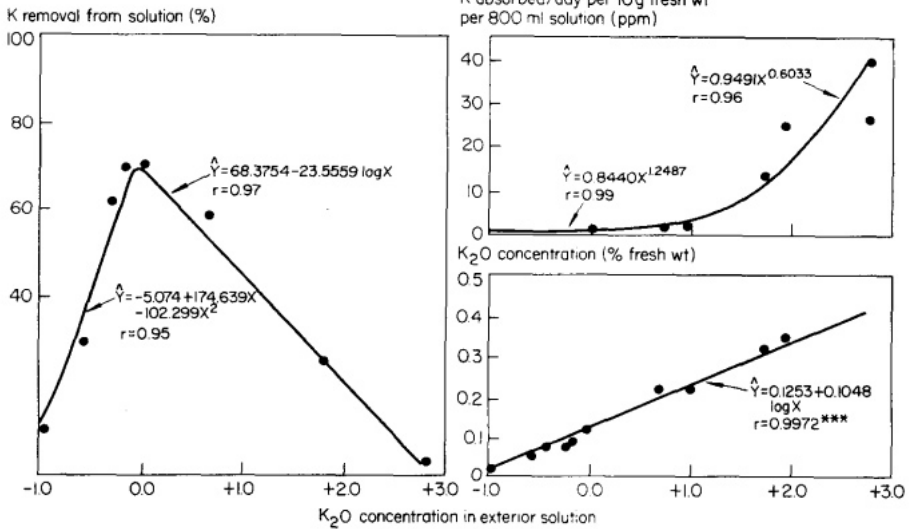

1. K absorption by *Azolla* from solution and K_2O content in *Azolla* as related to K_2O concentration in exterior water.

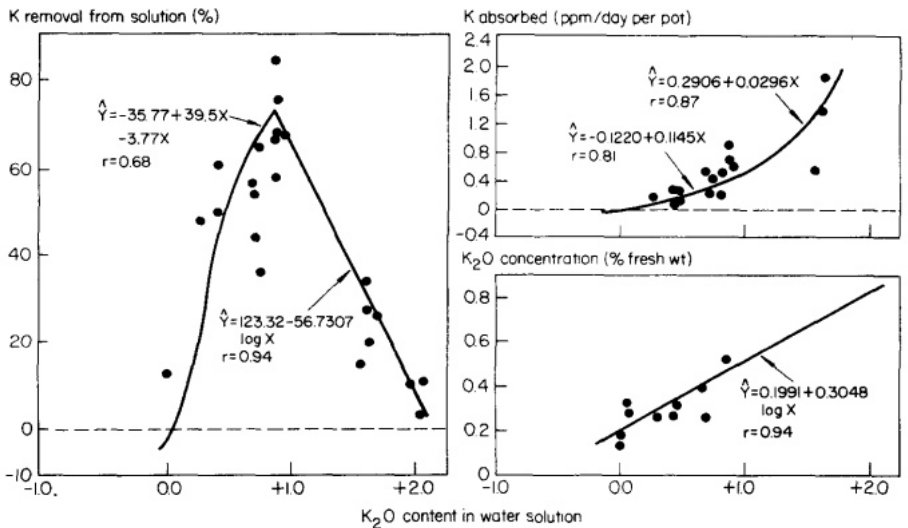

2. K absorption by rice from solution and K_2O concentration in plant as related to K_2O concentration in solution.

Efficiency of *Azolla* potassium on rice

Because it releases K rapidly, if we incorporate *Azolla* biomass into soil 1 wk before early rice transplanting and assume 80% K efficiency in the same cropping season, *Azolla* K efficiency is equal to or better than that achieved by applying an equal amount of chemical K (Fig.3). When *Azolla* decomposes, its

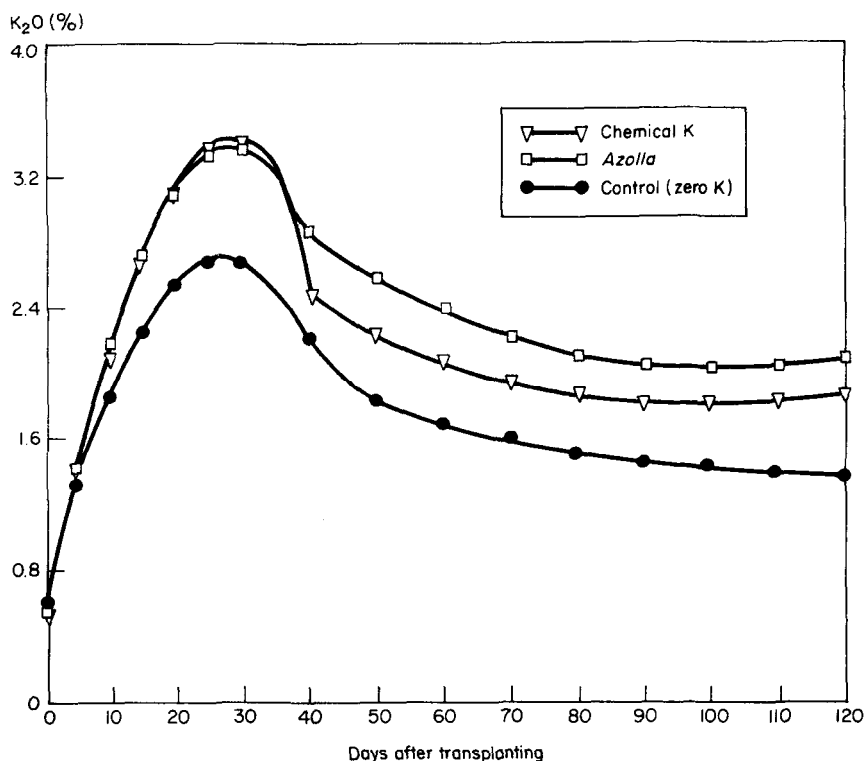

3. The dynamic change of K content in rice plant as affected by various K sources.

K content is excreted mainly in the form of available or slowly available K. The available K in water does not increase (Fig. 4), so runoff and leaching losses are less important. The amount of K released can meet the rice crop requirements throughout its growth. As a result, the K supply and the K content of the rice plant are greatly increased. It must be noted that if we apply 70% *Azolla* and 30% chemical fertilizer to the rice crop, the N supply may be increased at an earlier stage, because *Azolla* N, as shown by many experiments, is released slowly and the utilization rate is lower in the same cropping season. It is reasonable to conclude that this method of applying fertilizer may also improve K supply at an earlier stage, giving full play to the K-supplying ability of *Azolla*.

Pot and plot experiments were conducted on different soils of plain and mountain areas in Fujian Province in 1984. The focal point was in the mountainous area because soil fertility is low and K deficiency is easily observed. Highest yields were achieved with an application of 70% *Azolla* and 30% inorganic fertilizer (Table 1).

Azolla is an excellent and effective K source, and may be a potential source of biological K in rice producing areas.

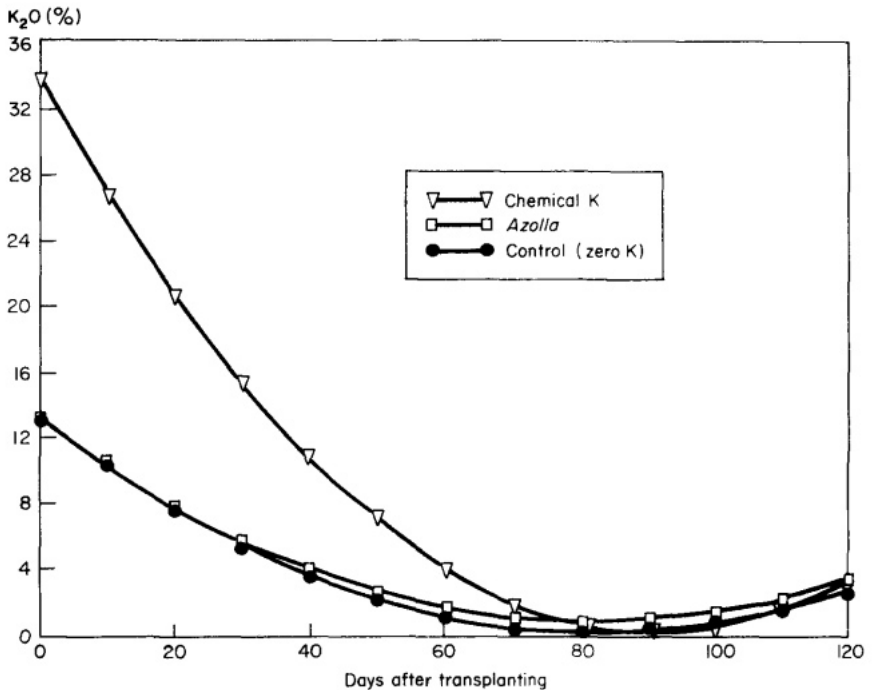

4. The dynamic change of available K of water as affected by various K sources.

Table 1. Effect of application of *Azolla* and fertilizer on rice yield (extrapolated from pot and plot experiments).

Treatment	Rice yield (t/ha)	
	Av 12 sites in Fujian	Av 3 sites in plains area
70% <i>Azolla</i> + 30% fertilizer	5.6	5.3
100% chemical fertilizer (NPK)	5.3	5.1
N, P	4.7	4.0
Control, no fertilizer	3.5	3.0

Potassium enrichment in the water-soil system

Azolla is grown mostly in paddy fields in shallow water. The total system is in a water-soil condition, and K is under dynamic equilibrium. We need to know if *Azolla* growing on the water surface and concentrating K from the water layer affects the K content in soil. How much *Azolla* K comes from water and how much comes from soil?

Several experiments have shown that when the K concentration in exterior water is between 2 and 50 ppm K₂O, K absorption of *Azolla* from water does not affect soil K content despite a high (50 ppm K₂O) or medium (6 ppm K₂O) K concentration. When the initial K concentration of exterior water in the soil-water system is 50 ppm, total K in soil increases greatly after 4-5 wk in both treated and nontreated plots (Table 2). The slowly available K

Table 2. Effect of K concentration in culture solution on K content in soil after 4 wk.

Treatment ^a	K content in soil		
	Total K (%)	Slowly available K (ppm K ₂ O)	Available K (ppm K ₂ O)
		<i>50 ppm K₂O</i>	
No <i>Azolla</i>	6.24	587	281
<i>Azolla</i>	6.24	659	252
		<i>6 ppm K₂O</i>	
No <i>Azolla</i>	3.05	490	118
<i>Azolla</i>	3.19	503	117
		<i>2 ppm K₂O</i>	
No <i>Azolla</i>	3.22	480	104
<i>Azolla</i>	3.23	463	103

^a The solution in the 50 ppm K₂O treatment was changed weekly; that in 7 ppm was changed every 3 d; that of 2 ppm K₂O was changed daily.

and available K did not change significantly, which could be attributed to movement of K from solution into soil. When the K concentration in exterior solution was 6 ppm, the amounts of total K, slowly available K, and available K in treated or nontreated plots did not differ significantly. When the K concentration was 2 ppm, as when the solution had to be changed daily, the three types of soil K showed no significant difference. These results mean that if the soil-water K concentration can be maintained at 2 ppm K₂O, the K absorbed by *Azolla* is mainly from water and has little influence on the K content in soil.

Results from two experiments showed that the K content in *Azolla* grown in the same concentration of K₂O solution, with or without soil, were almost the same (Fig. 5). Regression analysis showed that the two dynamic curves of *Azolla* K content, with and without soil, are nearly congruent. The K required by *Azolla* is mainly enriched from water under these K concentration conditions.

The K content of *Azolla* growing in 50 ppm K₂O solution was higher than that of *Azolla* growing in 6 ppm K₂O. However, the K content of *Azolla* growing in 6 ppm or 2 ppm K₂O concentrations did not differ significantly. This may have been because the solution exchanges in the 6 ppm K₂O treatment were done every 3 d, and K concentrations determined at solution exchanging time varied from 1.8 to 6 ppm K₂O. On the other hand, exchanges in the 2 ppm K₂O treatment were done every day and K concentrations were between 0.25 and 2 ppm K₂O.

When the K concentration in exterior solution is kept at about 2 ppm, *Azolla* assimilates the K mainly from exterior water, regardless of whether the system has soil. The K concentration in field irrigation water is about 2 ppm, so the K content in *Azolla* biomass may come mainly from water instead of soil. Our experiment using ⁸⁶Rb technique has shown similar results.

For these reasons, we deduce that *Azolla* is not only a biological N source but an extremely promising source of biological K for the ricefield.

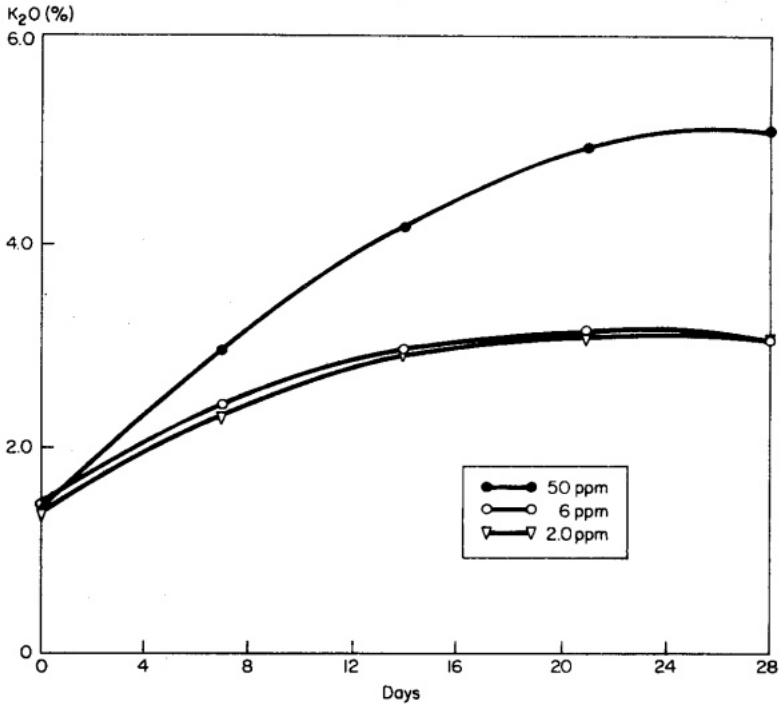

5. The dynamic change of *Azolla* K content in water-soil system.

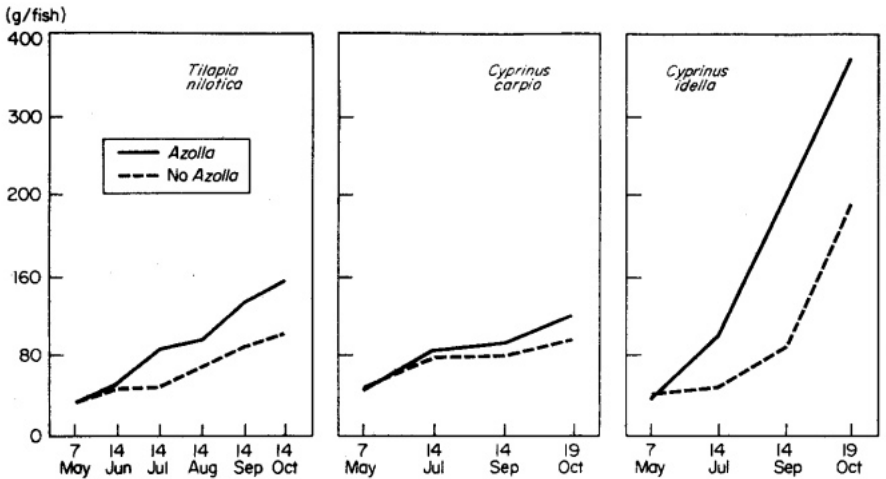

6. The increasing effect of *Azolla* on various species of fish.

RICE - AZOLLA - FISH SYSTEM

China has a long history of raising fish in ricefields. However, most of them are raised in single cropped ricefields. The growing period is rather short, no

definite feeds are used, and the strains used are mostly *Cyprinus idella* and *C. carpio*. Fish do not grow large enough for eating and are used only as fingerlings to raise in ponds the next year. Fingerling yield is usually 225-300 kg/ha.

We have raised fish in ricefields dual-cropped with *Azolla* since 1932 and have been successful in paddy fields using the double wide-narrow method. In the double wide-narrow method, paired rows spaced 13 cm apart are separated from other paired rows by spaces 53-66 cm wide. Plant spacing within rows is 6.5 cm. *Azolla* is cultivated in the wide spaces between paired rows through much of the rice crop growing season, increasing yields of rice and *Azolla*.

Rice yield slightly increased compared to control. Yield of early rice was 5.2 t/ha compared to 4.5 t/ha for the control; late rice yielded 5.7 t/ha compared to 5.3 t/ha for the control. The yield of fish products was 1 t/ha. Rice yield not only increased, but the edible yield of the fish increased (Fig. 6).

***Azolla* uptake by *Tilapia nilotica* and digestive rate**

Tilapia nilotica is an important fish in the rice - *Azolla* - fish system. It lives in the tropics and grows normally when water temperature is stable above 12°C; fastest when the water temperature is 25-34 °C. The trial showed that the amount of *Azolla* taken up by *T. nilotica* was about 50-80% of its body weight.

We used the internal indication method to determine the digestion rate of *Azolla* by *T. nilotica*. Digestive rate was 59.7 %.

Results of feeding ¹⁵N-labeled *Azolla* to *T. nilotica* showed that ¹⁵N was most abundant in the intestines and stomach. There also was considerable ¹⁵N in the gills. That may be because gills are not only the exchange site of O₂ and CO₂ but are an excretion organ as well.

The NPK content of fish feces

The ratio of N in fish feces was about 40% compared to that in *Azolla*. That means that about 60% of N fixed by *Azolla* from air was assimilated by fish and 40% of the N fixed was excreted in the feces. The phosphate content in *Azolla* was rather low and showed little change. However, the K content decreased significantly. We need more information to understand whether the total amount of K was utilized by fish or part of it was dissolved in water (Table 3). In summary, a 1-ha ricefield may produce as much as 75 t of *Azolla*, which may in turn produce 1.2 t of fish products and return an equivalent of 0.3 t ammonium sulfate to the paddy soil. The rice - *Azolla* - fish system consumes low energy, provides high income, and is a promising way to utilize *Azolla*.

Table 3. N, P, and K contents in *Azolla* and in feces of *Tilapia nilotica*.

Sample	N (%)	P ₂ O ₅ (%)	K ₂ O (%)
<i>Azolla</i>	4.87	0.66	2.53
Feces	2.23	0.91	0.19

Effect of rice - *Azolla* - fish system on the environment

Weed control. In the rice - *Azolla* - fish system and in the rice - fish system, weeds almost completely disappeared, and intensive labor for weeding was minimized. The almost total lack of weeds may be attributed to fish activity.

Sheath blight. As shown in Table 4, the rice - *Azolla* - fish system decreased the disease index. We need to determine whether the controlling function was fish, *Azolla*, or both.

Brown planthopper damage. Results of experiments showed that in the rice - *Azolla* - fish system, fish may effectively control brown planthopper. Brown planthopper populations were reduced 72.7 % in early rice and 77 % in late rice.

Azolla pests. The trial on rice - *Azolla* - fish system showed that *Chironomus* and *Pyralis* decreased significantly. In a 1984 experiment at Jianling County, where *Azolla* has been introduced, *Chironomus* population was reduced by 87% and the *Pyralis* population by 78%. Pests are a main problem in growing *Azolla* in the subtropics. Raising fish with *Azolla* may help solve the problem.

MOIST SOIL CULTIVATION OF AZOLLA

When cultivated on the water surface, *Azolla* multiplies rapidly and fixes N efficiently. However, there are problems with this method of cultivating *Azolla*:

1. It is difficult to incorporate *Azolla* into paddy soil.
2. *Azolla* growth is retarded when the field is drained for the growing rice.
3. Damage from pests, algae, snails, etc., is intensive during summer.

We need to explore a new way of cultivating *Azolla* to overcome these problems.

Some species of *Azolla* may be cultivated on the soil surface by the moist soil cultivation method. One advantage is that attacks of pests, alga, and snails are prevented. Because of the lack of water layer, *Chironomus* and *Pyralis* sp., two serious pests of *Azolla*, cannot survive. *Azolla* could then grow safely at the higher air temperature during summer. Another advantage is *Azolla* can grow in multiple layers. Although the upper layer turns red because of intensive sunlight, the lower layer remains green. The multiple layer growth of *Azolla* increases its density and minimizes labor for harvesting.

We have found that *A. caroliniana* grows on the moist soil surface without the water layer, and that it can tolerate low light intensity and resist rotting.

Table 4. Effect of rice - *Azolla* - fish system on sheath blight.

Treatment	Disease index			Av disease index	Disease index decrease
	Replication	Replication	Replication		
	I	II	III		
Rice	7.29	1.16	1.13	3.37	-
Rice - <i>Azolla</i> - fish	4.11	2.98	1.97	3.01	-0.36
Rice - <i>Azolla</i>	5.15	1.26	2.23	2.90	-0.47
Rice - fish	2.45	2.73	1.92	2.16	-1.21

These characteristics enable *A. caroliniana* to survive throughout the summer under the rice canopy. Under the early rice canopy, *A. caroliniana* can grow well on the cleft soil surface when the field is drained to meet the needs of the growing rice. After harvest and removal of the rice straw, *A. caroliniana*, covering the soil surface like green carpet, may yield 11-15 t/ha.

Azolla yields from the moist soil cultivation method vary with strain, environment, and technique. Table 5 shows the results from sites at two different environments during winter. Although the fresh weight of *Azolla* in the water cultivation method is higher than that in the moist soil cultivation method, the dry weight in the two methods does not differ significantly. This may be attributed to the lower water content of moist soil-cultivated *Azolla*.

Nitrogen-fixing activity between two species and two cultivation methods fluctuated. *Azolla* - N content was higher in water-cultivated *Azolla* method than in moist soil-cultivated *Azolla*. We need to further investigate and compare values of N fixation between moist soil and water cultivation. *Azolla* phosphate content in the experiments varied greatly, but K content was similar. The yields and nutritional content of *Azolla* cultivated by moist soil and water cultivation methods need to be further studied.

The success of moist soil cultivation of *A. caroliniana* and *A. filiculoides* has convinced us that moist soil cultivation is a useful new development in growing *Azolla*, especially in adverse conditions, and that it is a technical improvement over water cultivation. The method may be suitable in Asian countries where temperature is high.

OUTLOOK FOR AZOLLA

In view of the new perspectives on *Azolla* brought about by recent investigations, we have identified areas where more research is needed.

Table 5. Moist soil cultivation and water cultivation of *Azolla* in the field at two sites.

Cultivation method	Yield (g/m ²)	Dry wt (%)	Dry wt (g/m ²)	Nutrition content (%)		
				N	P ₂ O ₅	K ₂ O
<i>Lou Hia, Fuzhou, China</i>						
<i>A. filiculoides</i>						
Water cultivation	1245	5.0	62.3	4.8	2.1	2.4
Moist soil cultivation	795	6.2	49.3	4.5	1.8	2.3
<i>A. caroliniana</i>						
Water cultivation	975	4.9	47.8	4.1	2.7	1.7
Moist soil cultivation	645	6.4	41.3	3.6	2.2	1.6
<i>Fujian Academy of Agricultural Sciences, Fuzhou, Fujian, China</i>						
<i>A. filiculoides</i>						
Water cultivation	2888	5.6	161.7	3.5	0.8	2.1
Moist soil cultivation	2716	6.0	163.0	3.0	1.1	1.9
<i>A. caroliniana</i>						
Water cultivation	1546	6.4	98.9	4.2	0.6	1.9
Moist soil cultivation	930	8.2	76.3	3.9	1.0	1.9

Studies in the following areas should contribute to the wider utilization of *Azolla*.

1. Because of the value of *Azolla* as a feed for livestock and poultry, investigations should include digestion rate of *Azolla*, nutrient efficiency, silage, drying, and protein content.
2. Studies on the rice - *Azolla* - fish system should include nutrition and management of fish, distribution and transformation of the N fixed by *Azolla* and P in the fish body and rice plant, and development of a comprehensive technical system to obtain high yields of rice, *Azolla*, and fish.
3. Basic research on *Azolla* should include studies to identify and classify *Azolla* strains and their algae symbionts; studies of photosynthesis, N fixation, N fixing efficiency in the field, and synthesis and mechanisms; and studies on the process of *Azolla* -algae recombination and the possibility of breeding new strains.
4. Research is required on the technology for intensive *Azolla* cultivation, including the arrangement of *Azolla* species, and the nutrition and environmental conditions for *Azolla* growth. The aim of this research would be to develop effective comprehensive techniques to grow *Azolla* throughout the year and to produce 500-600 t/ha annually.
5. New *Azolla* strains should be bred by techniques such as sexual hybridization, cell fusion and recombination, etc., to produce new strains higher in protein, more digestible, tolerant of adverse conditions, and higher yielding.

Azolla collection and selection

C. VAN HOVE AND T. DE WAHA BAILLONVILLE

Laboratoire de Physiologie Végétale
Université Catholique de Louvain
Place Croix du Sud, 4, B-1348
Louvain-la-Neuve, Belgium

H.F. DIARA

Azolla Project
West Africa Rice Development Association
B.P. 96, St. Louis, Senegal

AND

P. GODARD, Y. MAI KODOMI, AND N. SANGINGA

Université Catholique de Louvain

Azolla utilization requires the selection of the best strains for a given use in given ecological conditions. There are at least three prerequisites: 1) development of living *Azolla* reference collections, 2) characterization of *Azolla* population growth curves, and 3) productivity measurements. The difficulties of maintaining vegetative collections are discussed and methods for reducing labor required and the risk of intermixing morphologically similar strains are presented. Preliminary results on the effect of *Azolla* strain and population density on quantitative and qualitative productivity are given. A standardized method for measuring productivity throughout the year is described and first results are presented.

Recent efforts to introduce *Azolla* into various tropical and subtropical countries for use as green manure and food have met with varying success. One of the first questions to be solved is which species and strains to use. Precise information on ecological requirements and on qualities of various *Azolla* strains is lacking and the need for reference collections is increasingly evident. Maintenance of collections presents great problems. Lack of control of sexual reproduction prevents maintenance of material as spores, and culturing these tiny, often morphologically similar, plants introduces the risk of intermixing strains. We describe how we maintain our reference collection and search for characterizing, by chemical fingerprints, every introduced strain. Exploiting a reference collection that is as diversified as possible requires selecting the most valuable strain for any given ecological condition. Qualities required are high productivity and chemical composition favorable for the proposed use. To estimate *Azolla* productivity we tried to identify the most important parameters of their population growth curves. Preliminary results from laboratory and field studies, which bear on rough productivity and qualitative aspects of the biomass, are presented.

REFERENCE COLLECTION MAINTENANCE AND STUDY

Development of *Azolla* reference collections is becoming more urgent and poses two kinds of problems: 1) adoption of appropriate methodologies for their maintenance, and 2) the need for international conventions ensuring unambiguous identification of the origin of each accession, especially in exchanges between collections.

To simplify maintenance of our *Azolla* collection and accomplish comparative assays, we designed adapted culture baths (Fig. 1). A cyclic flow of dilute (4: 10) Hoagland solution in which nitrates are replaced by chlorides circulates at a rate of 40 liters/min between a 1.1-m², 80-liter plexiglass culture bath and a 50-liter tank. Evapotranspiration is compensated for by automatic addition of deionized water into the tank, and at each cycle the solution is filtered on glass wool. Temperature of the medium is controlled, conductivity and pH are monitored.

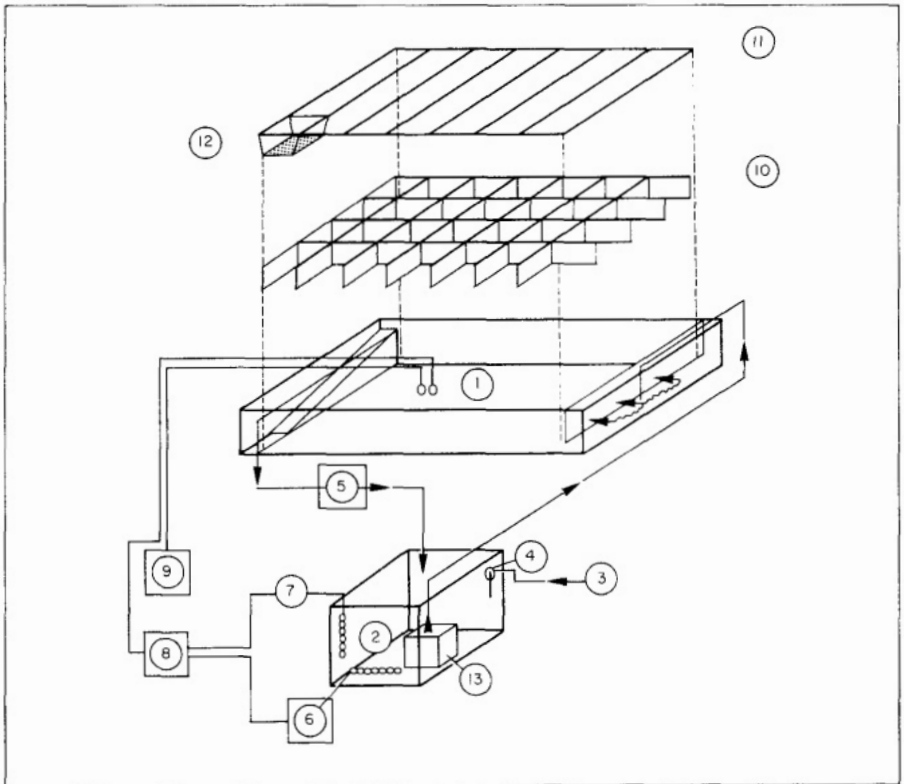

1. *Azolla* culture bath: 1) bath; 2) tank; 3) deionized water supply; 4) adjusting level water gate; 5) filter; 6) refrigeration unit; 7) heating unit; 8) temperature control unit; 9) pH conductivity meter; 10) compartments corresponding to variation 1; 11) lattice corresponding to variation 2; 12) mobile 1-liter culture box with mosquito net bottom; 13) circulation pump (arrows represent solution flow direction).

In one variation of this device used for collection maintenance, the bath is subdivided into rectangular compartments whose walls do not reach the bottom of the bath, allowing free circulation of the solution between all the compartments. Within limited space (1.1 m²) and with minimum careful manipulations, 148 strains are maintained. The culture medium is replaced monthly and *Azolla* populations are thinned according to needs. Standard conditions are: solution temperature: 31-20 °C; photoperiod: 14 h light, 10 h dark; light intensity: 170±20 μE/m² per s; relative humidity: 55-65%; pH 5.00±0.4.

In another variation for growth experiments, a plexiglass lattice at the surface of the culture medium supports 40 1-liter plastic boxes (165 cm²) with the bottom replaced by a mosquito net. This device allows periodical weighing of the *Azolla*, after standardized drainage, with minimum disturbance of the populations cultivated in each box.

We have adopted the following convention for identifying accessions in our collection. Each new strain receives a chronological entry number preceded by the acronym ADUL (12). As soon as the strain's taxonomic position is determined, the entry number is followed by two letters according to the following code: CA = *A. caroliniana*, FI = *A. filiculoides*, ME = *A. mexicana*, MI = *A. microphylla*, NI = *A. nilotica*, PI = *A. pinnata* var. *imbricata*, PP = *A. pinnata* var. *pinnata*, RU = *A. rubra*.

AZOLLA IDENTIFICATION AT THE SUBSPECIFIC LEVEL

Preliminary results (6), obtained by thin layer chromatography, suggested that phenolic compounds analysis could provide fingerprints for *Azolla* identification at the subspecies level, allowing control of reference collections.

To increase sensitivity of the method, new extraction procedures and quantitative analyses of the extracts by high performance liquid chromatography (11) have been adopted. Twenty-one *A. pinnata* var. *pinnata* and 23 *A. pinnata* var. *imbricata* strains, cultivated in the standard conditions previously described, have been treated by these methods. Computation of the similarity matrix between strains (4), followed by cluster analysis based on the median method of Gower (3), allows the establishment of a dendrogram grouping strains according to their phenolic compounds composition (Fig. 2). This dendrogram shows that none of the analyzed strains present identical patterns and that the varieties are well separated except in two cases. Although promising, the method is not yet operational because of difficulties in obtaining perfectly reproducible chromatographic separations. We are now trying to solve these technical problems.

ANALYSIS OF AZOLLA POPULATION GROWTH CURVES

Optimal management of *Azolla* cultures requires knowledge of their growth curve parameters. Sixteen strains, representing the eight usually recognized

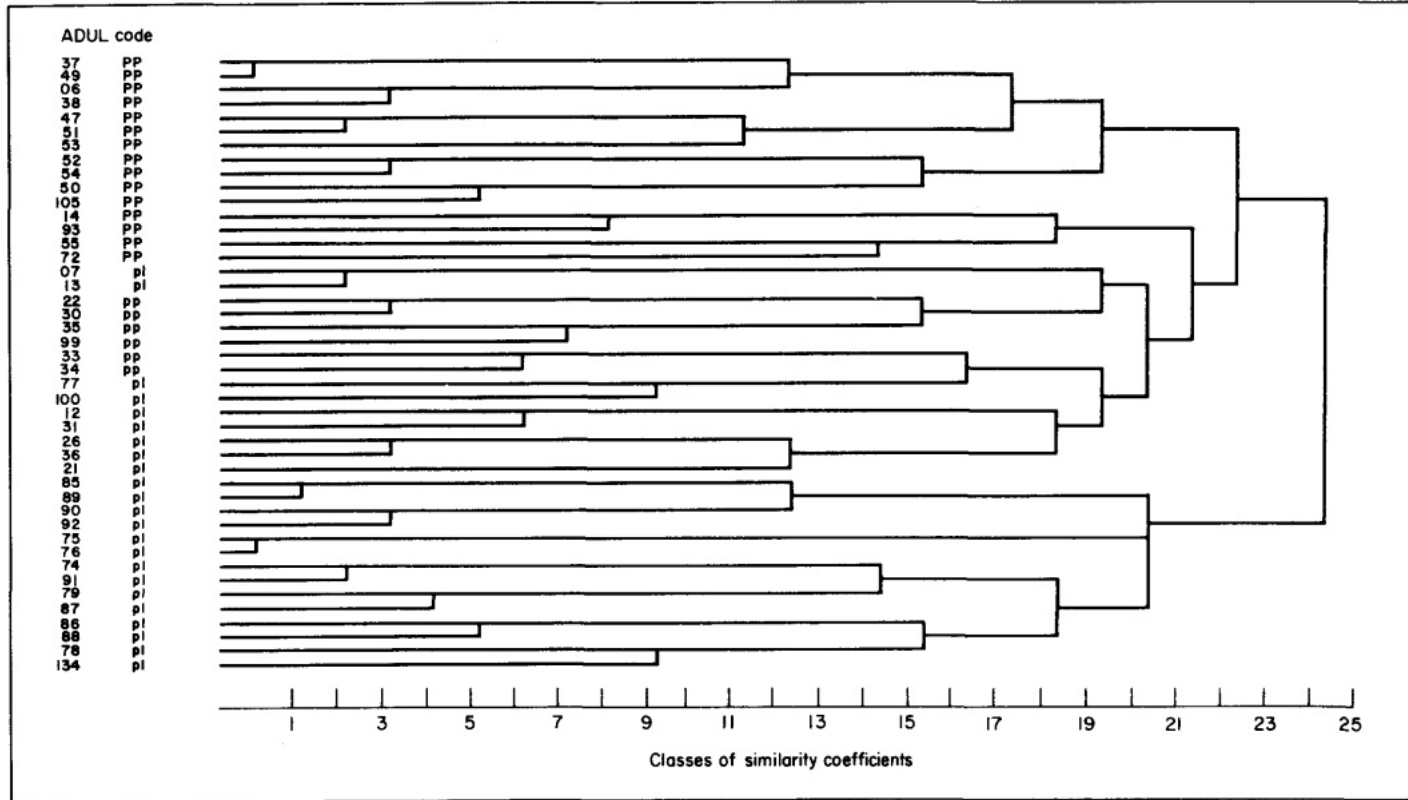

2. Dendrogram established by the median method of Gower from the profile data of the 44 chromatograms of *A. pinnata* extracts. Each strain is coded by its collection accession number.

species and varieties, were cultivated and their growth curves measured. The method described for growth experiments was followed except that inoculation density was 1 g/box (60 g/m²); solution renewal: weekly; light intensity: 350±50 E/m² per s; photoperiod: 16 h light, 8 h dark; relative humidity: 70-90%.

From statistical treatment of the data by the Nelder model (7, 8), it appears that the Gompertz function (10) describes the 32 growth curves obtained. Figure 3, for example, shows the experimental growth curve obtained with strain ADUL-4-FI, as well as the calculated corresponding Gompertz curve and its derivative, which characterizes growth rate or productivity.

The growth curves present three values of special practical interest, allowing the subdivision of the growth curves into four growth phases: exponential, linear, sowing, and constant. The values are:

1. *Maximum productivity* (P_M) denoting maximum biomass produced by unit of time.
2. *Mean productivity* (P_m). According to the Gompertz function, $P_m = 0.68 P_M$. The period during which productivity is higher than P_m can be considered as representing a linear growth phase. Maintaining *Azolla* populations within the limits of this phase allows maximum biomass production with minimum labor. That is, inoculum density ideally should correspond to the lower limit of the linear phase whereas harvesting or burying density should correspond to its upper limit.
3. *Maximum biomass* (M). This value corresponds to the asymptote of the Gompertz function. It allows the calculation of the limits of the linear phase whose lower limit is 0.700 M . The higher the M value, the longer the linear phase, and the more biomass produced during this phase. Hence, *Azolla* selection has to consider not only P_M but also M .

AZOLLA COMPOSITION AS AFFECTED BY POPULATION DENSITY AND STRAIN

The main characteristics influencing *Azolla* value as green manure are P_M , M , N content, N derived from N₂, cell wall composition, and C-N ratio. When *Azolla* is considered as food, other characteristics such as essential amino acids, lipids, and digestible carbohydrate contents are also important.

Preliminary results (2) have shown that *Azolla* composition is profoundly influenced by population density. Many data from the literature also suggest species or even subspecies differences, even though precise information about the growth phase at the sampling time is generally missing (5, 9).

Seven of the strains, whose growth curves had been analyzed previously, have been cultivated again under identical conditions to obtain samples corresponding to their four growth phases for duplicate analysis of their composition. The interpretation of the limited number of presently available results is complex and only general tendencies are shown here (Fig. 4).

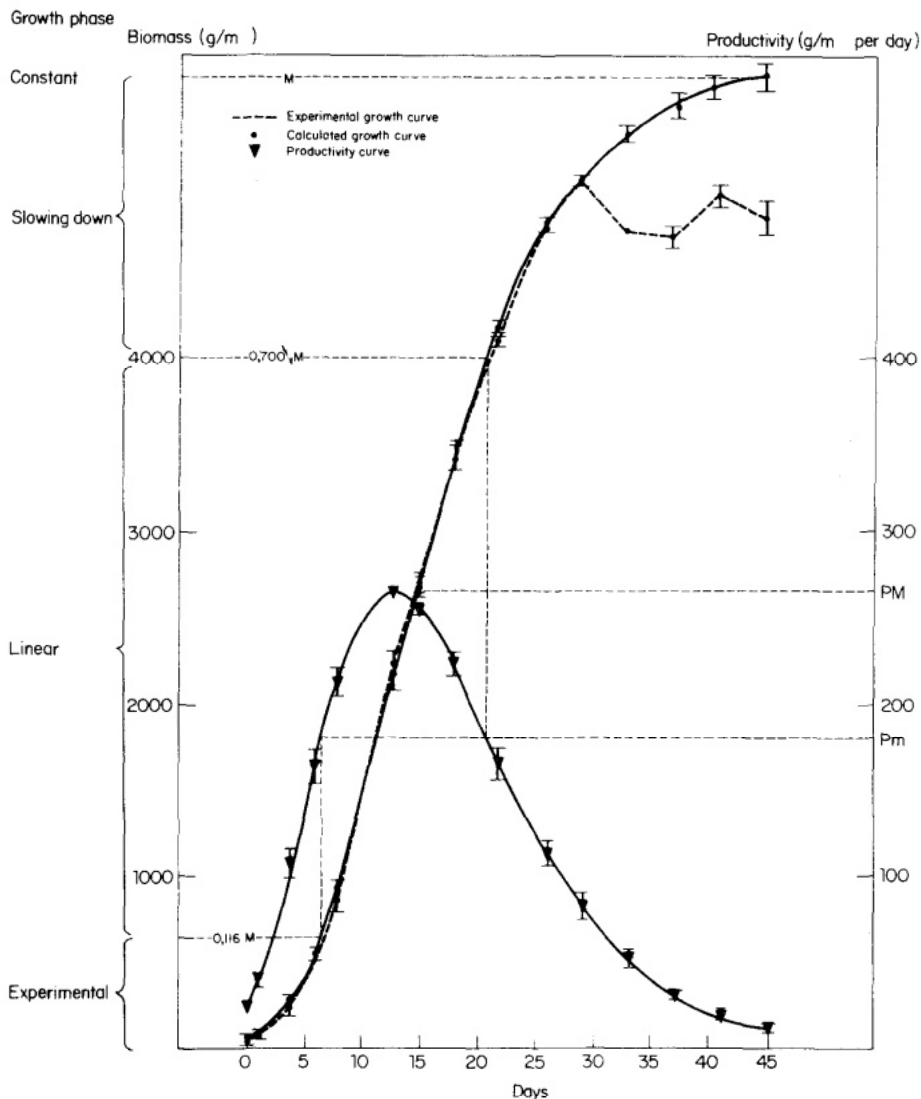

3. *A. filiculoides* (ADUL-4-FI) experimental and modeled growth curves, and productivity curve according to the Gompertz model.

For total N (N_t) (Fig. 4A), no clear-cut influence of the growth phase appears, but great differences between strains are evident. Extreme mean contents in the dry matter are 3.5% for FI and 5.3% for CA and ME. When looking at cell wall-linked N (N_w) (Fig. 4B), whose release during the decomposition process is very slow, a linear increase with time tends to be the rule. Here, too, great differences appear between strains. The range actually varies from 3.8% of N_t (MI, 1st phase) to 40% (ME, 2d phase). The C-N ratio

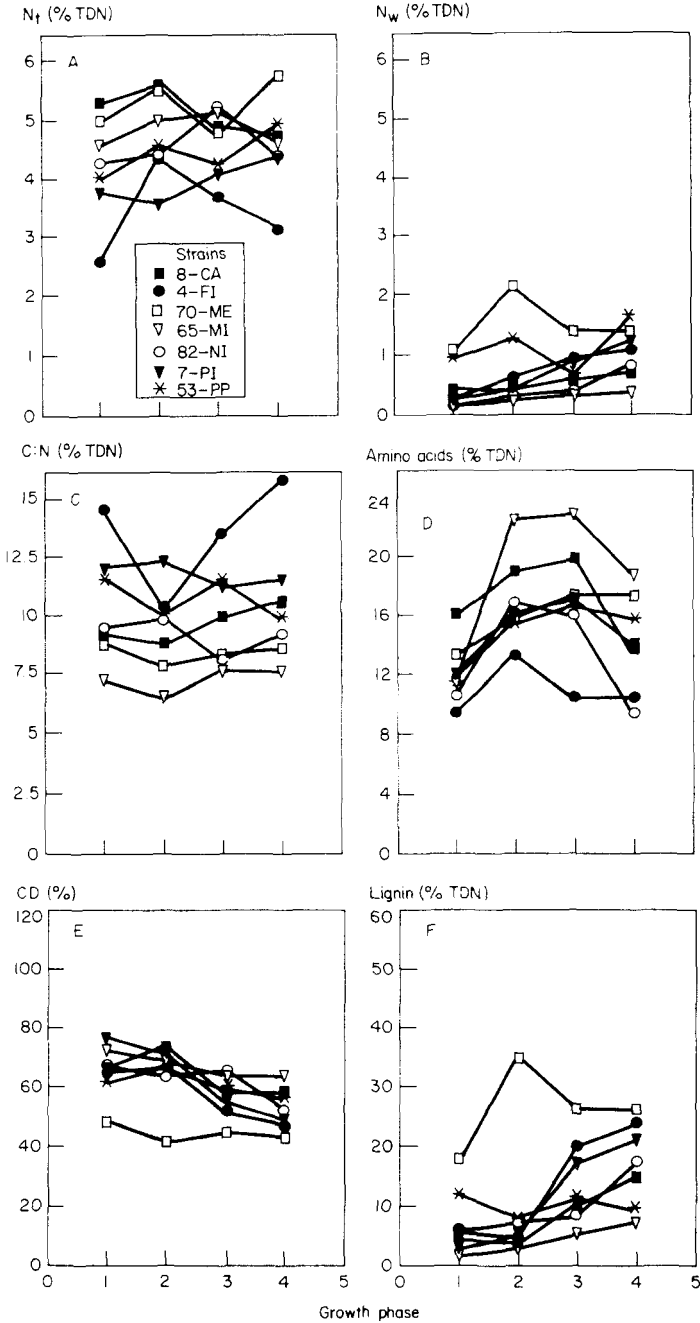

4. *Azolla* chemical composition as affected by strain and population age: A) total N (N_t); B) cell wall-linked N (N_w); C) C-N ratio; D) amino acid content; E) calculated digestibility (CD); F) lignin content.

Table 1. Essential amino acid content (% dry matter) of seven *Azolla* species during their linear growth phase.

Essential amino acids	Recommended value for pigs ^a	Amino acid content (% dry matter) ^b						
		65-MI	8-CA	53-PP	70-ME	82-NI	7-PI	4-FI
Methionine + cysteine	0.80	0.43 b	0.46 ab	0.23 bc	0.51 ab	0.52 a	0.21 bc	0.47 ab
Lysine	1.40	1.62 a	1.34 a	0.96 b	1.06 b	1.27 ab	1.15 b	1.04 b
Valine	0.90	1.07 a	0.86 a	0.97 a	0.75 a	0.82 a	0.88 a	0.79 a
Histidine	0.34	0.47 a	0.40 ab	0.32 b	0.32 b	0.37 ab	0.33 b	0.28 b
Isoleucine	0.80	1.07 a	0.85 ab	0.81 ab	0.75 ab	0.84 ab	0.76 ab	0.57 b
Threonine	0.80	1.13 a	1.03 a	0.84 ab	0.85 ab	0.91 ab	0.86 ab	0.68 b
Leucine	1.00	2.29 a	1.96 ab	1.71 b	1.66 b	1.71 b	1.79 ab	1.42 b
Arginine	0.36	1.90 a	1.58 ab	1.32 bc	1.33 bc	1.56 abc	1.43 abc	1.04 c
Phenylalanine + tyrosine	1.30	2.17 a	1.93 ab	1.45 c	1.45 c	1.51 bc	1.57 bc	1.29 c

^a For comparison, recommended values pigs at their most demanding growth stage, according to Blum (1), are presented. ^b Means in a row followed by a common letter are not significantly different at the 0.5 level.

(Fig. 4C), which also affects decomposition rate, remains roughly constant for a given strain but its value varies from ± 7 for MI to ± 13 for FI. As expected, lignin evolution (Fig. 4F) tends to parallel N_w evolution. Its concentration usually remains relatively low during the linear phase. Strain differences are considerable. The highest lignin contents attained were 35.5% of dry matter (ME, 2d phase) and 1.8% of dry matter (MI, 1st phase).

The linear growth phase is characterized by low lignin and N_w concentrations while N_t and C:N values do not change profoundly with time. Knowing that productivity is maximal during the linear growth phase, burying *Azolla* during the linear growth phase seems justified if rapid decomposition is wanted.

Lignin content is also one of the main factors affecting the nutritive value of *Azolla*. This is clearly shown in Figure 4E, which represents the calculated digestibility (CD) (13). Digestibility clearly decreases with the development stage of *Azolla* populations, and great species differences appear.

Another important factor to consider when *Azolla* is considered as food is its amino acid content, which is maximum during phases 2 and 3 (Fig. 4D). Again, important species differences appear.

Such species differences also appear when essential amino acid composition is considered. Table 1 presents results corresponding to the linear growth phase, which are similar to those from phase 3 and better than those corresponding to phases 1 and 4. If we compare the composition of the seven *Azolla* strains with recommended food composition for pigs at their most demanding growth stage (1), strain 65-MI is the best, with only a deficiency in sulfur-containing amino acids. Strain 4-FI is the poorest.

PRODUCTIVITY IN THE FIELD

Recently 85 *Azolla* strains were introduced at the Richard Toll West Africa Rice Development Association (WARDA) research station in Senegal to compare their productivities in the field throughout the year. Thirty strains did not adapt to the local conditions and were discarded or died. Among those that died were the three *A. nilotica* strains, two *A. rubra* strains, and one *A. mexicana* strain.

Growth curves of the 55 remaining strains have been measured using the method described by Van Hove et al (12) and the limits of their linear growth phases calculated. Since then, each strain has been permanently maintained within the limits of its linear growth phase. Biomass is collected weekly, then weighed, dried, and stored for chemical analysis.

Figure 5 shows mean productivities for each strain after 20 wk. Analysis of the correlation between the evolution of these productivities and climate is under way.

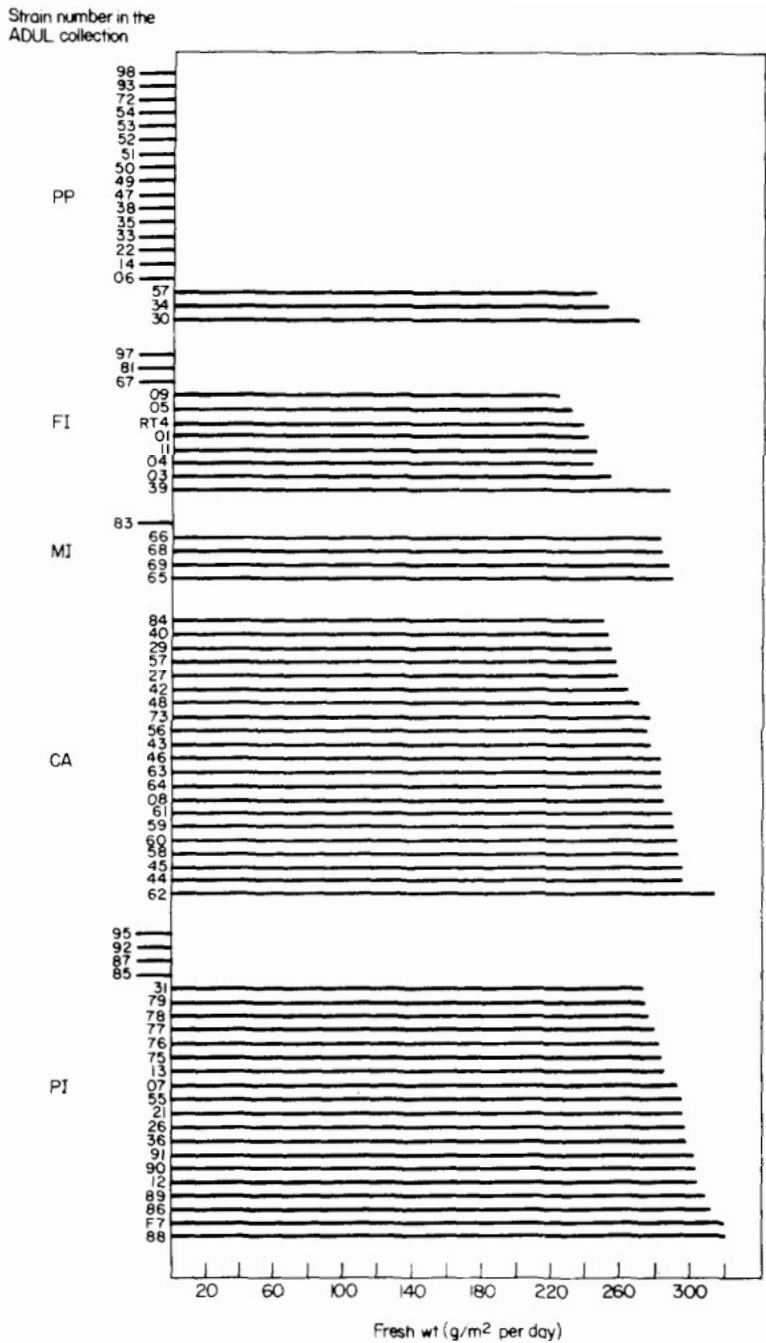

5. Mean daily productivity in the field of 79 *Azolla* strains in 20 wk, 13 Aug-31 Dec 1984. Strains noted as having negative productivities are those that did not grow during the period.

REFERENCES CITED

1. Blum, J.C. 1984. L'alimentation des animaux monogastriques. Institut National de la Recherche Agronomique, Paris, France. 282 p.
2. de Waha Baillonville, T., P. Godard, and C. Van Hove. 1984. Chemical composition of *Azolla* populations as affected by ageing. Arch. Int. Physiol. Biochim. 92(1):30.
3. Gower, J.C. 1967. A comparison of some methods of cluster analysis. Biometrics 23:623-637.
4. Gower, J.C. 1971. A general coefficient of similarity and some of its properties. Biometrics 27:857-871.
5. International Rice Research Institute. 1983. Nutritive value of *Azolla*. Pages 74-75 in Annual report for 1982. P.O. Box 933, Manila, Philippines.
6. Mai Kodomi, Y., P. Godard, and C. Van Hove. 1984. Flavonoid analysis in the genus *Azolla*. Arch. Int. Physiol. Biochim. 92(1):34-35.
7. Nelder, J.A. 1961. The fitting of a generalization of the logistic curve. Biometrics 17:89-110.
8. Nelder, J.A. 1962. An alternative form of a generalized logistic equation. Biometrics 18:614-616.
9. Peters, G.A., R.E. Toia, Jr., W.R. Evans, D.K. Crist, B.C. Mayne, and R.E. Poole. 1980. Characterization and comparisons of five N₂-fixing *Azolla* - *Anabaena* associations. 1. Optimization of growth conditions for biomass increase and N content in a controlled environment. Plant Cell Environ. 3:261-269.
10. Richards, F. J. 1969. The quantitative analysis of growth. Pages 3-76 in Plant physiology, a treatise. Vol. 5.A. Analysis of growth: behavior of plant and their organs. F.C. Stewards, ed. Academic Press. New York.
11. Van de Castele, K., H. Geiger, and C.F. Van Sumere. 1982. Separation of flavonoids by reversed phase high performance liquid chromatography. J. Chromatogr. 240:81-94.
12. Van Hove, C., H.F. Diara, and P. Godard. 1983. *Azolla* en Afrique del l'Quest - in West Africa. Ed. Impr. E. Oleffe, Belgique. 56 p.

DISCUSSION

KANNAIYAN: How do you distinguish your term maximum productivity from relative growth rate?

VAS HOVE: Relative growth rate (RGR) is the biomass produced per unit of biomass and per unit of time (generally expressed as g/g per day). It is maximal, and constant, during the exponential growth phase, then decreases progressively. Maximum productivity is the maximum biomass produced per unit of time. It gives a better estimate of the real potential of *Azolla* than RGR.

Environmental requirements for successful *Azolla* growth

T.A. LUMPKIN

Department of Agronomy and Soils
Washington State University
Pullman, Washington, 99164-6420, USA

Azolla is traditionally grown under cool, wet conditions. The plant prefers a placid water surface, temperatures between 20 and 35 °C, water pH of 4-7 and rich in all essential plant nutrients except N, solution salt content <0.3%, exposure to >25% full sunlight, long daylength, and freedom from competitors, insects, and diseases. Efforts to expand its use in the humid tropics have met with limited success and a host of environmental problems. High temperatures and humidity stimulate insects and diseases that attack *Azolla*. Algal blooms compete for nutrients and cause a change in pH and poor water circulation. Areas dependent on monsoon rains rarely have water for multiplying *Azolla* before the rice growing season and usually suffer from intermittent droughts, which desiccate intercropped *Azolla*. Excessive rainfall and typhoons can cause flooding, which can wash away the entire *Azolla* crop. Water is usually deficient in P and the applications of phosphate fertilizer and possibly other nutrients such as Fe, Mo, and K are required for the *Azolla* crop.

Azolla is an aquatic fern which has potential for expanded use as a green manure for rice. In placid water where available N is low, *Azolla* has a competitive advantage over other floating plants because of its symbiotic relationship with N-fixing endophytic cyanobacteria called *Anabaena azollae*. The *Anabaena* can supply the entire N requirement of the *Azolla* even at growth rates of about 35%/d. In turn, under suitable environmental conditions, *Azolla* can supply the entire N requirement for a high-yielding rice crop (50-100 kg N) in 10-20 d. For example, an *Azolla* mat weighing 10 t/ha and increasing its biomass at 20%/d, (relative growth rate [RGR] of 0.2) could fix up to 4.8 kg N/d, assuming a 6% dry weight and a N content of 4% dry weight, i.e., $10,000 \text{ kg fresh wt} \times 0.2 \text{ RGR} \times 0.06 \text{ dry wt} \times 0.04 \text{ N dry wt}$.

Azolla is also more cold tolerant than most other aquatic plants. This tolerance allows *Azolla* to flourish during cool seasons with little competition from other plants and damage from pests. Chinese (30) and Vietnamese (46) farmers recognized *Azolla*'s potential and have utilized it for centuries as a cool-season green manure. In China, *Azolla* is grown in the south during winter and cultivation advances north to central China with the coming of

spring to cover an area estimated to be more than 680,000 ha. In northern Vietnam, *Azolla* is primarily grown during winter and was reported to cover an area of 700,000 in 1978 (7).

Outside of China and Vietnam, very few rice producing areas in the world have a wet-cool season for growing *Azolla* before the rice season. Usually water is not available or temperatures are very high before rice is transplanted, such as in the months before the monsoon in South and Southeast Asia.

Even if environmental conditions are favorable, *Azolla* is usually difficult to grow. For field multiplication of *Azolla*, farmers will need 1-5 t of *Azolla*/ ha as planting material. This massive amount of plant material will be expensive and must come from one of three basic sources or combinations of these sources as illustrated in Figure 1. Because large-scale use of spores (12, 13, 14, 18, 47, 56) is not yet possible, farmers must either keep a nursery throughout the off-season or buy *Azolla* plant material from people who grow *Azolla* for sale. People who produce *Azolla* planting material for sale may also grow *Azolla* throughout the year as fodder for pigs, ducks, or fish. This combined type of system may be most practical for the tropics and should be encouraged by government programs. Fodder producers can multiply their *Azolla* stocks and sell to farmers as the rice/*Azolla* season approaches.

A planting level of 1-5 t/ha is necessary to adequately exploit the available water and sunlight. From this level, the *Azolla* is multiplied in the field as a monocrop or intercrop to attain a biomass of 10-80 t. From this level a single or multiple soil incorporations are carried out so that *Azolla* N can become available to a following or standing rice crop. The level of *Azolla* biomass varies according to cropping intensity and environment. Biomass is kept at a lower density under intense cropping to keep *Azolla* at its highest rate of productivity on a unit area basis (10). Only lower levels of biomass (10-30 t/ha) are currently possible under hot humid conditions because of insect and disease problems.

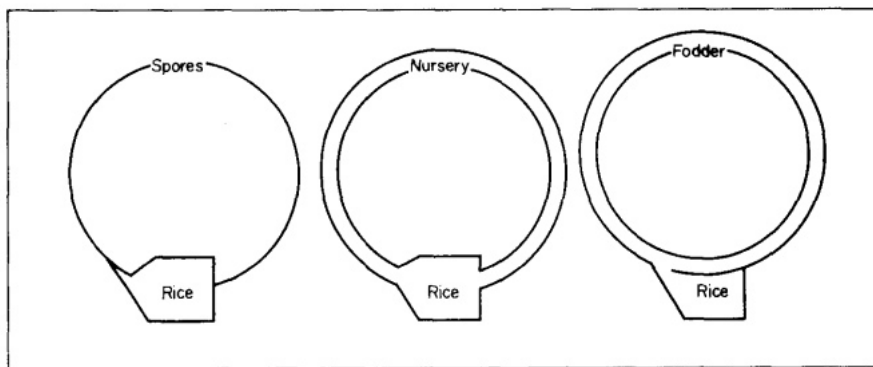

1. The three basic methods of maintaining *Azolla* planting material during off-seasons. These methods can be combined. About 3 wk must be allowed for germination of spores and development to dividing plants.

International (15) and national institutions are currently selecting varieties and developing management practices that will allow *Azolla* to become an important green manure for rice farming systems in the tropics. *Azolla* cultivation in China and Vietnam is generally limited to cool seasons because hot humid weather brings a host of environmental problems to an *Azolla* crop (26). These problems are so devastating that most farmers will not attempt summer cultivation of *Azolla* in paddy fields. I describe the environmental requirements for cultivation in hot humid conditions and review research articles about environmental constraints. I will expand on previous reviews of *Azolla* literature (4, 27, 30, 33).

ENVIRONMENTAL REQUIREMENTS

Climate, especially the climatic variables that affect *Azolla* growth, is difficult to manipulate. To determine the climatic variables and interactions that most influence *Azolla* growth, climatic variables were regressed on the RGR of *Azolla* species (28) that had been grown in a year-round pot experiment (2). The correlation analysis of data recorded during hot humid weather indicated that temperature and humidity had a negative effect on growth rate and solar radiation had a positive influence.

Although it may be possible to develop management practices that give some degree of control over these variables (52), the environment in which *Azolla* lives encompasses many other interacting factors. For example, *Azolla*'s susceptibility to fungal pathogens probably interacts with high temperature and humidity. Algal blooms not only compete with *Azolla* for nutrients but also cause a change of pH in the paddy water which can result in loss of nutrients from solution. They also restrict water movement which can result in high water temperatures lethal to *Azolla*. A true picture of *Azolla*'s environmental requirements cannot be given by describing individual requirements in isolation. Often the interactions or indirect effects of factors are more important than the direct effect. Unfortunately very little research has been conducted on the interactions of environmental factors.

Environmental factors

Water. The lack of good control and availability of water in rice growing areas is the primary constraint to the spread of *Azolla* use. As a delicate aquatic plant, *Azolla* can survive only for a few minutes on a dry surface under the tropical sun, and for a few days on paddy soil that dries during intermittent rains. Some varieties can survive indefinitely on moist, shaded mud, but will not multiply to any useful extent without a water surface on which to spread. Thus, without good water control and availability, *Azolla* multiplication may not succeed.

The need for water extends beyond the growing season and remains important to a limited extent throughout the year. A small amount of water must be available to maintain nursery stocks of *Azolla* plants during the

off-seasons. A larger amount of water will be needed for the multiplication of this nursery before wide-scale field multiplication begins as the rice season approaches. Unfortunately, a large quantity of water is usually not available for growing *Azolla* just before the rice crop is planted.

The source for water is also important. Like rice, *Azolla* grows better during dry seasons when irrigation water is available. If water comes from precipitation, additional problems may occur. A rice farmer on the east coast of India, Vietnam, and China, or anywhere in the Philippines can have his entire *Azolla* crop washed away by a typhoon. Farmers in a monsoon area can suffer the same fate from excessive rainfall, which causes flooding. With the exception of a few areas such as South Cotabato in the Philippines (48), most farmers will need to invest considerable effort to produce an *Azolla* crop. This investment can be completely lost due to flooding or a mild drought.

Light. The growth rate of *Azolla* has been reported to saturate at 25-50% of full sunlight (2, 44), and is not inhibited by full sunlight as long as other factors are not limiting (3). As an intercrop under rice, the growth rate of *Azolla* will begin to decline as the developing rice canopy reduces light quantity and quality below that necessary to saturate growth rate. The rice canopy will start influencing growth about 2-3 wk after transplanting and will stop growth in most *Azolla* species at 45 d after transplanting, depending on such factors as rice maturation period, leaf area index, weather, paddy water fertility, etc.

An aspect of shading which is of possible interest but has not been studied is the intracrop shading of *Azolla* as it becomes crowded. As in other crops, crowding probably results in competition for light, nutrients, etc. It is difficult to take measurements within the *Azolla* canopy because of the smallness of *Azolla*, but it is not impossible. Competition can be measured indirectly through RGR. Further research could help optimize productivity of biomass and accumulated N if more information was available about intracrop competition.

Daylength is another important aspect of light. Growth rate has been shown to positively correlate to daylength (28) and continues to increase up to continuous illumination (37). Higher latitudes, such as central China, will have a longer daylength during the late spring and early summer *Azolla*-growing season than the tropics which have an almost uniform daylength all year-round. *Azolla* growth rate is higher in higher latitudes than in the tropics.

Temperature. Temperature is probably the most important limiting environmental factor in *Azolla* cultivation. It also is very difficult to manipulate. Its direct effects are not as serious as its indirect influences. For example, certain *Azolla* varieties can grow at temperatures of 40 °C or higher (22, 49) and some management practices can prevent paddy water temperatures from exceeding 40 °C in most cases if water is available.

The most serious problem with temperature is its stimulating effect on *Azolla* pests, e.g., insects, pathogenic fungi, and free-living algae. The optimum temperature for most *Azolla* species is within the range of 20-35 °C. At higher temperatures in this range and above, the generation time for

insects (57) and the growth rate of fungi greatly increase. Insects, particularly lepidoptera (32) and diptera (43), can destroy an *Azolla* crop if pesticides such as carbofuran or BHC are not used (30). Often, insects will sample a small part of a plant and then move on to another. The resulting injury makes the plant highly susceptible to various fungi which attack *Azolla* (1, 41, 45) and can greatly magnify the insect damage under hot-humid conditions.

Because high temperatures are not a direct limitation, *Azolla* has an excellent potential for successful cultivation in irrigated deserts where humidity is relatively low and alternate host plants for insects are limited. *Azolla* does very well on the northern border of Senegal in West Africa (Van Hove, pers. comm.) and can probably do well in the traditional rice areas of Mali with good water control.

Mineral nutrition. Because *Azolla* is an aquatic plant, essential elements must be available in the water for *Azolla* to survive. *Azolla* requires all essential plant elements plus Mo or Co for N fixation (4, 29, 51). However, most paddy water does not contain an adequate balance of essential elements for successful *Azolla* cultivation.

Phosphorus has been the most common limiting element for *Azolla* growth (31). The threshold concentration of P in *Azolla* tissue is probably about 0.2-0.3% on a dry wt basis (42; Sombath Somphone, pers. comm.). P stressed plants are usually smaller, pink to red, less vigorous, and have a low concentration of total N. Under severe stress, the plants become highly compact and dark red, and often develop very long curled roots.

P deficiency can be overcome by applying P fertilizer. Highly soluble forms such as triple superphosphate or phosphoric acid are effective. In some situations, deficient plants may be able to extract sufficient P from the paddy soil if the water level can be reduced to the point where *Azolla* roots can touch the soil.

Perhaps the most efficient way to use P fertilizer is to take advantage of *Azolla's* ability to use up P luxuriously. *Azolla* requires a minimum concentration of about 0.2-0.3% P on a dry wt basis for a normal N concentration of 3.0-4.0%. This equals a N:P weight ratio of 10-20 N for each P. Thus, 1 unit of P as fertilizer could result in 10-20 units of plant N at 100% uptake efficiency. But 100% uptake efficiency is impossible in the field because of losses of P from fixation, leaching, runoff, erosion, etc. Uptake efficiency can be significantly improved by preloading *Azolla* in phosphorus-rich nursery beds. Preloaded *Azolla* should be able to accumulate P up to its maximum luxury consumption level of 1.0-1.6% (30). After preloading, the plants can be placed in P-deficient fields for further multiplication. Even if no P is available in the paddy water, the *Azolla* plants should be able to increase their biomass 3-8 times (1.0/0.3 to 1.6/0.2) on stored P before reaching their threshold level for P. Plants should not be allowed to drop below the threshold level of P or their N yield will be reduced.

Other essential elements have been reported to be absent in paddy water. Applications of K have been found to be necessary on light soils in Vietnam and China (24, 25, 46). Liu et al (23) compared the K absorption ability of

Azolla and rice. They believe that *Azolla* is more efficient at K uptake and can be a K source for rice in K-deficient soils.

Some micronutrients have been reported to be deficient in paddy water. Adding small amounts of Mo salts stimulated growth in paddy fields in Korea and Vietnam (19, 46). Fe was reported to be deficient in California (39) and Australia (34). Adding 1.5 kg Fe/ha eliminated the deficiency in California.

Nitrogen can also be necessary to maintain *Azolla* under stressed conditions. Zhang (54) and Chen and Li (6) found that N fertilizer along with P and K were effective in maintaining *Azolla* during summer. Zhang and others (16, 20, 36, 53) found that combined N can adversely affect *Azolla* under good growing conditions. This adverse effect probably results from the beneficial effect of combined N on nonnitrogen-fixing organisms which compete with *Azolla*, such as weeds and algae.

Water quality. Several other aspects of water quality have been studied. Pollution from sewage (40) and herbicides (30) is of little concern to developing countries, but may be important as *Azolla* cultivation is attempted. Other factors are known to limit *Azolla* use. pH is perhaps the most important in developing countries. Optimum growth of *Azolla* in culture solution is in pH range of 4.5-7, but *Azolla* can survive in pH 3.5-10 (2, 35, 37, 50) if all essential elements are available.

The most important concern about pH is the availability of essential elements in the paddy water. The pH of most acid and alkaline soils changes toward a range of 6-7 a few weeks after flooding (38). However, some acid soils — acid sulfate and Histosols — which are low in organic matter or active Fe or high in sulfate, may not reach a pH of 6.0 even after months of submergence (8). These acid soils can create toxic levels of Al and Fe, and P deficiencies in the paddy water. Saline soils often have a pH greater than 7 and may be deficient in P, Zn, and Cu.

Chinese researchers (9, 17) recommended that water for *Azolla* cultivation should contain no more than 0.3% salt. Higher salt concentrations decreased plant N (9), and more salt increased plant N (17). Haller et al (11) found that *A. caroliniana* growth ceased when the concentration reached 1.3%. Salinity or alkalinity may be a problem in ricefields located along the coast (55) and in poorly drained irrigated deserts, such as in areas of Pakistan (5).

CONCLUSIONS

Azolla can be found throughout the world growing under a wide range of environmental conditions. However, conditions for survival in nature can be much more variable than those necessary for successful field cultivation, where growth rate and N accumulation are important. In China and Vietnam, wide-scale field cultivation normally occurs during winter and spring when conditions are cool and wet. *Azolla* cultivation is rarely attempted during hot-humid conditions because 1) more important crops occupy the paddy

fields, 2) insects and diseases are very difficult to control, and 3) paddy water must be managed to prevent temperatures of 45°C or higher. These same problems exist in the tropics and are often compounded by monsoon weather of extreme wet and dry seasons.

The following questions about cultivation should be considered before *Azolla* is recommended to farmers:

- Does the cropping system allow the growing of *Azolla* as a monocrop or intercrop, and is water readily available?
- How can some *Azolla* be maintained during off-season and how can it be multiplied and distributed before large-scale field cultivation?
- Is the water rich in essential plant elements, especially P, to support rapid growth of *Azolla*?
- Is the water neutral to mildly acidic in pH and does it contain less than 0.3% salt?
- Will it be necessary to frequently use pesticides for insect control? and
- Will *Azolla* cultivation improve the economic situation of the farmer?

REFERENCES CITED

1. Arunyanart, P., A. Surin, W. Rochanahasadin, and S. Disthaporn. 1983. Fungi-caused rotten diseases of *Azolla*. *Int. Rice. Res. Newsl.* 8(5):23.
2. Ashton, P. J. 1974. The effects of some environmental factors on the growth of *Azolla filiculoides* Lam. Pages 123-138 in *The Orange River progress report*. Inst. Environ. Sci., University Orange Free State, Bloemfontein, South Africa.
3. Basavana Gowd, R.M., K. Lakshmi pathy, C.K. Subramanian, and M.A. Srinivasan. 1980. *Azolla* can be grown in sunlight with soil pH range of 5.3 to 6.4 around Bangalore. *Curr. Res.* 9(3):40-41.
4. Becking, J.H. 1979. Environmental requirements of *Azolla* for use in tropical production. Pages 345-374 in *Nitrogen and rice*. International Rice Research Institute, P.O. Box 933, Manila, Philippines.
5. Beri, V., O.P., Meelu, and B. Raj. 1983. Multiplication of *Azolla* in alkaline soils of Punjab. *Int. Rice Res. Newsl.* 8(5):24.
6. Chen, J.M., and S.L. Li. 1980. Effect of mineral nutrition on the growth of *Azolla*. *Acta Pedol. Sin.* 17(4):390-394.
7. Dao, T.T., and Q.T. Tran. 1979. Use of *azolla* in rice production in Vietnam. Pages 395-405 in *Nitrogen and rice*. International Rice Research Institute, P.O. Box 933, Manila, Philippines.
8. De Datta, S.K. 1981. Principles and practices of rice production. John Wiley and Sons, New York.
9. Ge, S.A., Z.L. Xu, and Z.H. Shen. 1980. Salt tolerance of *Azolla* and the effects of its culture in the new reclaiming coast saline rice soils. *Zhejiang Nongye Kexue* 1:17-20.
10. Godard, P. 1982. Analyse des courbes de croissance et d'activite nitrogenasique d'*Azolla pinnata* en vue d'optimiser sa culture comme de Licencie en Sciences. Universite Catholique de Louvain, Louvain-la-neuve, Belgium.
11. Haller, W.T., D.L. Sutton, and W.C. Barlowe. 1974. Effects of salinity on the growth of several aquatic macrophytes. *Ecology* 55:891-894.
12. Hunan Academy of Agricultural Science. 1981. A study on the laws concerning the annual yield of *Azolla filiculoides* spores. *Hunan Nongye Kexue* 3: 19-20.
13. Hunan Academy of Agricultural Science. 1981. Nutrient requirement of *Azolla filiculoides* and the technique for mass cultivation from spores. *Hunan Nongye Kexue* 4:22-25.
14. Hunan Academy of Agricultural Science. 1982. A study on the bumper yield of *Azolla filiculoides* spores and their purification. *Hunan Nongye Kexue* 3:30-33.

15. International Rice Research Institute. 1979. Nitrogen and rice. P.O. Box 933, Manila, Philippines, 500 p.
16. Ito, O., and I. Watanabe. 1983. The relationship between combined nitrogen uptakes and nitrogen fixation in *Azolla-Anabaena* symbiosis. *New Phytol.* 95(4):647-654.
17. Jiangsu Co-op Study Group. 1983. A preliminary study on the improvement of heavy saline soils by the cultivation of *Azolla filiculoides*. *Jiangsu Nongye Kexue* 11:34-38.
18. Ke, Y.S., Z.T. Zhang, X.L. Liu, and D.Q. Ling. 1981. The collection and storage of *Azolla filiculoides* sporocarps. *Guangdong Nongye Kexue* 3:29-31
19. Kim, J.K., and H.K. Kim. 1967. The effects of physical and chemical factors on the growth of *Azolla* and *Anabaena*. *Nongop Kwahakwon Hakbro* (North Korea) 5:12-17.
20. Lee, C.C., C.J. Lin, and C.F. Lin. 1982. The use of *Azolla pinnata* in rice paddies. 2. The influences of soil and chemical fertilizers on the growth of *Azolla*. *J. Agric. Res. China* 31(3):225-234.
21. Li, Z.X., S.X. Zu, M.F. Mao, and T.A. Lumpkin. 1982. Studies on the utilization of eight *Azolla* species in agriculture. I. An investigation of their utilization properties [in Chinese, English summary]. *Sci. Agric. Sin.* 2:72-77.
22. Lin, C. 1979. The relationship of Red *Azolla* with the environment. *Turang Feiliao* 3:36-40.
23. Liu, G., W. Wei, G. Zhin, B. Weng, and Y. Zhang. 1982. Study on the potassium enriching physiology of *Azolla*. *Sci. Agric. Sin.* 4:82-87.
24. Lu, S.Y., K.Z. Chen, Z.H. Shen, and S.A. Ge. 1963. Rice paddy green manure: studies on the biological characteristics of Red *Azolla*. *Sci. Agric. Sin.* 11:35-40.
25. Lu, S.Y., Z.B. Zhou, and K.Z. Chen. 1966. Effects of phosphoric fertilizers on increasing the multiplication of Red *Azolla* and on the nitrogen fixation. *Turang Tongbao* 2:7-9.
26. Lumpkin, T.A. 1984. Assessing the potential for *Azolla* use in the humid tropics. *Int. Rice Comm. Newsl.* 33(1):30-33.
27. Lumpkin, T.A. 1985. Advances in Chinese research on *Azolla*. Pages 161-167 in *Royal Soc.. of Edinburgh, Proceedings*.
28. Lumpkin, T.A., and D.P. Bartholomew. 1986. Predictive models for the growth response of eight *Azolla* accessions to climatic variables. *Crop Sci.* 26: 107-111.
29. Lumpkin, T.A., and D.L. Plucknett. 1980. *Azolla*: botany, physiology, and use of a green manure. *Econ. Bot.* 34(2):111-153.
30. Lumpkin, T.A., and D.L. Plucknett. 1982. *Azolla* as a green manure: use and management in crop production. Westview Press, Boulder, Colorado. 230 p.
31. Ma, J.Y., and G.M. Xu. 1962. The cultivation of *Azolla* in the ricefields using phosphate to increase nitrogen. *Zhongguo Nonabao* 6:13-16.
32. Mochida, O., Y. Yoshiyasu, and D. Dimaano. 1987. Insect pests of *Azolla* in the Philippines. Pages 207-221 in *Azolla utilization*. International Rice Research Institute. P.O. Box 933, Manila, Philippines.
33. Moore, A.W. 1969. *Azolla*: biology and agronomic significance. *Bot. Rev.* 35:17-35.
34. Muirhead, W.A., and F.M. Melhuish. 1983. Growth of *Azolla* in ricebays. Pages 92-93 in *CSIRO Division of Irrigation Research, 1981-82 Report*, Australia.
35. Nickell, L.G. 1961. Physiological studies with *Azolla* under aseptic conditions. II. Nutritional studies and the effects of chemicals on growth. *Phyton* 17:49-54.
36. Oes, A. 1913. *Über die assimilation des freien stickstoffs durch Azolla*. *Z. Bot.* 5:145-163.
37. Peters, G.A., R.E. Toia Jr., W.R. Evans, D.K. Crist, B.C. Mayne, and R.E. Poole. 1980. Characterization and comparisons of five N₂-fixing *Azolla-Anabaena* associations. I. Optimization of growth conditions for biomass increase and N content in a controlled environment. *Plant Cell Environ.* 3:261-269.
38. Ponnampetuma, F.N. 1972. The chemistry of submerged soils. *Adv. Agron.* 24:29-96.
39. Rains, D.W., and S.N. Talley. 1979. Uses of *Azolla* in North America. Pages 417-431 in *Nitrogen and rice*. International Rice Research Institute, P.O. Box 933, Manila, Philippines.
40. Scharpenseel, H.W., K.H. Menke, D. Goetz, H. Meyer-Spasche, and K. Doerfeling. 1982. Culture, composition, and utilization of the nitrogen-collecting *Azolla Anabaena*, sp. *filiculoides* system in nutrient solutions and diluted sewage solutions. *Landwirtsch. Forsch.* 35(3/4):200-213.
41. Shahjahan, A.D.M., S.A. Miah, M.A. Nahar, and M.A. Majid. 1980. Fungi attack *Azolla* in Bangladesh. *Int. Rice Res. Newsl.* 5(1):17-19.

42. Subudhi, B.P.R., and I. Watanabe. 1981. Differential phosphorus requirements of *Azolla* species and strains in phosphorus-limited continuous culture. *Soil Sci. Plant Nutr.* 27(2):237-247.
43. Takara, J. 1981. Insect pests and their relative abundance on *Azolla pinnata* R. Br. at Bangkhen, Thailand. *Int. Rice Res. Newsl.* 6(4):12-13.
44. Talleky, S.N., and D.W. Rains. 1980. *Azolla filiculoides* Lam. as a fallow-season manure for rice in a temperate climate. *Agron. J.* 72(1):11-18.
45. Ventataraman, S., and S. Kannaiyan. 1984. Influence of phosphorus and pyrite on *Azolla* growth. *Int. Rice Res. Newsl.* 9(3):24.
46. Vo, M.K., and Q.T. Tran. 1970. Beo Hoa Dau (*Azolla*). *Nha Xuat Ban Nong Than*, Hanoi. 174 p.
47. Wang, Q.P., J. Chen, and M.H. Wu. 1981. Techniques for oversummering *Azolla filiculoides* and mass cultivation of spores. *Fujian Nongye Keji* 3:21-22.
48. Watanabe, I. 1984. Use of symbiotic and free-living blue-green algae in rice culture. *Outlook Agric.* 13(4):166-172.
49. Watanabe, I., and N.S. Berja. 1983. The growth of four species of *Azolla* as affected by temperature. *Aquat. Bot.* 15(2):175-185.
50. Watanabe, I., N.S. Berja, and V.B. Alimagno. 1977. Utilization of the *Azolla-Anabaena* complex as a nitrogen fertilizer for rice. *IRRI Res. Pap. Ser.* 11. 15 p.
51. Yatazawa, M., N. Tomomatsu, N. Hosoda, and K. Nunome. 1980. Nitrogen fixation in *Azolla-Anabaena* symbiosis as affected by mineral nutrient status. *Soil Sci. Plant Nutr.* 26(3):415-426.
52. Yu, L.H. 1982. A study of techniques and effects of oversummering of *Azolla filiculoides* under damp conditions. *Zhejiang Nongye Kexue* 4:201-206.
53. You, C.B., J.W. Li, W. Song, and W.X. Wei. 1982. Effect of nitrogen sources on some physiological characteristics of *Azolla*. Pages 719-725 in *Proceedings symposium on paddy soils*, Nanjing, 1980. John Wiley and Sons, New York.
54. Zhang, W.M. 1982. The effect of nitrogen, phosphorus, and potassium fertilizers on the growth of three species of *Azolla*. *Zhejiang Nongye Kexue* 4:191-194.
55. Zhang, D.H., and H. Wu. 1981. Observation of tolerance of *Azolla* to saline-alkali soil. *Jiangsu Nongye Kexue* 5:59-60.
56. Zhejiang Co-op Study Group. 1982. A study of techniques for the production of *Azolla filiculoides* seedlings from spores. *Zhejiang Nongye Kexue* 4:185-190.
57. Zhu, Z.L., and S.F. Jan. 1982. Investigation on the rules governing the incidence of *Pyralis* sp. and *Nymphula enixalis*, estimation and utilization of the effective accumulated temperature. *Sci. Agric. Sin.* 4:74-81.

DISCUSSION

CRASWELL: Are data available on the total area of *Azolla* used in farmer fields in various rice-growing countries? If not, some effort should be made to collect such data so that the trends in *Azolla* use in various countries can be monitored.

LUMPKIN: I have not seen precise data on the area of *Azolla* cultivation in any country. Reports from both China and Vietnam are highly variable. Perhaps remote sensing could be used for regions where *Azolla* use is concentrated.

MOCHIDA: Is it possible to use *Azolla* as feed for snails, which are used as food of humans? How shall we resolve the schistosomiasis disease where *Azolla* is used in rice fields, for example, in Leyte or South Cotabato, in the Philippines? Do you have any comments?

LUMPKIN: I have not seen any literature reporting the acceptability of *Azolla* to snails which are used as human food. Perhaps a coordinated snail eradication program with clonitralide could be effective. A concentration of 0.5 ppm in paddy water solution has been reported to be effective. All efforts should be used to eliminate detrimental environmental consequences of such a program.

DE WAHA: What method do you use to establish equations permitting correlation between productivity and climatic data?

LUMPKIN: We use a main frame computer software called SAS. Within SAS we use SYSREG and STEPWISE programs.

**USE OF *AZOLLA*
IN VARIOUS REGIONS**

The *Azolla* program of the Philippines

B.B. MABBAYAD

Department of Agronomy

University of the Philippines at Los Baños

College, Laguna, Philippines

The rising cost of fossil fuel-based N fertilizers and the immense need to increase food supply prompted the Philippines to launch a research-oriented National *Azolla* Action Program (NAAP) and an extension-oriented Unified *Azolla* Program (UAP). The program is to reduce rice farmers' dependence on inorganic N fertilizers by promoting the use of *Azolla* for wetland rice. The strategy involved establishment of a National Inoculum Center (NIC) at the University of the Philippines at Los Baños (UPLB) and subcenters in selected agricultural institutions; establishment of Regional Propagation Centers (RPCs), Provincial Propagation Centers (PPCs), and Community nurseries; and manpower training and an extension campaign. Experimental results indicate the potential of *Azolla* as an alternative source of N for rice and as an animal feed. Much remains to be done in the promotion of *Azolla* use. Technical constraints identified are: uncertainty of water supply, insects and diseases, high temperature, inadequate P level, and dispersal of sporophyte materials.

THE NATIONAL *AZOLLA* PROGRAM

The University of the Philippines at Los Baños (UPLB) and the Ministry of Agriculture and Food (MAF) in July 1982 launched a research and extension *Azolla* Program. The program was designed primarily to promote the utilization of *Azolla* as an alternative source of N for wetland irrigated rice culture.

The National *Azolla* Action Program (NAAP) has two broad objectives:

1. To reduce by 50% inorganic N fertilizer use in wetland irrigated rice areas suitable for *Azolla* culture; and
2. To reduce the dependence of rice farmers on inorganic N fertilizers.

To achieve the goals of the program, four major thrusts were considered crucial:

1. establishment of a National Inoculum Center (NIC) at UPLB and subcenters in selected agricultural institutions (Fig. 1). The center and subcenters serve as sources of pure inoculum of superior *Azolla* strains. They also conduct short-term research in support of the Action Program;

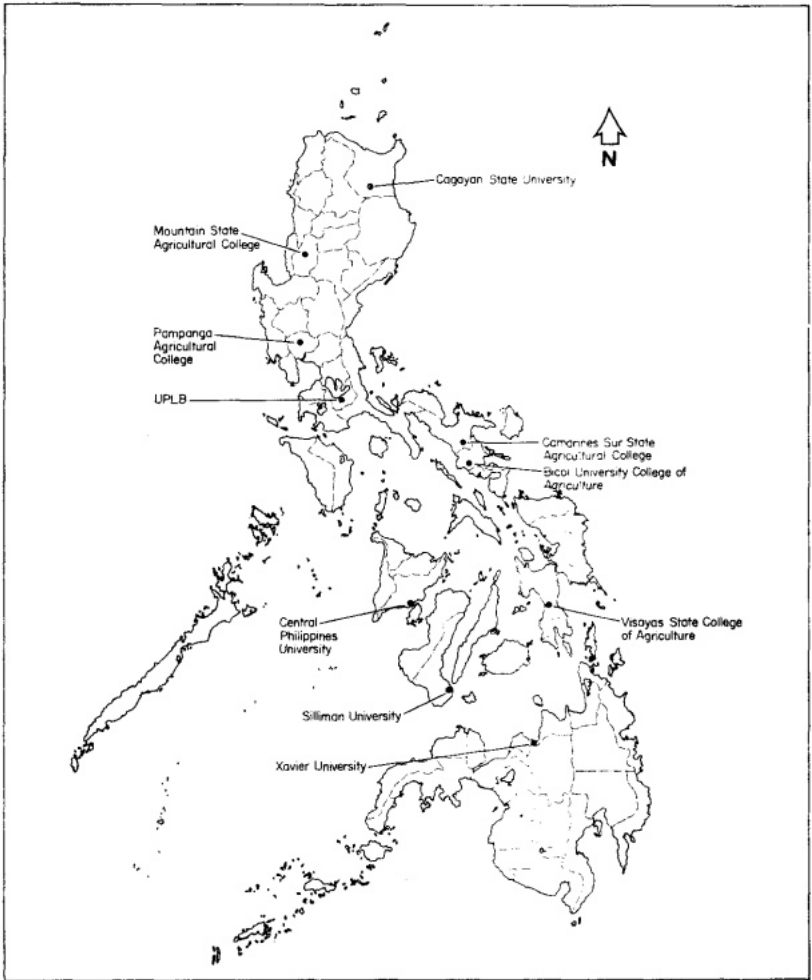

1. The National Inoculum Center (UPLB) and subcenters in the Philippines.

2. establishment of Regional Propagation Centers (RPCs) in the 12 administrative regions of the country to serve as initial sources of inoculum for distribution to provincial and community nurseries;
3. preparation of an area operation plan for each region to identify, classify, and prioritize wetland rice growing areas suitable for *Azolla* growth; and
4. training and the production of information and extension materials.

Strengthening the *Azolla* Extension Program

To accelerate the utilization of *Azolla* as a green manure for wetland rice, an extension program on *Azolla* was created in July 1984. The program is administered and implemented directly by the MAF. Initially, the program

aims to operate a minimum of 68 provincial propagation centers and 3,000 community nurseries to meet the inoculum requirements of a target area of 300,000 ha under the Masagana 99 rice program (7).

Redirection of the National *Azolla* Action Program

With the creation of the *Azolla* extension program, the activities of the NAAP were realigned, emphasizing:

- conduct of short-term research in support of the extension program;
- preparation of prototype communication materials and training modules, and conducting training for trainers; and
- technology packaging and technology performance evaluation.

For better coordination of both programs, NIC researchers and scientists are members of the various working committees of the *Azolla* extension program.

STATUS OF THE PROGRAM

Action and extension program

These are the achievements made since the program started in 1982:

1. The MAF has established 12 RPCs (Fig. 2).
2. Twelve teams of 4 persons each from the 12 MAF regional offices were trained at the NIC (5).
3. Technicians and farmers were trained by MAF personnel in the various regions of the country.
4. Based on the MAF report of Region XI, 6,500 ha of wetland rice in South Cotabato, Philippines, now utilize *Azolla* as a green manure.

Research program

Current NAAP research aims to solve immediate problems encountered in the Action Program. Research activities of the NIC and subcenters focus on biology and culture, *Azolla* utilization, and economics of *Azolla* use. Some experimental results are summarized below.

Sporulation and biomass production. NAAP researchers and scientists are studying *Azolla* dispersal by spores. Based on the results, 22 strains of *Azolla* were sporulated in the greenhouse in La Trinidad, Benguet (6). Intensity of sporulation (sporulation index) ranged from 5 to 100%. In the field, 5 strains were sporulated from September to March with sporulation index ranging from 17 to 85%.

Preliminary tests conducted by the NAAP Biology and Cultural research team showed that *A. microphylla* 418 reproduced sexually for 119 d producing 1 sporophyte daily. Another strain, *A. caroliniana* 302, reproduced sexually for 92 d producing 1 sporophyte daily. This test used dried sporulating *Azolla* materials grown in the greenhouse. These findings underscore the possibility of developing improved strains suited to the environments in the country.

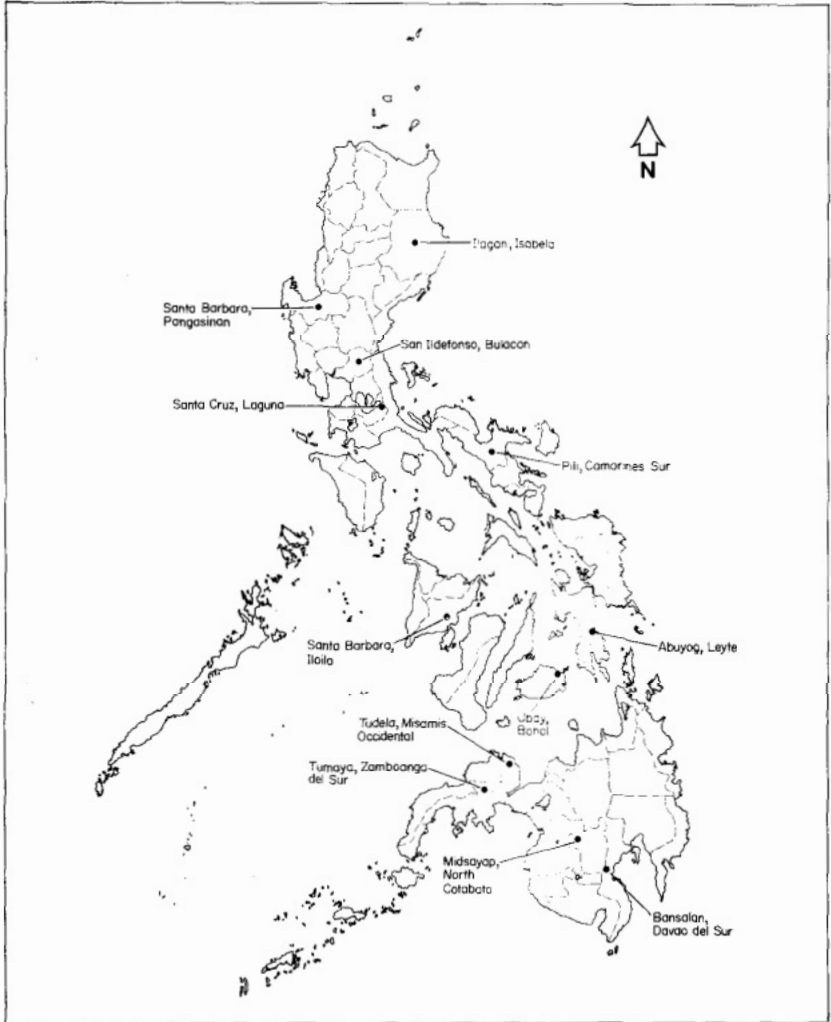

2. Regional propagation centers in the Philippines.

Studies on biomass production showed that the average net production of four strains [*A. microphylla* 417, *A. caroliانا*, *A. pinnata* (Bangkok), and *A. pinnata* (Australia)] was low during the hot months (Apr-May). Figure 3 shows the fluctuation of biomass production during the year in Los Baños, (4, unpubl.). Among the strains tested, *A. microphylla* produced the highest net biomass, averaging 1.2 kg/m^2 per wk from Sep to Mar and 0.85 kg/m^2 per wk from Apr to Aug.

As green manure. Some studies on the utilization of *Azolla* as a green manure for wetland rice have been conducted. In field trials in six successive croppings, *Azolla* applied as a green manure could supply at least half of the N

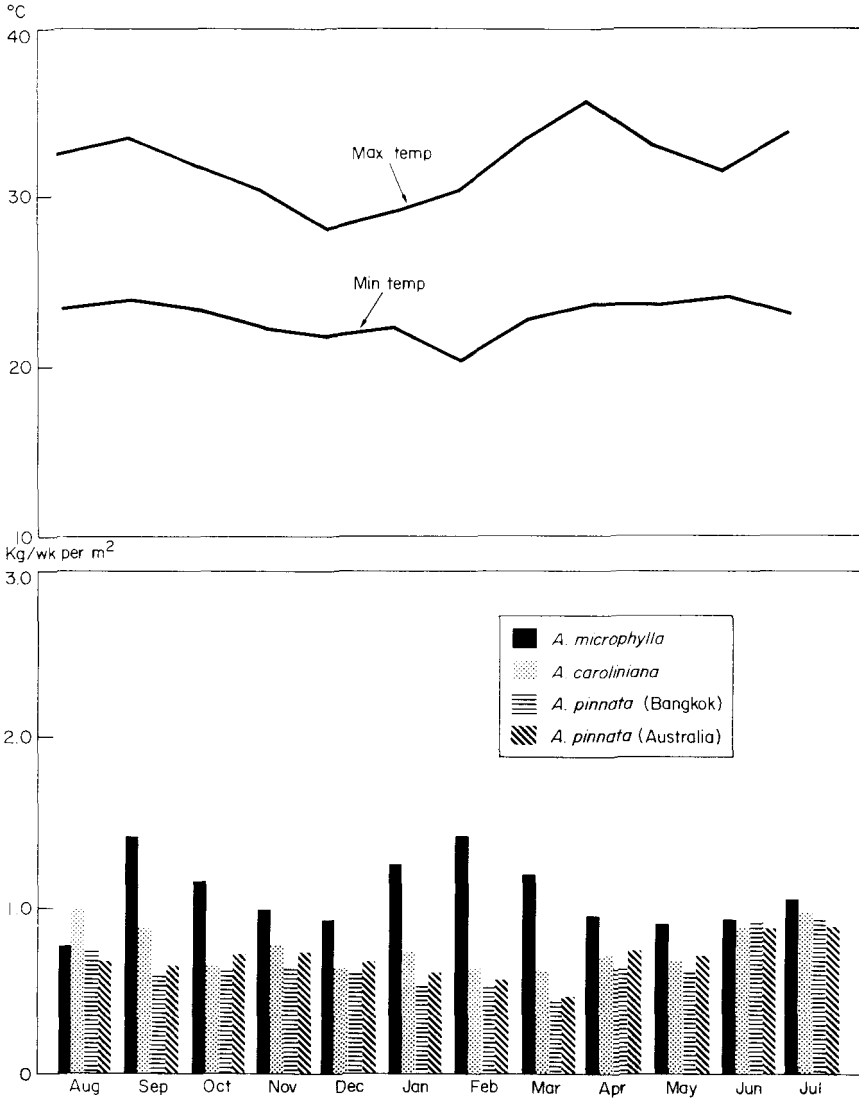

3. Net biomass production of 4 strains of *Azolla*, Los Baños, Laguna, Philippines. Source: (4). Experimental condition: pH - 6.4; available P (Brav No. 2) - 16.1 ppm; pond size - 84 m² with sampling area of 2 m² for each strain. Water depth maintained at 10 cm and free flowing. Phosphorus applied every 2 wk at 1 kg ai/ha.

requirement for rice (Table 1). On the average, *Azolla* biomass (1.5 kg/m²) incorporated 27 d after transplanting (DT) can supply about 31.2 kg N/ha.

Boonjung (3) showed that *Azolla* may reduce applied N loss from the floodwater (Table 2). Plots inoculated with *Azolla* soon after basal application of 60 kg N/ha, either incorporated (T₇) or unincorporated (T₅), gave higher

Table 1. Grain yield of transplanted rice as affected by different combinations of *Azolla* and inorganic N application, UPLB, 1982-55.

Treatment ^a	Grain yield (t/ha)						Mean
	First crop	Second crop	Third crop	Fourth crop	Fifth crop	Sixth crop	
1	4.59	4.72	4.80	4.26	5.24	3.36	4.49
2	4.59	4.41	4.25	4.09	4.72	3.84	4.37
3	4.58	3.81	4.20	4.17	4.18	3.76	4.12
4	3.92	3.64	4.60	3.30	4.24	3.44	3.86

Variety used: UPLRi-4 (1st and 2d crops), IR36 (3d, 4th, and 5th crops), IR60 (6th crop). ^a Treatment 1, 90-30-30 (- *Azolla*); 2, 45-30-30 (+ *Azolla* incorporated at 27 DT); 3, 0-30-30 (+ *Azolla* incorporated at 1 DBT), 4, 0-30-30 (+ *Azolla* incorporated at 27 DT). DBT = days before transplanting, DT = days after transplanting. Source: (4).

Table 2. Grain yield of IR58 as affected by *Azolla* and inorganic N application. 1984 dry season, UPLB, Philippines.

Treatment	Yield ^a (t/ha)
T ₁ Control (no N and <i>Azolla</i>)	2.2 g
T ₂ <i>Azolla</i> topdressed (incorporated)	2.7 f
T ₃ <i>Azolla</i> topdressed (unincorporated)	2.5 fg
T ₄ 60 kg N/ha	3.9 bcd
T ₅ T ₃ + T ₄	4.5 a
T ₆ 60 kg N/ha (BI)	3.6 bcd
T ₇ T ₃ + T ₆	4.7 a
T ₈ 60 kg N/ha (10 DT)	3.2 e
T ₉ T ₃ + T ₈	3.9 Bcd
T ₁₀ 30 kg N/ha (BU) + 30 kg N/ha (PI)	3.7 cde
T ₁₁ T ₃ + T ₁₀	4.4 ab
T ₁₂ 30 kg N/ha (BI) + 30 kg N/ha (PI)	4.0 bcd
T ₁₃ T ₃ + T ₁₂	4.3 ab
T ₁₄ 60 kg N/ha (PI)	3.5 de
T ₁₅ T ₃ + T ₁₄	4.2 abc

^a Means followed by a common letter on a column are not significantly different at 5% level using DMRT. BU = basal application 1 d before transplanting and unincorporated, BI = basal application 1 d before transplanting and incorporated, PI = topdressed at panicle initiation, DT = days after transplanting. Source: Boonjung and Mabbayad, unpubl. data.

yield than topdressing with 60 kg N/ha (T₁₀ and T₁₂) and topdressing with 60 kg N/ha at panicle initiation (T₁₄). This could be due to reduced ammonia volatilization from the floodwater as a result of lower windspeed at the floodwater surface. At low windspeed, gas phase resistance dominates and reduces ammonia volatilization. The other reason may be the reduction of algal growth through competition with the developing cover of *Azolla*, which depressed the increase of midday pH (8) and consequently ammonia loss (Fig. 4).

Animal feed. The potential of *Azolla* as an animal feed has been studied. Preliminary tests showed that *Azolla* meal can be used up to 10% in swine starter ration, 20% in swine grower ration, and 15% in broiler ration without significantly affecting the performance of the test animals (1).

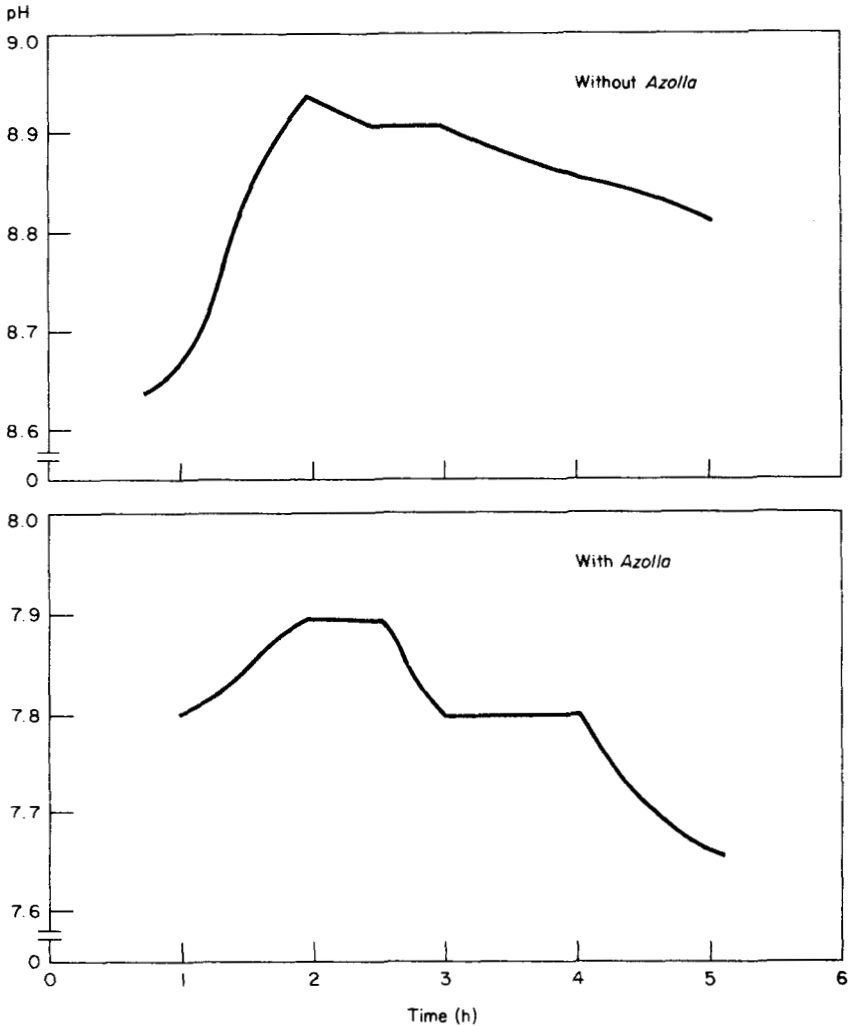

4. Changes in pH of pond water at different times with and without *Azolla* cover. Source: (8).

Egg production and egg size were not significantly affected when fresh *Azolla* was fed to mallard ducks up to 20% of the feed ration (2).

PROSPECTS AND PROBLEMS

Much remains to be done in promoting *Azolla* use in tropical rice production. Some of the technical constraints are uncertainty of water supply, insects and diseases, high temperature, P level, acidity, salinity, and dispersal and handling of the materials. Research is directed toward solutions to these problems.

REFERENCES CITED

1. Alcantara, P.F., and L. Querubin. 1985. Feeding value of Azolla meal for poultry and swine. Paper presented during the Agricultural Policy Workshop on organic and inorganic fertilizer, 18 January 1985, University of the Philippines at Los Baños, Philippines. 12 p.
2. Alejar, A.S., B.B. Mabbayad, and R.P. Escobin. 1984. Rice-duck integrated farming system, Mimeographed progress report. 11 p.
3. Boonjung, H. 1984. *Azolla* as fertilizer and weed suppressant for transplanted rice. MS thesis, University of the Philippines at Los Baños, Philippines.
4. Mabbayad, B.B., S.O. Batalon, and M.A. Lapitan. 1984. Biomass production of four strains of *Azolla* at Los Baños, Philippines. Mimeographed progress report. 8 p.
5. National Azolla Action Program. 1984. National *Azolla* Action Program executive summary annual report, 1984. 6 p.
6. Payawal, P.C. 1985. The water fern *Azolla*: its biology and culture. Paper presented during the Agricultural Policy Workshop on Organic and Inorganic Fertilizer, 18 January 1985, University of the Philippines at Los Baños, Philippines. 2 p.
7. Quebral, F.C. 1985. *Azolla* program of the Philippines. Paper presented during the Agricultural Policy Workshop on Organic and Inorganic Fertilizer, 18 January 1985, University of the Philippines at Los Baños, Philippines. 2 p.
8. Villegas, G.G. 1985. The effect of *Azolla* on nitrogen in lowland soils planted to rice. MS thesis, University of the Philippines at Los Baños, Philippines.

DISCUSSION

ESKEW: You mentioned that *Azolla* use has been adopted on 84,000 ha in the Philippines. What is the percentage yield increase observed in farmers' fields?

MABBAYAD: There are no data available at the moment. However, our data from field experiments indicated that yield obtained from plots fertilized with 90 kg N/ha was comparable to those from plots fertilized with half as much N plus *Azolla* applied basally and at 21 DT.

HU: From your data, it appears that topdressing and incorporating do not differ much. Does topdressing with *Azolla* seem more feasible because of labor savings?

MABBAYAD: Our data indicate that topdressing without incorporation is as good as topdressing with incorporation. I do not know the exact reasons for that. It is difficult to separate the effect on weed control from the effect of *Azolla* as a nutrient source per se.

DIARA: Did you experience insect attacks and, if so, what were your control measures?

MABBAYAD: Yes. We controlled them with monocrotophos or carbofuran. Webworm and caseworm occur sporadically.

Use of *Azolla* in India

S. KANNAIYAN

Department of Agriculture Microbiology

Tamil Nadu Agricultural University

Coimbatore 641 003

Tamil Nadu, India

Seem cake *Azadirachta indica* stimulated the growth and nitrogenase activity of *Azolla*, and stimulated the activity of the ammonia-assimilating enzyme GDH, although it suppressed the activity of the enzymes GOGAT and GS at higher concentrations. Butachlor applied as a spray to *Azolla* and urea at 25-50 ppm inhibited GDH, GS, and GOGAT activity. Growth reduction was also noted with the butachlor treatment. A nursery technique for large-scale production of *Azolla* in the field was developed using applications of fresh cattle dung and superphosphate. Fertilizer N along with *Azolla* inoculation as a dual crop at 200 g/m² increased rice yield of IR20. *Azolla* inoculation as a dual crop with split applications of P significantly increased rice grain yield. *Parthenium* applied at 10 t/ha and *Azolla* inoculation as a dual crop at 200 g/m² gave even higher yields. Highest yields were achieved with neem-coated prilled urea applied with *Azolla* inoculation. Neem-coated urea and urea supergranules increased N uptake in rice. Fertilizer N with *Azolla* and blue-green algae (BGA) inoculation increased grain yield. *Azolla* inoculum proportionately decreased weed growth and increased grain yield. Both *Sesbania* and *Colocasia* intercropped with *Azolla* in the summer support *Azolla* growth. Mud pots with soil extract solutions are suitable for maintaining *Azolla* in summer. Black rot disease of *Azolla* caused by *Rhizoctonia solani* was serious in *A. pinnata*, *A. nilotica* was highly susceptible, but *A. pinnata*, *A. caroliniana*, and *A. pinnata* (Bangkok) were tolerant. The systemic fungicide carbendazim applied at 50 ppm reduced disease severity. The granular insecticides aldicarb and carbofuran have a low level of residue accumulation in *Azolla*.

Azolla use for wetland rice culture is increasing in several rice growing regions in India. The introduction of high yielding rice varieties has revolutionized rice production technology. But the increasing cost of fertilizers, particularly nitrogen, and the widening gap between supply and demand of nitrogen in developing countries have placed heavy burden on farmers. Thus, N₂ fixation and conservation by *Azolla* would be an ideal biological system for increasing rice yield under low-cost rice production technology.

Biological nitrogen fixation through *Azolla-Anabaena* complex is considered a potential biological system for increasing rice yield at comparatively low cost. Watanabe et al (16) established the potential ability of *Azolla* N₂ fixation at about 1.1 kg N/ha per d.

Singh (14) recorded a 13-33% increase in yield over the control when 5-15 t *Azolla* fresh wt/ha was incorporated. Govindarajan et al (1) recorded a 13.5% yield increase over control when *Azolla* was dual cropped with IR20. The inoculation of *Azolla* at 2 t/ha as a dual crop yielded as much as 25 kg fertilizer N/ha (8). Mani et al (11) found that applying 30 kg N/ha with 5 t *Azolla* fresh wt/ha yielded as much as 60 kg N/ha. Kannaiyan et al (9) established positive rice crop response with *Azolla* inoculation at four sites—Coimbatore, Aliyarnagar, Ambasamudram, and Tirurkuppam. The effective utilization of *Azolla* for rice production in India is well documented (4, 14).

Azolla pinnata is commonly grown in India. *Azolla* production and utilization is popular among rice farmers in Tamil Nadu and Karnataka and *Azolla* technology is gaining importance in other states.

NITROGEN FIXATION

Effect of neem cake on nitrogen fixation

We conducted an in vitro experiment using neem cake at 25, 50, 100, 150, 200, 250, 500, 750, and 1000 ppm levels. Fresh wt of *Azolla* and nitrogenase activity were assessed on the 14th day. Increase in the concentration of neem cake significantly increased biomass yield of *Azolla*. Neem cake at all levels increased nitrogenase activity (Table 1). Kannaiyan et al (8) observed increased growth and low pest incidence in *Azolla* due to neem cake application. Neem cake stimulates *Azolla* by encouraging multiplication and nitrogenase activity, and combating insect pests and diseases of *Azolla*. In another experiment, neem cake applied to *Azolla* markedly stimulated glutamate dehydrogenase (GDH) activity at 200 and 250 kg/ha (Table 2).

Table 1. Effect of neem cake on the growth of and N₂ fixation in *Azolla*.

Neem cake (ppm)	Biomass (g/container)	Increase over control (%)	Nitrogenase activity (nmoles C ₂ N ₄ /g dry wt)
25	2.2	62.3	57.10
50	2.3	73.6	63.35
100	2.3	75.5	63.47
150	2.5	86.8	87.81
200	2.5	88.7	162.57
250	2.5	90.6	187.81
500	2.7	101.9	251.46
750	2.7	103.8	193.96
1000	3.0	122.6	170.87
Soil extract control	2.0	52.8	52.27
Water control	1.3		23.12

Table 2. Effect of neem cake on ammonia-assimilating enzymes of *Azolla*.

Neem cake (kg/ha)	Ammonia-assimilating enzyme per mg of protein		
	GDH	GOGAT	GS
Control	3.00	422	208
25	3.33	373	232
50	3.33	386	205
75	4.00	408	192
100	4.75	425	189
150	4.33	351	197
200	6.17	334	211
250	6.67	381	166

Table 3. Effect of fertilizer N (urea) on the growth and ammonia-assimilating enzymes of *Azolla*.

Urea (ppm)	Mean <i>Azolla</i> wt (g)	Decrease over control (%)	Ammonia-assimilating enzyme per mg of protein	
			GDH	GS
Control	2.4	—	6.26	220
5	2.3	- 2.1	6.21	211
10	2.3	- 3.0	6.15	202
15	2.2	- 6.4	6.06	200
20	2.2	- 8.5	6.20	208
25	2.0	-12.8	5.97	186
30	2.0	-14.9	5.97	184
35	2.0	-14.9	5.81	170
40	1.8	-25.5	5.72	162
45	1.5	-34.9	5.51	148
50	1.4	-39.6	5.22	131

Effect of fertilizer N on ammonia-assimilating enzymes

The influence of urea on the growth and ammonia-assimilating enzymes of *Azolla* was studied in a pot culture experiment with urea concentrations of 5, 10, 15, 20, 25, 30, 40, 45, and 50 ppm. The *Azolla* inoculation level was 2 g/pot. *Azolla* samples were drawn after 24 h and an enzyme extract was prepared to estimate the ammonia-assimilating enzymes. *Azolla* biomass yield was also recorded on the 10th day.

Ammonia-assimilating enzymes were not inhibited by fertilizer N up to the 20 ppm level, but inhibition was severe from the 25 to 50 ppm levels (Table 3). Glutamine synthetase (GS) activity was significantly more inhibited than GDH activity at higher levels of urea concentration.

Effect of butachlor on ammonia-assimilating enzymes

We conducted a pot experiment to determine the effect of butachlor on the growth and ammonia-assimilating enzymes of *Azolla*. Mud pots filled with 1 kg of ricefield soil and 4 liters of water were used. An initial inoculum level of *Azolla* at 15 g/pot was added. Butachlor 50% EC at 25, 50, 75, 100, 125, 150, 175, and 200 ppm concentrations was sprayed over the *Azolla* with a hand

Table 4. Effect of butachlor on growth and ammonia-assimilating enzymes of *Azolla*.

Butachlor (ppm)	Mean <i>Azolla</i> wt (g)	Decrease over control (%)	Ammonia-assimilating enzyme per mg of protein		
			GDH	GOGAT	GS
Control	23.0	—	4.94	412	235
25	22.5	-2.2	4.83	403	230
50	22.0	-4.4	4.81	386	225
75	21.0	-8.7	4.36	382	221
100	20.0	-13.0	4.20	380	214
125	18.0	-21.7	4.01	351	210
150	16.0	-30.4	3.79	325	202
175	14.0	-39.1	3.83	308	191
200	12.5	-45.6	3.05	302	180

sprayer. *Azolla* samples were drawn on the 3d day and ammonia-assimilating enzymes GDH, GS, and glutamate synthase (GOGAT) were estimated. *Azolla* biomass fresh wt was recorded on the 10th day after inoculation. *Azolla* growth decreased gradually with increased concentrations of butachlor. Reduction in *Azolla* growth was observed at higher doses of butachlor (Table 4). In general the ammonia-assimilating enzymes are considerably inhibited at higher concentrations.

AZOLLA AS BIOFERTILIZER

***Azolla* nursery**

Farmers can easily multiply *Azolla* in the field by following a simple nursery method. The field selected for the nursery is first thoroughly prepared and leveled. The field is divided into 20- × 2-m plots with bunds and irrigation canals, and the plots are flooded to a depth of 10 cm. Ten kg of fresh cattle dung mixed in 20 liters of water is sprinkled on each plot, which is then inoculated with 8 kg *Azolla* fresh wt. Superphosphate (100 g) is topdressed in 3 split doses at 4-d intervals. Furadan G at 100 g/plot is applied 7 d after inoculation for insect pest control. *Azolla* is harvested 15 d after inoculation and introduced into the main field as the primary source of inoculum. From 40 to 55 kg *Azolla* fresh wt is obtained from each plot. The *Azolla* nursery is grown while rice nursery is raised. Adding cow dung to the flooded rice soil system increases the growth of *Azolla* and nitrogenase activity (12). Cow dung and cattleshed water increased the growth of *Azolla* during winter (6).

***Azolla* manuring for rice**

Dual cropping *Azolla* with rice at 300 g/m² increased rice grain yield 26% (4). Fertilizer N and *Azolla* dual cropped at 200 g/m² with IR20 and incorporated once at tillering and again at maximum tillering increased grain yield significantly (Table 5). In another field study, *Azolla* applied as green manure and dual cropped was compared with locally available aquatic weeds and *Parthenium*. Applying *Parthenium* as green manure at 10 t/ha and dual

Table 5. Effect of *Azolla* on rice yield.

Nitrogen (kg/ha)	Grain yield (t/ha)	
	With <i>Azolla</i>	Without <i>Azolla</i>
0	4.4	3.9
25	4.7	4.6
50	4.9	4.8
75	5.2	4.9
100	5.6	5.4

Table 6. Comparative effect of *Azolla* and certain green manures on rice grain yield.

Treatment ^a	Grain yield (t/ha)	Increase over control (%)
Control	2.1	—
30 kg N/ha	2.4	14.6
<i>Azolla</i> (DC) as 200 g/m ²	3.2	47.9
<i>Azolla</i> (GM) at 10 t/ha	2.5	16.7
<i>Parthenium</i> (GM) at 10 t/ha	3.2	47.9
<i>Lemna</i> (GM) at 10 t/ha	2.4	14.6
Water hyacinth (GM) at 10 t/ha	2.5	18.8
<i>Ipomoea</i> (GM) at 10 t/ha	2.8	33.3
Rice straw at 10 t/ha	2.4	12.5

^aDC = dual crop, GM = green manure.

Table 7. Effect of different grades of urea and *Azolla* as a dual crop (DC) on rice grain yield.

Treatment ^a	Grain yield (t/ha)	Increase over control (%)
Control	2.0	—
<i>Azolla</i> DC	2.4	16.4
Prilled urea at 60 kg N/ha	3.0	50.6
Urea supergranules at 60 kg K/ha	3.1	53.2
Neem-coated urea at 60 kg K/ha	3.1	53.1
Prilled urea + <i>Azolla</i> DC	3.4	68.3
Urea supergranules + <i>Azolla</i> DC	3.3	62.0
Neem-coated urea + <i>Azolla</i> DC	3.6	79.7

^aDC = dual crop.

cropping *Azolla* gave higher yields (Table 6). *Parthenium* application gave maximum tiller production and panicle number followed by *Azolla* dual cropped.

Rice yield and N uptake by rice when dual cropped with *Azolla* in combination with different grades of urea (prilled, supergranules, and neem-coated) were compared. Neem-coated urea combined with *Azolla* gave the highest grain yield. Of the three forms of urea tested, urea supergranules and neem-coated urea gave highest grain yield (Table 7). A similar trend was noticed in grain filling, 1,000-grain wt, plant height, panicle number, tiller number, and N uptake.

Table 8. Effect of blue-green algae (BGA) and *Azolla* on rice grain yield.

Treatment	Grain yield (t/ha)			
	0 kg N/ha	50 kg N/ha	75 kg F/ha	100 kg N/ha
Uninoculated control	3.5	4.2	4.3	4.4
BGA	3.9	4.4	4.7	4.8
<i>Azolla</i>	3.9	4.3	4.6	4.6
BGA + <i>Azolla</i>	4.0	4.7	4.9	4.9

Table 9. Effect of *Azolla* inoculation on weed^a suppression in wetland rice.

<i>Azolla</i> inoculum (g/m ²)	Fresh weed Wt (kg/7.5-m ² plot)	Reduction over control (%)	Grain yield (t/ha)
100	2.9	46.9	6.0
150	2.6	51.5	6.3
200	1.8	66.9	6.2
250	2.1	61.6	6.0
300	2.2	60.3	6.2
350	1.9	65.8	6.1
400	1.4	74.3	6.0
450	1.0	80.9	6.5
500	1.3	76.3	6.6
30 kg N/ha alone	5.7	—	5.4
Uninoculated control	5.4	—	3.4

^a *Echinochloa glabrescens*, *E. colona*, *E. stagnina*, and *E. crus-galli*.

Combined inoculation of BGA and *Azolla* with fertilizer N significantly increased grain yield of CO-41 (Table 8).

Under tropical conditions in India, biologically fixed nitrogen from *Azolla* can be most effectively transferred to rice by dual cropping *Azolla* with rice after transplanting and incorporating it when the *Azolla* covers the field as a thick mat. *Azolla* can supply about 25–30 kg N/ha per incorporation (2, 4, 15). Nitrogen input can be increased further by growing the remaining *Azolla* from the first incorporation, so a second incorporation may be made at maximum tillering or panicle initiation. These agronomic approaches have resulted in rice yields equivalent to the yield obtained with 30–40 kg N/ha (5).

WEED CONTROL BY AZOLLA

During samba 1981–82, rice variety CO-43 was inoculated with *Azolla* at 100, 150, 200, 250, 300, 350, 400, 450, and 500 g/m² 7 d after transplanting (DT). Weeds were allowed to grow in all treatments and weeding was at 40 DT. The weed flora consisting of *Echinochloa glabrescens*, *E. stagnina*, *E. crus-galli*, and *E. colonum* were observed in the plots. Fresh wt of *Echinochloa* sp. in each treatment was recorded. Increase in *Azolla* inoculum decreased weed growth and increased grain yield (Table 9). Janiya and Moody (3) found that *Azolla* reduced total weed wt 79.1% 50 DT. Lumpkin and Plucknett (10) also reported that *Azolla* suppressed weeds in wetland rice.

Table 10. Effect of *Sesbania* and *Colocasia* as an intercrop on *Azolla* growth in summer.

Treatment	<i>Azolla</i> biomass yield (kg/plot)	Increase over control (%)
Control	4.5	-
<i>Colocasia</i> intercrop	5.4	16.5
<i>Sesbania</i> intercrop	6.4	37.4

Table 11. Effect of size of mud pots on growth of *Azolla* in soil extract and water in summer.

Pot size (liter)	Mean <i>Azolla</i> growth in water (g)	Mean <i>Azolla</i> growth in soil extract (g)
2	21.0	22.7
3	23.0	25.5
5	25.0	26.2
8	14.3	19.0
10	13.3	14.3

AZOLLA MAINTENANCE IN SUMMER

Azolla is primarily grown as a winter green manure, but fronds must be maintained over summer to reestablish *Azolla* in ricefields at the beginning of the rice crop season. Pest control methods are available, but the lack of heat-tolerant cultivars and effective heat avoidance measures results in low productivity or death in summer, particularly when water temperature is high.

No large-scale methods for using *Azolla* spores as seeding material are currently known. Maintaining and storing vegetative frond materials during the off-season are a problem for rice growers. If *Azolla* strains tolerant of temperate and tropical rice growing environments could be identified, production costs could be reduced.

In a May 1984 field study *Colocasia esculenta* and *Sesbania speciosa* were planted at 1.2 × 0.6 m spacing in 10-m² plots. Twelve plants/plot were maintained to provide shade to *Azolla*, which was inoculated at 200 g/m². Fresh cattle dung at 2.5 t/ha, 12 kg P/ha, and 25 kg furadan/ha were added to each plot. On the 14th day *Azolla* fresh wt was recorded. *Sesbania* and *Colocasia* supported *Azolla* growth in summer (Table 10). The shade obtained from *Sesbania* and *Colocasia* increased *Azolla* growth in summer.

In another study, mud pots of 2-, 3-, 5, 8-, and 10-liter capacity were used to maintain *Azolla*. Superphosphate at 5 ppm for water and 10 ppm for soil extract was added to the pots. Carbendazim and carbofuran at 20 ppm each were also added to control insect and disease pests. Fresh *Azolla* (20 g) was added to the pots, which were kept under sunlight. *Azolla* growth was determined on the 10th day by weighing the *Azolla* biomass (Table 11). Maintaining *Azolla* in mud pots during summer supported *Azolla* growth.

Table 12. Black rot incidence in different strains of *Azolla*.

<i>Azolla</i> culture	Disease incidence (%)
<i>A. pinnata</i> NE 13	51.5
<i>A. pinnata</i> NE 16	50.5
<i>A. caroliniana</i>	29.5
<i>A. filiculoides</i>	42.8
<i>A. nilotica</i>	71.5
<i>A. microphylla</i>	42.0
<i>A. pinnata</i> NE 6 (Bangkok)	34.1

Table 13. Control of black rot disease of *Azolla*.

Carbendazim (ppm)	Mean <i>Azolla</i> wt (g)	Increase over inoculated <i>Azolla</i> (%)	Increase over control (%)	Cost of carbendazim (Rs/ha) ^a
Control	8.3	—	—	—
10	16.7	11.1	100.1	2.00
20	19.0	26.7	128.0	4.00
30	19.2	27.8	130.1	6.00
40	19.8	32.2	138.1	8.00
50	20.7	37.8	148.1	10.00

^aUS\$1 = Rs10.60.

CONTROL OF BLACK ROT DISEASE IN *AZOLLA*

When *Azolla* plants reach maximum growth in the field, they decay in patches. Fungal pathogens attack the middle portion of the fronds first and then spread gradually to the branches. Complete rotting of plants occurs as black patches then the plants decay. The incidence of fungal diseases was reported by Sasi et al (13). The occurrence of black rot caused by *Rhizoctonia solani* was reported by Kannaiyan (4) who noticed that the disease was more severe when the fronds were attacked by snails.

The pathogens *R. solani*, *Fusarium* sp., *Sclerotium* sp., and *Rhizopus* sp. were isolated from diseased *Azolla* plants. *R. solani* was severe on *A. pinnata*. Different cultures of *Azolla* were inoculated with the *R. solani* and their disease tolerance was evaluated. Black rot occurred least on *A. caroliniana* and *A. pinnata* (Bangkok). The disease was severe on *A. nilotica* (Table 12).

Azolla fronds were inoculated with *R. solani* and then grown in mud pots. Increasing concentrations of carbendazim (10, 20, 30, 40, and 50 ppm) significantly reduced the disease incidence (Table 13). Kannaiyan et al (9) tested various fungicides and found that benomyl at 0.1 % and carbendazim at 0.2% inhibited the growth of *R. solani*. Neem cake at 500 kg/ha significantly controlled black rot (5).

PESTICIDE RESIDUE IN *AZOLLA*

The effect of granular pesticides on *Azolla* and their accumulation in *A. pinnata* was studied. *Azolla* was grown in 1-m² microplots in the field and

Table 14. Pesticide residues in *Azolla*.

Pesticide	Residue accumulation in <i>Azolla</i> (ppm) ^a	
	1d	7d
Phorate	4.90	1.28
Quinalphos	5.93	0.75
Carbofuran	1.83	0.60
BHC	7.27	1.87
Aldicarb	1.15	ND

^a ND = not detectable.

the granular pesticides phorate, quinalphos, carbofuran, BHC, and aldicarb were applied at 1 g/m². Twenty grams of *Azolla* samples were collected after 1 d and on the 7th day and analyzed for pesticide residues. The results are shown in Table 14. Residue accumulation was less than 2 ppm in all samples drawn on the 7th day. Carbofuran is commonly used in nurseries to control insect pests of *Azolla*. Carbofuran residue was lowest on *Azolla* samples taken on the 7th day.

REFERENCES CITED

- Govindarajan, K., S. Kannaiyan, and M. Ramachandran. 1979. *Azolla* manuring for rice. Aduthurai Rep. 3(7):89.
- International Network on Soil Fertility and Fertilizer Evaluation for Rice. 1982. *Azolla* decomposition and its fertilization effect on plant yield. Pages 1-36 in Report on the INSFFER *Azolla* study tour in Vietnam. International Rice Research Institute, P.O. Box 933, Manila, Philippines.
- Janiya, J.D., and K. Moody. 1981. Effect of herbicides on *Azolla*. Int. Rice Res. Newsl. 65(5):23.
- Kannaiyan, S. 1982. *Azolla* and rice. Page 39 in Multiplication and use of *Azolla* biofertilizer for rice production training. Tamil Nadu Agricultural University, Coimbatore, Tamil Nadu, India.
- Kannaiyan, S. 1985. Efficient utilization of *Azolla* for rice crop. Indo-US-SSP Programme Workshop. Indian Agric. Res. Inst. New Delhi, India (Abstr.)
- Kannaiyan, S., M. Thangaraju, and G. Oblisami. 1982. Influence of *Azolla* biofertilizer application as green manure and dual cropping on rice. Natl. Sci. Acad. Newsl. 5:50-62.
- Kannaiyan, S., M. Thangaraju, and G. Oblisami. 1984. Influence of neem cake on the growth of *Azolla pinnata*. Madras Agric. J. 71(1):66-68.
- Kannaiyan, S., M. Thangaraju, and G. Oblisami. 1983. Effect of *Azolla* green manuring on rice crop. Sci. Cult. 49(7):217-219.
- Kannaiyan, S., M. Thangaraju, G. Alagirisami, J. Venkatakrishnan, S. Kanagaraj, and G. Oblisami. 1983. *Azolla* application and rice crop response in Tamil Nadu. Int. Rice Res. Newsl. 8(3):17.
- Lumpkin, T.A., and D.L. Plucknett. 1980. *Azolla*: botany, physiology and use as a green manure. Econ. Bot. 34(2):111-153.
- Mani, L.S., S. Durairaj Muthiah, and G. Venkatesan. 1982. *Azolla* for Tirunelveli region. Tamil Nadu Agric. Univ. Newsl. 12(3):3.
- Santhanakrishnan, P., and G. Oblisami. 1980. Multiplication of *Azolla*. Pages 23-26 in *Azolla*—a biofertilizer. Tamil Nadu Agricultural University, Coimbatore, Tamil Nadu, India.
- Sasi, P.S., K.I. Wilson, and N.K. Sasidharan. 1979. Incidence of *Rhizoctonia solani* on *Azolla pinnata*. Curr. Sci. 48(5):216.
- Singh, P.K. 1978. Nitrogen economy of rice soils in relation to nitrogen fixation by blue-green algae and *Azolla*. Page 47 in Symposium on increasing yield in kharif. Central Rice Research Institute, Cuttack, Orissa, India.

15. Singh, P.K. 1979. Use of *Azolla* in rice production in India. Pages 407-418 in Nitrogen and rice. International Rice Research Institute, P.O. Box 933, Manila, Philippines.
16. Watanabe, I., C.R. Espinas, N.S. Berja, and V.B. Alimagno. 1977. Utilization of the *Azolla-Anabaena* complex as a nitrogen fertilizer for rice. IRRI Res. Pap. Ser. 11. 15 p.

DISCUSSION

MOCHIDA: Do you have any data on the seasonal abundance of *Azolla* diseases?

KANNAIYAN Black rot disease caused by *Rhizoctonia solani* is more prevalent in summer because of the high temperature.

ALI: You have shown that *Sesbania* can be used for *Azolla* canopy. What species of *Sesbania* was used and can it withstand prolonged flooding?

KANNAIYAN I used *Sesbania speciosa*. It grows well in waterlogged soil.

KULASOORIYA: Were BGA and *Azolla* inoculated together and if so, why? Would it not have been better to have allowed BGA to grow and then inoculated *Azolla* after BGA incorporation?

KANNAIYAN BGA and *Azolla* were inoculated together. BGA was inoculated as soil-based inoculum at 10 kg BGA/ha; *Azolla* was used as fresh inoculum at 200 g/m². Although BGA and *Azolla* are ecologically different, good establishment was noted. Rice crop response to BGA has been well established in India.

LADHA: How do you explain rice yield increase with *Lemna*, which does not fix N₂? Heterotrophically fixed N₂ associated with *Lemna* cannot explain the yield increase.

KANNAIYAN Some N₂-fixing bacteria are present in *Lemna* roots. Biomass produced by *Lemna* almost equals that produced by *Azolla*. During decomposition, N or other micronutrients might be available to the rice crop.

ESKEW: Could the soil disturbance involved in incorporating *Lemna* account for the yield increase observed? Watanabe has reported this effect. Should not such controls be included in experimental design?

KANNAIYAN: Soil disturbance during incorporation of *Lemna* might have some effect. Based on our experiment, it is evident that the application of *Lemna* increased grain yield. We do not know the mechanism, but N present in the plant or other micronutrients might become available during decomposition. As you suggest, it would be better to have a soil disturbance control.

Azolla use in Thailand

L. LOUDHAPASITIPORN AND C. KANAREUGSA

Soil Science Division, Department of Agriculture

Ministry of Agriculture and Cooperatives

Bangkok, Thailand

The price ratio of fertilizer to rice is relatively high in Thailand, so Thai farmers cannot afford to apply mineral N fertilizer at the levels recommended by the government. *Azolla* is a suitable N source for rice because of the relatively short time required to obtain a substantial N supply — as much as 3 kg N/ha per day — and because of *Azolla*'s tolerance for acidity, low soil fertility, and high temperature. Phosphorus is the the most important nutrient for *Azolla* multiplication. Two or three applications of phosphate to the growing *Azolla* crop result in a thick mat and high *Azolla* fresh weight. One crop of *Azolla* before or after transplanting and either incorporated into the soil or allowed to dry on the soil surface yielded N almost equivalent to 30 kg N mineral fertilizer/ha. Farmers in northern and eastern Thailand are poor, therefore, it is not practical for them to apply superphosphate to the *Azolla* crop. Instead, monoammonium phosphate or diammonium phosphate fertilizer can be used to cultivate *Azolla*. Rice yields are similar to those achieved when superphosphate is used to fertilize the *Azolla* crop. Besides providing a N source for rice, *Azolla* applied over time improves soil fertility, particularly of the sandy soils of northern and eastern Thailand.

Planting modern rice varieties, fertilizer use, and pest and disease control characterize rice culture in Thailand. Studies show that fertilization can dramatically increase rice yield. Thai farmers, however, cannot afford to apply chemical fertilizers in the quantities recommended by the government because the ratio of price of rice to commercial fertilizers is very low. Therefore, Thai scientists are interested in using biofertilizers.

STUDIES ON *AZOLLA* USE

Azolla is a suitable source of N for rice in Thailand because 1) it can provide a substantial amount of N in a short time — as much as 3 kg N/ha per day, and 2) it is tolerant of high pH and high temperature. Therefore, it can grow on low-fertility soils. *Azolla* is widely used in Thailand as a green manure for rice.

Azolla use in rice production has been studied in Thailand since 1976. Previous studies showed that *Azolla* grow in the sandy, low-fertility ricefields of northeastern Thailand. Growing *Azolla* 20 d before rice transplanting or 1 wk after transplanting results in high rice production, the same as when chemical N fertilizer is applied (2). In rainfed areas, rice farmers cannot sow *Azolla* before transplanting because of the short time there is standing water in the field. A practical method for *Azolla* utilization in rainfed areas is to sow *Azolla* in the field after rice transplanting and let it die off until N is released without incorporation. This method is more desirable for increasing rice yield in rainfed areas (3).

Azolla requires P for vigorous growth. Split applications of phosphate fertilizer two or three times during its growth cycle are recommended. *Azolla* investigations in Thailand can be summarized as follows:

1. *Azolla* will not grow unless phosphate fertilizer is applied at seeding.
2. Twenty-five kg P₂O₅/ha is necessary for *Azolla* culture in the ricefield. Split applications of phosphate at 7-10 d intervals are important, 2 applications in coarse soil and 3 in clay or acid sulfate soils.
3. Compound fertilizers such as 11-52-0 (monoammonium phosphate [MAP]) and 18-46-0 (diammonium phosphate [DAP]) can be used for *Azolla* culture with rice, and give *Azolla* yield similar to that achieved by applying 25 kg P₂O₅ superphosphate fertilizer/ha.
4. At inoculation rates of 312.5-625 kg *Azolla* fresh wt/ha, *Azolla* yields of 12.5-25 t/ha are achieved.
5. Neither the growing of *Azolla* before transplanting and incorporating into soil at transplanting, nor posttransplanting of *Azolla* and incorporating or nonincorporating, showed significant differences in rice yield. A single crop of *Azolla* before or after transplanting gave rice yield equivalent to that from applying 30 kg N/ha.
6. Use of *Azolla* as green manure over time, particularly on low-fertility and sandy soils of northeastern Thailand, increases organic matter content and gives yields equivalent to those realized from N fertilizer.

Table 1. *Azolla* growth as affected by phosphate application and its effect on rice yield at Ubon Ratchathanee Province, 1977.

Treatment ^a	Fertilizer N-P ₂ O ₅ -K ₂ O applied at transplanting (kg/ha)	Growth of fresh <i>Azolla</i> (t/ha)	Rice yield (t/ha)	Panicles/hill
1. No <i>Azolla</i>	0 - 30 - 25	—	2.6 c	7.2 bc
2. No <i>Azolla</i>	19 - 30 - 25	—	2.8 c	8.5 ab
3. No <i>Azolla</i>	38 - 30 - 25	—	2.9 bc	9.6 a
4. With <i>Azolla</i>	0 - 30 - 25	0.79	2.9 bc	8.5 ab
5. With <i>Azolla</i>	0 - 30 - 25	11.45	3.5 a	9.4 a
6. With <i>Azolla</i>	0 - 30 - 25	18.92	3.4 a	10.0 a
7. With <i>Azolla</i>	0 - 30 - 25	18.61	2.6 c	7.0 c

^a In treatments 4, 5, 6 *Azolla* was plowed into soil before transplanting. In treatments 6 and 7 K fertilizer was split 3 times at 5-d intervals. *Azolla* applied at seeding time.

AZOLLA NURSERIES

Azolla was maintained for 1 yr in 6 nursery ponds in rice experiment stations and 3 nursery ponds in northeast Thailand. At Sakon-Nakorn Rice Experiment Station, the nursery pond can produce enough *Azolla* for irrigated paddy fields. In 1982, it produced 15.5 t *Azolla* fresh wt/ha in the dry season and 31 t/ha in the wet season for Nam - Unn irrigated fields.

A preliminary study on the effect of *Azolla* on rice yield was conducted at Ubun Ratchathane in 1977. *Azolla* was inoculated 3 wk before transplanting. Rice yield was higher in the plot in which *Azolla* was incorporated before transplanting than in plots that received chemical N (Table 1) (2).

In rainfed areas, rice farmers cannot sow *Azolla* before transplanting because of the short time water is kept standing in the field. Posttransplanting culture of *Azolla* and not incorporating it into the soil gave higher rice yield

Table 2. Effect of posttransplanting and split phosphorus application for *Azolla* cultivation on rice yield, Ubun Ratchathane Province, 1978.

Treatment	Fertilizer (N-P ₂ O ₅ -K ₂ O) (kg/ha)	Rice yield (t/ha)
1. No <i>Azolla</i>	0 - 25 - 25	1.2 d
2. No <i>Azolla</i>	37.5 - 25 - 25	2.3 b
3. No <i>Azolla</i> , incorporation simulated	37.5 - 25 - 25	2.2 b
4. <i>Azolla</i> , posttransplanting culture, not incorporated; P ₂ O ₅ not split	0 - 25 - 25	1.9 bc
5. <i>Azolla</i> , posttransplanting culture, not incorporated; P ₂ O ₅ split	0 - 25 - 25	3.1 a
6. <i>Azolla</i> , posttransplanting culture, incorporated; P ₂ O ₅ not split	0 - 25 - 25	1.4 cd
7. <i>Azolla</i> , posttransplanting culture, incorporated; P ₂ O ₅ split	0 - 25 - 25	1.7 bc
8. <i>Azolla</i> , pretransplanting culture, incorporated; P ₂ O ₅ split	0 - 25 - 25	2.9 a

Table 3. Effect of monoammonium phosphate (MAP) and diammonium phosphate (DAP) at different rates on *Azolla* growth as green manure for rice production.

Treatment ^a	<i>Azolla</i> fresh wt (kg/m ²)		Rice yield (t/ha)	
	Sakon-Nakorn	Pimai	Sakon-Nakorn	Pimai
1. Check	—	—	1.4	1.7 d
2. <i>Azolla</i> + SP 18.75 kg P ₂ O ₅ /ha	0.73	1.85 d	2.1	2.7 bc
3. <i>Azolla</i> + SP 37.5 kg P ₂ O ₅ /ha	0.73	2.07 c	2.1	2.8 bc
4. <i>Azolla</i> + SP 56.25 kg P ₂ O ₅ /ha	0.70	1.95 d	2.0	2.6 bc
5. <i>Azolla</i> + MAP 18.75 kg P ₂ O ₅ /ha	0.79	2.54 ab	2.3	2.7 bc
6. <i>Azolla</i> + MAP 37.5 kg P ₂ O ₅ /ha	0.79	2.53 ab	2.1	3.0 ab
7. <i>Azolla</i> + MAP 56.25 kg P ₂ O ₅ /ha	0.77	2.66 a	1.9	3.2 a
8. <i>Azolla</i> + DAP 18.75 kg P ₂ O ₅ /ha	0.77	2.22 c	2.0	2.8 b
9. <i>Azolla</i> + DAP 37.5 kg P ₂ O ₅ /ha	0.73	2.49 ab	2.3	3.2 a
10. <i>Azolla</i> + DAP 56.25 kg P ₂ O ₅ /ha	0.73	2.59 a	2.4	3.3 a
Remark	ns		ns	

^a In treatments 2-10, 25 kg KCl/ha applied in addition to P₂O₅ levels indicated. SP (superphosphate fertilizer split 3 times at 7-d interval; MAP applied at *Azolla* inoculation; DAP applied at *Azolla* inoculation.

Table 4. Long time use of *Azolla* as green manure in ricefields at Pimai^a, northeastern Thailand (1979-83).

Treatment	Rice yield (t/ha)				
	1979	1980	1981	1982	1983
1. No <i>Azolla</i> + no fertilizer	1.9	2.4	2.1	3.2	2.0
2. No <i>Azolla</i> + chemical fertilizer ^b	3.2	3.5	3.1	3.7	2.9
3. <i>Azolla</i> culture before rice transplanting	2.5	2.8	3.2	3.8	3.0
4. <i>Azolla</i> culture after rice transplanting	2.5	2.6	2.9	3.4	2.9

^aSoil properties pH 5.2, O.M. 1.15%, sandy clay loam, CEC 12 meq/100 g. Total P, 80 ppm.

than pretransplanting culture of *Azolla* and incorporating it after it covers the area (Table 2).

Azolla cultivation with superphosphate is not practical in Thailand because phosphorus fertilizer is scanty and expensive. The use of MAP 11-52-0 and DAP 18-46-0 for *Azolla* cultivation was studied for promoting the use of MAP, DAP, and ammonium chloride from domestic chemical fertilizer production (1). The experiment at Sakon-Nakorn and Pimai indicated that *Azolla* fresh weight and rice yield increased when MAP or DAP was applied in plots (Table 3). The results at Sakon-Nakorn were not significant but indicated that *Azolla* and rice yields increased when MAP and DAP were applied.

Table 4 gives data on 5 years' trials on *Azolla* utilization compared with nitrogen chemical fertilizer. At the third to fifth year, use of *Azolla* before or after transplanting gave high rice yields. It was shown that *Azolla* can improve soil fertility, particularly in low-fertility soils like those in northeastern Thailand.

REFERENCES CITED

1. Loudhaphasitiporn, L., C. Tantiworawit, and C. Kanareugsua. 1982. Rates of mono-ammonium phosphate and di-ammonium phosphate application in *Azolla* cultivation as green manure for rice [in Thai]. Annual Report of Rice Soil and Fertilizer Group, Soil Science Division, Department of Agriculture, Thailand.
2. Swatdee, P., and others. 1977. Efficiency of *Azolla* on rice yield. Rice Fertilization Research, Rice Division, Department of Agriculture, Thailand. (mimeo.)
3. Swatdee, P., and others. 1978. Utilization of *Azolla* for rice cultivation. Rice Fertilization Research Branch, Rice Division, Department of Agriculture, Thailand. (mimeo.)

Use of *Azolla* in Brazil

M.F. FIORE

National Rice and Bean Research Center (CNPAP)
Caixa Postal 179, 74000 Goiania
Goias, Brazil

AND

K.G. GUTBROD

German Agency for Technical Cooperation (GTZ)
Frankfurt, Federal Republic of Germany

Three species of *Azolla* occur in several areas in Brazil, *Azolla caroliniana*, *A. filiculoides*, and *A. microphylla*. The growth and N-supplying potential of *Azolla* for irrigated rice have been studied at five sites. Relative growth rates of 0.25 - 0.30 g/g per d are possible in ricefields. *Azolla* produced the equivalent of 20-60 kg N/ha mineral fertilizer when incorporated as green manure before sowing, and 5-100 kg N/ha when intercropped. High temperature and solar radiation, nutrient deficiency, and insect pests are the main factors affecting *Azolla* growth. Potential uses and limitations for *Azolla* utilization in Brazil are discussed.

Rice is a staple food in Brazil, with per capita consumption of 45 kg/yr. The production of about 9 million t rough rice/yr almost meets the demand. Paddy rice accounts for more than 30% of total production (1), with an average yield of more than 3.7 t/ha (Comissão de Financiamento da Produção, unpubl.).

N input to the system is necessary for profitable yields, and, in the amounts required, tends to be the most expensive commercial product used in rice production. *Azolla* occurs in several sites throughout Brazil. In previous experiments, introduction of *Azolla* gave yield increases equivalent to those obtained with 15-100 kg N/ha or more. It appears that *Azolla* could become a source of N for paddy rice production in Brazil.

Basic research with *Azolla* in Brazil was begun in 1977 by the Centro de Energia Nuclear na Agricultura (Piracicaba, São Paulo). Field trials were initiated by the Empresa Catarinense de Pesquisa Agropecuária S.A. (Itajai, Santa Catarina) in 1981, Centro Nacional de Pesquisa de Arroz e Feijão (Goiania, Goias) in 1982, and Empresa de Pesquisa Agropecuária de Minas Gerais (Belo Horizonte, Minas Gerais) in 1983. *Azolla* has been cultivated on Belmonte Farm (Rolandia, Parana) since 1981.

This paper summarizes observations from surveys and synthesizes results of experiments at different sites.

OCCURRENCE

The occurrence of *Azolla* in Brazil was first cited in 1979 by Sehem (9) in Santa Catarina State and by Junk (4) in the Amazon Basin. In 1981 Lorenzi (6) reported *Azolla* in several other Brazilian states. *Azolla* species collected in eight states are shown in Figure 1. The Centro Nacional de Pesquisa de Arroz e Feijão maintains a collection of 28 Brazilian and 29 foreign *Azolla* strains.

In Brazil *Azolla* is commonly found on the surface of lakes formed by rivers, on ponds, swamps, and paddy rice soils. Common names include *almiscar-vegetal*, *samambaia-aquatica*, *murere-rendado*, *umbar-vegetal*, *musgoda-agua*, and *tapete-da-agua* (6).

In the north, northeast, and middle west regions, *Azolla* frequently occurs naturally during the dry season when rainfall is low and average temperature is above 22 °C. In the southern and southeastern regions *Azolla* is



1. *Azolla* species collected in Brazil.

found mainly during spring, when temperatures rise and rainfall is not yet abundant. Generally, *Azolla* appears among other aquatic plants, such as *Lemna* sp., *Pistia* sp., *Salvinia* sp., *Eichhornia* sp., *Oryza perennis*, and *Paspalum repens*, which protect it from turbulence, drifting, and high solar radiation. In several regions, *Azolla* is frequently found in paddy rice and farmers report better plant development.

AZOLLA GROWTH

In Brazil *Azolla* reaches relative growth rates (RGR) of 0.25 g/g per d in the field and up to 0.3 g/g per d in nurseries. Main growth-limiting factors are high temperature and solar radiation, and nutrient deficiencies.

Mineral nutrition

The main limiting element in *Azolla* nutrition in the field is P, which is frequently deficient in Brazilian soils (5). On an Alfisol (Paleudalf) in northern Parana, weekly broadcasting of 2-4 kg P/ha is necessary to maintain the P content in the *Azolla*, while on hydromorphic soils in Goias, P must be applied once weekly at 6-9 kg P/ha or split into 2 applications of 2 kg P/ha. Uniform application of less than 2 kg P/ha is technically difficult. Ca, Mg, and some micronutrients might become deficient after longer periods of field cultivation. Nutrient deficiency is less pronounced with shading, with low infiltration rates, and with a water level lower than 5 cm, especially on more fertile soil.

Climatic factors

Temperature. In the tropics, temperature in *Azolla* cover rises to 40°C in full sunlight. Accumulation of C and N per unit area are reduced mainly due to high temperatures. *A. filiculoides* will not grow well in the field in the summer north of the southern and southeastern regions. In the southern region, frost can damage *Azolla*. However, *A. filiculoides*, *A. caroliniana*, and *A. microphylla* have shown tolerance for -2°C night frost (3).

Solar radiation. Maximum light intensities occur in the rainy season, whereas maximum total radiation per day occurs in the dry season in the middle west, northeast, and northern regions. Observations suggest that *Azolla* growth becomes more dense in tropical climates where radiation is higher.

Insect parasites and diseases

Azolla is attacked by several insect pests, mainly in the warm season. Noldin and Ramos (7) reported *Nymphula*, *Chironomidae*, and *Molluscae* (*Pomacea* sp., *Marisca* sp.) feeding on *Azolla* in Santa Catarina. In north Parana, *Aphideae* and two *Diptera* species, probably *Stratiomyidae* and *Chironomidae*, were found. *Diptera*, probably *Chironomidae*, was also noted in Goias. Larvae of *Coleoptera* were observed as predators of small *Diptera*. *Molluscae*, frog larvae, and fish feed on *Azolla*. Monocrotophos at 0.3 liter/ha, with standing water

during the first week, efficiently controls pests for 2-3 wk. Decis (pyrethroid) at 0.5 liter commercial product/ha gave fair control in the first trials. Fungal attack was detected only in the greenhouse, mainly on *A. nilotica* and *A. rubra*.

USE IN RICE PRODUCTION

Species for rice cultivation

If well managed, indigenous species *A. caroliniana* and *A. microphylla* show RGR of 0.2-0.3 g/g per d throughout the year under subtropical and tropical conditions, and release N quickly to the rice crop. Their application will be more effective as an intercrop, unless longer cultivation before preplanting incorporation takes place. In tropical climates, their growth rates and N₂ fixation will be enhanced by shading compared to free cultivation. *A. filiculoides* is especially suited for preplanting incorporation because of its high C and N accumulation per unit area in subtropical winter and spring, and its slower N release due to large C:N ratio. An average RGR of 0.15-0.20 g/g per d can be expected.

Effect on rice: preplanting monocrop

Research by Purcino (unpubl.) in Minas Gerais showed that incorporating 180 g *A. caroliniana* dry wt/m² with 3.7% N supplied the equivalent of 50 kg N/ha mineral fertilizer to rice (Fig. 2). In north Parana, incorporating 240 g *A. filiculoides* dry wt/m² monocrop cover with 2.5% N yielded 7.7 t/ha (Table 1), equivalent to application of 60 kg N/ha. In Goias, incorporating 120 g *A. caroliniana* dry wt/m² with 3.0% N resulted in 20 kg N/ha to rice (3). Several incorporations of *A. caroliniana* and *A. microphylla* are estimated to supply at least 30-60 kg N/ha to rice.

In the greenhouse, ³²P was transferred from *Azolla* to the rice plant. Incorporating *Azolla* not only supplied P and N to rice, but also increased the mobilization of soil P (7), suggesting that other nutrients incorporated with *Azolla* should also be more readily available to rice. P application on *Azolla* incorporated before rice sowing is almost as efficient for rice growth as basal P application to rice.

Effect on rice: intercropping

In trials developed in Minas Gerais (Fig. 2), Goias (Fig. 3), and Parana (Table 1), intercropping without incorporation supplied the equivalent of 5, 20, and 100 kg N/ha mineral fertilizer, respectively. In combination with monocrop, incorporation gave yields higher than those obtained with 100 kg N/ha (Table 1). There is a positive interaction between rice and *Azolla* intercrop development. Rice shading at tillering enhances *Azolla* development and N-liberation, whereas if soil is very low in N, intercropping will not furnish N to rice unless it is incorporated. *Azolla* intercrop also reduces weed infestation.

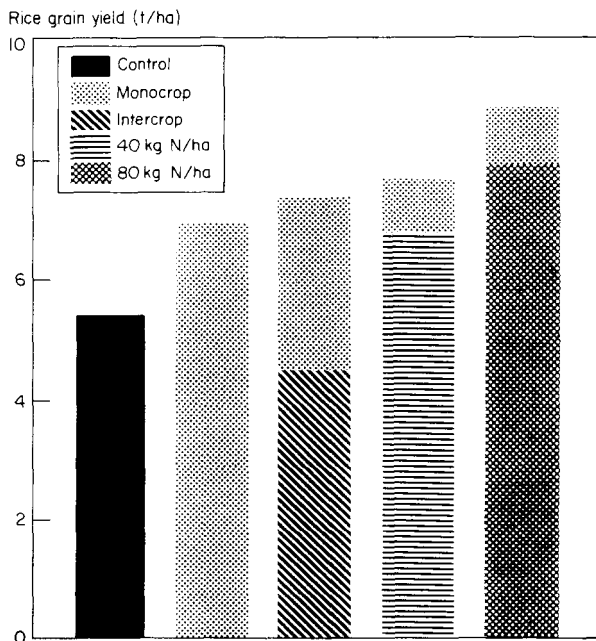

2. Effect of *Azolla* monocrop and intercrop, and ammonium sulfate on grain yield of rice variety CICA-8. Mean of 4 replications. Prudente de Moraes, Minas Gerais State (Purcino, unpubl.).

Table 1. Effect of *Azolla*, N applied as urea, and different soil preparation and sowing systems on rice grain yield (t/ha), variety CICA-9. Mean of 2 replications. Average plot size: 150 m². Belmonte Farm, Rolândia, Parana (3).

Treatment	Grain yield (t/ha) ^a				Mean	CV (%)	Scheffe Test a = 0.05
	A	B	C	D			
Control	5.6	4.3	7.0	7.2	6.0	22.0	a
Monocrop (<i>A. filiculoides</i>)	6.0	7.7	7.6	8.1	7.3	13.0	ab
Intercrop (<i>A. microphylla</i>)	8.7	8.2	8.4	8.8	8.5	3.0	bc
Monocrop + intercrop	9.3	9.4	8.9	9.7	9.3	4.0	
50 kg N/ha ^b	8.4	6.8	7.7	9.0	8.0	11.0	bc
100 kg N/ha ^b	8.4	8.4	8.0	9.1	8.5	5.0	bc
Mean	7.7	7.5	7.9	8.7	7.9		
C.V. (%)	17.0	24.0	8.0	10.0			

^a A = direct sowing, B = drill sowing into tilled soil, C = regerminated seed broadcast into puddled soil, D = transplanting into puddled soil. ^bUrea, broadcast.

Field management

Azolla field cultivation in Brazil will require four management practices:

1. Constant water level of 2-5 cm depth, which demands good soil leveling. On soil with infiltration rates higher than 20 mm/d, which are common in middle west fields, a constant water level is difficult to maintain; *Azolla* desiccates in less than 1 d after deposition on the soil surface.
2. P application at least weekly, to maintain P content of the *Azolla* constant during several cycles of multiplication. On well-leveled areas,

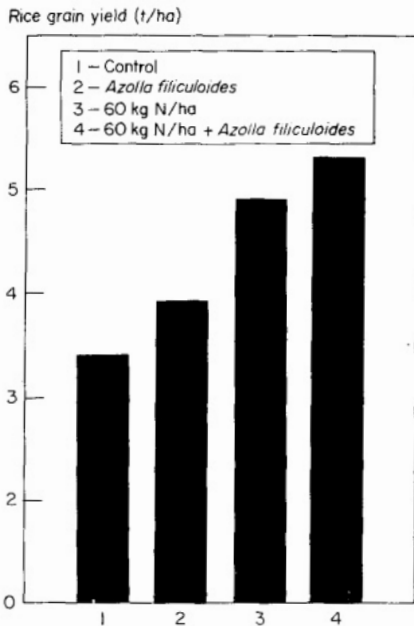

3. Grain yield of rice variety IAC-899 as affected by *Azolla filiculoides* intercrop and ammonium sulfate. Mean of 7 replications, Goiania, Goias State.

where a water level lower than 5 cm depth can be established, applications may be less frequent.

3. Density management during multiplication, consisting of inoculation of *Azolla* at 0.2-0.5 kg fresh wt/m² and transferring the *Azolla* when it reaches densities of 2-3 kg fresh wt/m² in subtropical conditions and 1-2 kg fresh wt/m² in tropical conditions.
4. Inoculation of pest-free *Azolla*, to delay pest population development during field multiplication. Pest control by conventional methods seems to be economical only in nurseries.

Techniques and management practices

Although labor in Brazil is relatively inexpensive, labor input in *Azolla* cultivation must be reduced because labor is not always readily available. Therefore, implements for *Azolla* cultivation are being introduced.

In *Azolla* cultivation, its transfer for inoculation is the most time-consuming operation, except fertilizing. That can be simplified by transferring *Azolla* with irrigation water. Well-nourished ferns do not suffer much damage, and losses are almost nil in clean trapezoidal irrigation channels. Other channels and even siphons might be used. *A. filiculoides* supports 9 mm water column pressure without serious injury (3).

OTHER USES

Azolla grown in fallow fields or on ponds and lakes can be used as feed for livestock, poultry, and fish, and as a source of anthocyanin. It can also be used

as green manure for vegetables (Leite, pers. comm.). *Azolla* has also been studied as an indicator of water pollution and as a depollutant.

LIMITATIONS

In Rio Grande do Sul and in some bigger irrigation systems, field size varies from 3 ha to more than 20 ha. In the smaller fields, more than 60% of irrigation water is drawn by pumps, making monocropping uneconomical unless N fertilizer could be largely replaced by biological N₂ fixation. In these areas, new large-scale technology would have to be developed. In other states, average paddy size is less than 1 ha, and water is largely drawn by gravity. In the middle west region, water availability before rice cultivation is low due to the previous dry season, and soils have high infiltration rates, which increases water demand and leaching of nutrients by submersion.

Farms attempting to cultivate *Azolla* have to make trainable labor forces available for nursery management and integrated pest control. Furthermore, administration time is required to assess *Azolla* production and coordinate it with the rice planting schedule. The success of *Azolla* application in Brazilian rice production will depend on the number of farms that can carry out such intensive on-farm management.

CONCLUSION

The potential of *Azolla* to supply N to rice with adequate management has been assessed by field trials in tropical and subtropical climates. Future *Azolla* research should concentrate on development of efficient field management methods that can be used by farmers. Main points to be studied are efficiency of P utilization, integrated pest control, strain screening for heat tolerance, and pest resistance.

Variations in *Azolla* N contribution to rice in experiments were mainly due to management practices. Handbooks on *Azolla* nursery cultivation, management practices, and application must be developed. Many farmers have considerable interest in *Azolla*. Introduction of *Azolla* into rice production in pilot projects should be encouraged so that farmers, extension workers, and researchers can participate in developing or adapting cultivation methods and evaluate *Azolla's* actual potential for agricultural utilization.

REFERENCES CITED

1. Empresa Brasileira de Pesquisa Agropecuária, Departamento Técnico Científico. 1981. Programa Nacional de Pesquisa de Arroz. Empr. Bras. de Pesq., Depart. de Inform. e Doc., Brasília, Distrito Federal. 69 p.
2. Fiore, M.F. 1984. Effect of *Azolla* on flooded rice production. *Pesq. Agropec. Bras.* 19(3):387-390.
3. Gutbrod, K.G. 1986. Effect of *Azolla* application on paddy rice in Brazil. *Z. Acker Pflanzenbau.* (in press)
4. Junk, W.J. 1979. Macrofitas aquáticas nas varzeas da Amazonia e possibilidades do seu uso na agropecuária. Inst. Pesq. da Amaz./Cons. Nac. de Desenv. Gent. e Tecn., Manaus, Amazonas. 23 p.
5. Lopes, A.S., and F.R. Cox. 1977. A survey of the fertility status of surface soils under "Cerrado" vegetation in Brazil, *Soil Sci. Soc. Am. J.* 41:742-746.
6. Lorenzi, J. 1982. Plantas daninhas do Brasil: terrestres, aquáticas, parasitas, tóxicas e medicinais. Nova Odessa, São Paulo. 361 p.
7. Noldin, J.A., and M.G. Ramos. 1983. Períodos de cultivo da *Azolla* e seus efeitos sobre o rendimento do arroz irrigado em Santa Catarina. Pages 109-111 in *Anais da 12ª. Reunião da Cultura do Arroz Irrigado*, 21-23 Sept. 1983. Inst. Riogrand. do Arroz, Porto Alegre, Rio Grande do Sul.
8. Sampaio, M.J.A.M., M.F. Fiore, and A.P. Ruschel. 1984. Utilization of radioactive phosphorus (^{32}P) by *Azolla-Anabaena* and its transfer to rice plants. In *Practical application of Azolla for rice production: proceedings of an international workshop*, Mayaguez, Puerto Rico, 17-19 Nov. 1982. W. S. Silver and E. C. Schroeder, eds. Martinus Nijhoff/Dr. W. Junk, Dordrecht/Boston-Lancaster.
9. Sehem, A. 1979. Salvinaceas. P.R. Reitz, ed. Itajai, Santa Catarina. 11 p. (Flora Ilustrada Catarinense, I parte).

DISCUSSION

KANNAIYAN: When do you inoculate *Azolla* in the intercropping system and when do you incorporate it?

FIORE: I inoculate *Azolla* in intercropping 40 d after sowing. I do not incorporate *Azolla*; it grows with the rice until harvest.

VAN HOVE: How did you measure relative growth rate?

FIORE: I measured *Azolla* fresh wt/m² at inoculation and just before incorporation, that is, 30-40 d after inoculation.

MOCHIDA: What kinds of pyrethroids do you use for pest control?

FIORE: Decis insecticide.

Use of *Azolla* in Sri Lanka

S.A. KULASOORIYA AND W.K. HIRIMBUREGAMA

Department of Botany
University of Peradeniya
Peradeniya, Sri Lanka

AND

S.W. ABEYSEKERA
Rice Research Station
Department of Agriculture
Ambalantota, Sri Lanka

The potential of *Azolla* as a biofertilizer for rice has been examined by field growth observations at several sites within the dry, intermediate, and wet zones of Sri Lanka. More systematic studies on the growth, N₂ fixation, and availability of *Azolla* N were conducted by regularly monitoring fresh weight biomass by acetylene reduction activity (ARA) measurements, and the use of ¹⁵N-labeled material. The effect of *Azolla* on rice yield compared to that of urea was evaluated over three crop seasons. Growth measurements showed that *Azolla* doubling time was 3.8-4.8 d, nitrogenase activity was high, and N derived from fixation ranged from 50 to 60%. *Azolla* increased rice yields 14% and reduced weed growth 34% in broadcast seeded rice, increased yield 22% and reduced weed growth 52% in transplanted rice, and increased yield 47% and reduced weed growth 43% in row-planted rice. Dual culture of *Azolla* with two incorporations in the rice cultivation cycle gave rice yields equivalent to applying 55-85 kg N/ha urea. Field-grown rice recovered N from soil-incorporated fresh *Azolla* more efficiently than it did from soil-incorporated urea.

Azolla has not been used traditionally as a green manure for rice in Sri Lanka and has remained a mere botanical curiosity until recently. Research on *Azolla* in relation to rice culture began in the mid-1970s and a preliminary investigation revealed it could increase rice yield. However, whether *Azolla* could withstand the high light intensities and high temperatures in the dry zones of Sri Lanka, where rice is predominant, had to be examined before field application. An *Azolla pinnata* strain from Peradeniya could tolerate high light and temperatures as long as P nutrition was adequate (3). These laboratory experiments were later confirmed by field trials, which showed that four strains of *A. pinnata* could grow rapidly in the dry zone of southern Sri Lanka and exhibit high nitrogenase activity during growth (4). A more recent study showed that adding 5-7 kg P/ha per wk could increase *Azolla* biomass 20-fold and that N content of the *Azolla* increased linearly with the addition of P (2).

Further experiments have been conducted to:

- examine the ability of *Azolla* to grow in ricefields in several sites in Sri Lanka,
- measure and quantify N₂ fixation by field-grown *Azolla*,
- study the availability of *Azolla* N to rice in comparison to urea N, and
- assess the effect of *Azolla* incorporation on rice yield.

This paper will deal primarily with these experiments.

AZOLLA EXPERIMENTS

An *Azolla* Bank, consisting of different strains of *Azolla*, collected locally and abroad, is maintained in soil-water culture at the Central Agricultural Research Institute of the Department of Agriculture in Gannoruwa, Peradeniya, as an essential component of the *Azolla* research program. Material from this collection is available for research on *Azolla* in Sri Lanka.

The ability of *Azolla pinnata* to colonize ricefields under natural conditions was examined by inoculating *A. pinnata* into flooded fields and observing its growth. *Azolla* grew successfully in all the localities examined, which are situated in the wet, intermediate, and dry zones of Sri Lanka (Fig. 1). A more accurate assessment of growth and N₂ fixation was done at Ambalantota in southern Sri Lanka, where the terrain is undulating to flat, the rice soils are of the low humic gley type, and the 75% expectancy of annual rainfall is <500 mm.

A replicated field trial was conducted using 5-m² plots, arranged in a randomized complete block design, to compare the growth of two local strains of *A. pinnata* with two exotic strains. Each plot was inoculated with 180 g of *Azolla* fresh wt/m² (1.8 t/ha) together with 6 kg triple superphosphate (TSP)/kg *Azolla* fresh wt, and 1 kg of carbofuran (3% ai)/kg *Azolla* fresh wt. TSP powder at 3 g/m² was broadcast over *Azolla* every 5 d and 0.5 g carbofuran/m² was added at the initial sign of any pest attack. *Azolla* fresh wt from each plot was measured every 3 d. Biomass measurements were stopped after 15 d, because most of the plots had complete *Azolla* cover by that time. Acetylene reduction activity (ARA) measurements were done on these 15-d cultures using transparent plastic baby feeding bottles to which were attached PVC tubes closed with subaseal stoppers. Eight bottles were placed in each plot and incubated with 20% acetylene in air for 20 min. This short incubation time was adopted to minimize the effect of temperature increases within the incubation bottles. Two-ml aliquot gas samples, stored in vacutainers, were analyzed for ethylene by gas chromatography.

The rate of *Azolla* growth was also monitored in a large (200 m²) field in which 10 kg inoculum (fresh wt) increased 50-fold in 3 wk, a doubling time of 3.8 d.

Quantitative assessment of N₂ fixation

N₂ fixation was assessed in 1-m² microplots lined with plastic sheets and banded by 25-cm levees. The ¹⁵N-dilution method (1) was adopted, with

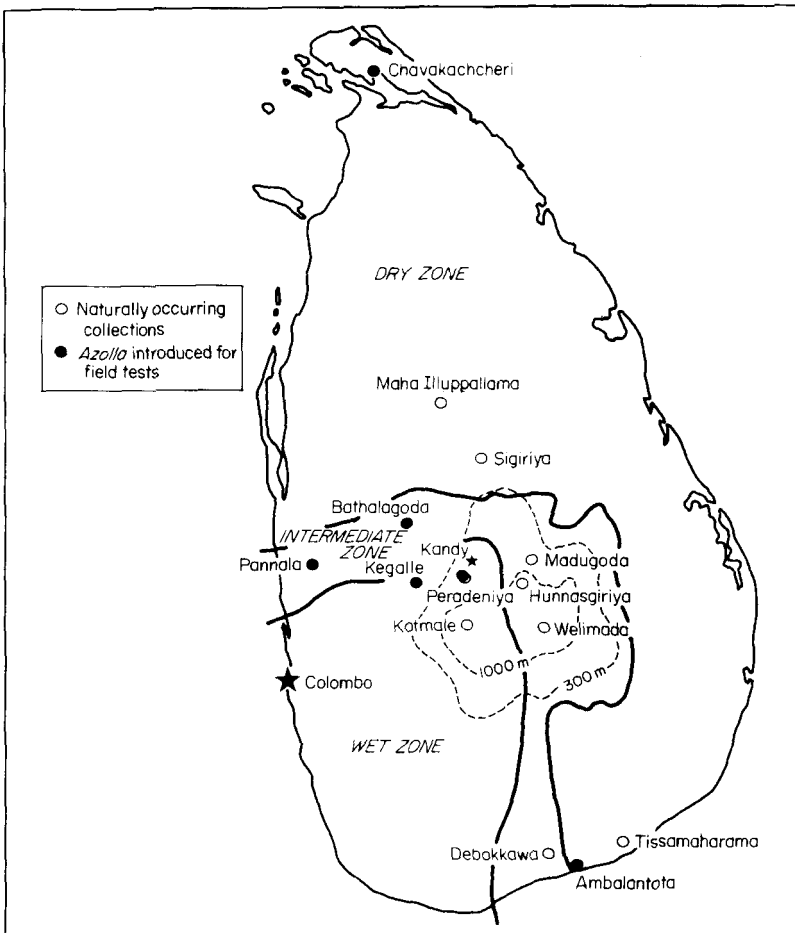

1. Sites in Sri Lanka where *Azolla* growth has been observed.

A. pinnata and *A. microphylla* as the N_2 -fixing test plants, and *Salvinia* sp. and *Lemna major* as the nonfixing reference plants. The experiment was carried out in monoculture as well as in dual culture with rice, transplanted at 15×15 cm. After land preparation and flooding to a level of 5 cm with irrigation water, ^{15}N -labeled urea [11.3% atomic emissivity (a.e.)], was added to give a concentration of 40 ppm N. Each 1-m^2 microplot was subdivided into 4 equal quadrants using pieces of bamboo floated on the floodwater. Five g (fresh wt) of each plant type was added to each subplot as inoculum. In this manner, the test and the reference plants were kept immersed in the same solution containing ^{15}N , but effectively separated from one another. The plants were harvested after 6 wk, dried, the dry weights recorded, and then powdered. Aliquot samples of this material were analyzed for ^{15}N enrichment by emission spectrometry at the International Atomic Energy Agency laboratories in Seibersdorf, Austria.

Availability of *Azolla* N to rice

The availability of *Azolla* N to rice was investigated in 1-m² microplots lined with plastic sheets and banded by 25-cm levees. *Azolla*, pre-labeled by growing it with ¹⁵N-labeled urea (11.3 a.e.), was incorporated 2 and 6 wk after transplanting. The availability of *Azolla* N was compared with that of urea N by having a treatment with ¹⁵N-labeled urea (5% a.e.). Each treatment was replicated 4 times and arranged in a randomized complete block design.

Effect of *Azolla* on rice yield

The effect of *Azolla* on the yield of broadcast seeded, transplanted, and row-planted rice was examined at Peradeniya in a replicated field experiment using 4- × 3-m plots. In this experiment *Azolla* was inoculated at 100 g fresh wt/m², 20 d after broadcasting and 2 d after transplanting 18-d-old rice seedlings. No fertilizers were applied. The *Azolla* cover was incorporated only once (30 d after inoculation) during crop growth.

Weed suppression by *Azolla* under different rice planting patterns was assessed at Peradeniya and at Ambalantota by recording the weed biomasses 30 d after *Azolla* inoculation. The dry weights of weeds removed from 20 randomly selected 1-m² areas per plot were recorded.

At Ambalantota, a comprehensive field trial was conducted for three consecutive seasons to evaluate the effect of *Azolla* on rice yield in comparison to urea fertilizer. This experiment was conducted in 4- × 4-m plots that had the following treatments.

1. Rice with 0 fertilizer,
2. Rice + P and K + 0 kg N/ha,
3. Rice + P and K + 20 kg N/ha,
4. Rice + P and K + 40 kg N/ha,
5. Rice + P and K + 60 kg N/ha,
6. Rice + P and K + 80 kg N/ha,
7. Rice + P and K + 100 kg N/ha,
8. Rice + P and K + 10 kg N/ha + *Azolla* (Peradeniya),
9. Rice + P and K + 10 kg N/ha + *Azolla* (Debokkawa), and
10. Rice + P and K + 10 kg N/ha (Bangkok).

The rice variety used was AT-16 (105 d duration).

Table 1. Biomass and acetylene reduction activity (ARA) of 15-d-old mono-culture of *Azolla pinnata* collections grown in 5-m² field plots at Ambalantota, in the low-country, dry zone of Sri Lanka.

<i>Azolla</i> collection	<i>Azolla</i> fresh wt ^a (g/plot)	ARA ^b (μmol C ₂ H ₄ /g fresh wt per h)	N ₂ fixation (kg N/ha per d) ^c
Debokkawa	8000 ± 54	2.59 ± 1.50	3.48
Bangkok	7892 ± 72	2.44 ± 1.36	3.22
India	7600 ± 124	1.82 ± 1.18	2.32
Peradeniya	7125 ± 712	2.41 ± 1.36	2.88

^aMean of four replications. ^bMean of 8 samples incubated with 20% acetylene from 1330 to 1430 CST, under 90 klx at 34-37 °C. ^cN₂ : C₂H₄ = 1:4.

Each treatment was replicated 4 times and arranged in a randomized complete block design. P was applied as TSP and K was applied as muriate of potash at levels recommended for AT-16. N was provided as urea with 1 basal application (10 kg N/ha) to all the treatments, except treatments 1 and 2. This was followed by 2 topdressings given to treatments 3 to 7 at 2 and 6 wk after transplanting. Eighteen-day-old seedlings were transplanted at 20 × 20 cm spacing and *Azolla* was inoculated at 100 g fresh wt/m², 3 d after transplanting.

Experiments in farmers' fields

A preliminary nonreplicated experiment was conducted in farmers' fields at three sites in which the effect of *Azolla* incorporation before and after transplanting was compared with the recommended fertilizer applications.

RESULTS

The more systematic investigations on the growth of *Azolla* showed that in the dry zone of southern Sri Lanka, *A. pinnata* could grow rapidly in monoculture, achieving doubling times of 4.8-3.8 d. The results on the estimation of the growth of and N₂ fixation by the four strains of *A. pinnata* tested are shown in Table 1. The biomasses attained in 15 d by the 4 strains did not differ significantly from one another and ARA ranged from 1.82 to 2.59 μM/g fresh wt per h. Thus, *A. pinnata* was capable of rapid growth and high nitrogenase activity, even at 90 klx and temperatures between 34 and 37°C.

Successful growth of *Azolla* was also observed at all other sites tested, showing the wide adaptability of this plant to the humid tropical conditions in Sri Lanka. However, pest attacks were observed at all sites, especially during the hot, dry season.

N₂ fixation measured by the ¹⁵N-dilution technique (Table 2) shows that N derived from fixation ranges from 50 to 66% and that there is no difference in N₂ fixation by *Azolla* under monoculture or dual culture. The quantities of N fixed under these conditions ranged from 8.5 to 11.1 kg/ha (Table 3).

Results presented in Table 4 show that from the 53 kg N/ha applied as fresh *Azolla*, nearly 30% went into the panicles and 13% into the straw, giving a total nitrogen recovery of 43%. In the case of the 80 kg N/ha given as urea, only 28% was recovered in the panicles and 9% in the straw, a total of 37%. The efficiency of N utilization from *Azolla* is higher than from urea (Table 4).

Table 2. Nitrogen fixation by species of *Azolla* grown in a ricefield for 42 d, measured by the ¹⁵N-dilution technique (% N derived from fixation).^a

Reference plant	Monoculture		Dual culture with rice	
	<i>A. microphylla</i>	<i>A. pinnata</i>	<i>A. microphylla</i>	<i>A. pinnata</i>
<i>Salvinia</i> sp.	54 ± 11	50 ± 18	61 ± 7	66 ± 4
<i>Lemna major</i>	56 ± 3	53 ± 14	55 ± 9	61 ± 6

Values are means of four replications.

Table 3. Quantity of nitrogen fixed by 2 species of *Azolla* grown in a ricefield for 42 d.

Reference plant	Test plant	Monoculture			Dual culture with rice		
		Dry wt (kg/ha)	N yield (kg/ha)	Ndff ^a (kg/ha)	Dry wt (kg/ha)	N yield (kg/ha)	Ndff ^a (kg/ha)
<i>Salvinia</i> sp.	<i>A. pinnata</i>	579 ± 102	18.1 ± 7	8.5 ± 3	652 ± 9	16.6 ± 4	11.1 ± 3
	<i>A. microphylla</i>	649 ± 89	17.5 ± 2	9.3 ± .8	638 ± 94	17.2 ± 2	10.5 ± 1
<i>Lemna major</i>	<i>A. pinnata</i>	579 ± 102	18.1 ± 7	9.1 ± 4	652 ± 9	16.6 ± 4	10.2 ± 3
	<i>A. microphylla</i>	649 ± 89	17.5 ± 2	9.4 ± .8	638 ± 94	17.2 ± 2	9.4 ± 1

^a Ndff = nitrogen in *Azolla* biomass derived from fixation.

Table 4. Recovery of nitrogen from *Azolla* and urea by field-grown rice.

Fertilizer source	Plant part	Dry matter yield (kg/ha)	N yield (kg/ha)	Ndff ^a (%)	N recovery (%)
<i>Azolla</i> (53.28 kg/ha)	Straw	1293 ± 158.63	9.57 ± 0.92	73.63 ± 8.26	13.21 ± 1.95
	Panicle	2060 ± 390	24.31 ± 5.02	66.50 ± 7.55	29.87 ± 3.31
	Total	3352.75 ± 532.35	33.88 ± 5.58		43.09 ± 3.85
Urea (79.63 kg/ha)	Straw	1358 ± 250	13.14 ± 2.76	54.75 ± 5.74	8.98 ± 1.35
	Panicle	2639 ± 274	40.48 ± 4.67	55.25 ± 5.25	27.90 ± 1.97
	Total	3397 ± 408.8	53.62 ± 5.75		36.83 ± 1.55

^a % N in rice derived from fertilizer (either *Azolla* or urea). 5.5 kg N/ha urea together with 54.6 kg P₂O₅/ha and 18.5 kg K₂O/ha were added as basal dressing to all treatments. ¹⁵N-labeled, fresh *Azolla* was incorporated at 21.3 t/ha and 18.5 t/ha and ¹⁵N-labeled urea was incorporated at 92.6 kg/ha and 80.5 kg/ha, 2 and 6 wk after transplanting rice.

Table 5. Grain yield and straw yield of rice grown in three planting patterns in the wet zone of Peradeniya.

Planting pattern	Grain yield (t/ha)		Increase (%)	Straw yield (t/ha) ^a		Increase (%)
	Without <i>Azolla</i>	With <i>Azolla</i>		Without <i>Azolla</i>	With <i>Azolla</i>	
Broadcast seeded	1.4	1.6	14	2.77	3.45	25
Transplanted, 20 × cm spacing	2.2	2.7	22	2.56	3.10	21
Transplanted in avenues	2.1	3.0	47	2.47	3.41	39

^a Mean of 4 replications.

The effect of *Azolla* on rice yield under different planting patterns is given in Table 5. Yield increased 14% for broadcast seeded rice, 22% for transplanted, and 47% for avenue planted. The yield values per hectare, however, are low, which reflects the low fertility of these atypical fields at Peradeniya.

Weed growth suppression by *Azolla* ranges from 34 to 53% (Table 6).

The natural fertility of the fields at Ambalantota was high because they produced 3.74-3.98 t/ha without fertilizer. P and K fertilizers increased yields only slightly, but there is a linear relation to N fertilizer response up to 100 kg

Table 6. Effect of Azolla on weed growth, Sri Lanka.^a

Planting pattern	Peradeniya			Ambalantota		
	Weed growth (g/plot) ^b		Weed suppression (%)	Weed growth (g/plot) ^b		Weed suppression (%)
	Without <i>Azolla</i>	With <i>Azolla</i>		Without <i>Azolla</i>	With <i>Azolla</i>	
Broadcast seeded	35.0	23.3	34.4	n.d.	n.d.	n.d.
Transplanted at random	n.d.	n.d.	n.d.	384	180	53
Transplanted in avenues	100.6	55.6	45	510	297	42
Transplanted, 20 × 20 cm spacing	74.3	48.6	35	699	331	52

^an.d. = not determined. ^bDry weight of weeds at 30 d after transplanting rice.

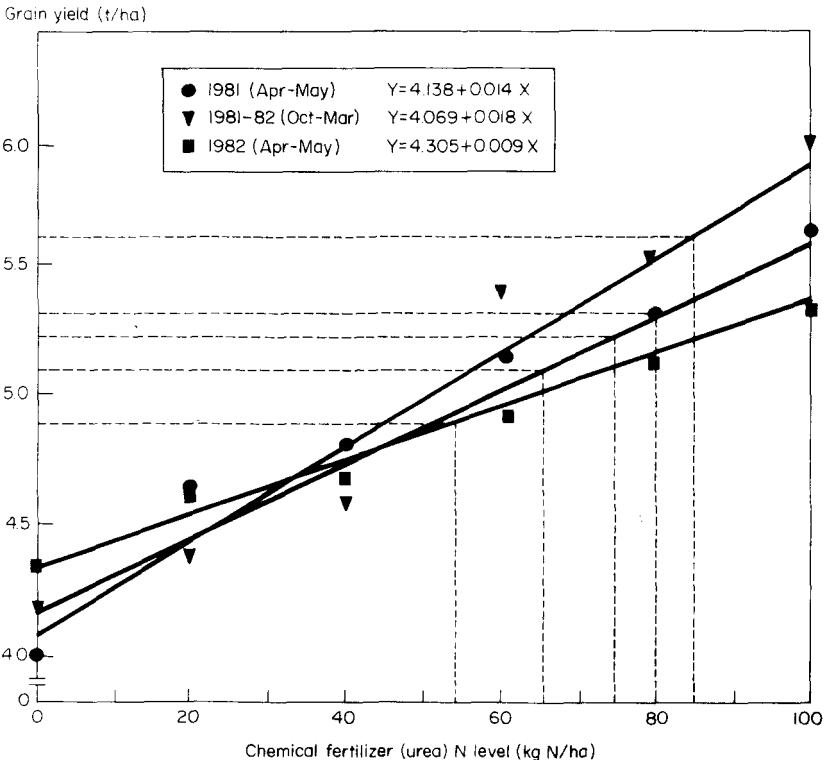

2. Estimated linear relationship between grain yield and chemical fertilizer (urea) N levels for three consecutive seasons. Broken lines indicate the performance of the *Azolla* incorporated treatments in terms of kg N/ha added as urea.

N/ha. The performance of *Azolla* compared to urea is very encouraging (Fig. 2) and the effects of *Azolla* can be interpreted as equivalent to yields that would have been obtained from 55-84 kg N/ha as urea.

CONCLUSION

Azolla growth and N₂ fixation in field plots in the predominantly rice growing dry zones of southern Sri Lanka compare favorably to those reported from other Asian countries.

Investigations on the effect of *Azolla* on rice grain yield have consistently given positive results. This demonstrates that where successful *Azolla* growth can be achieved, it will have a beneficial effect on rice. Even the preliminary trials in farmers' fields have given encouraging results. Yields obtained by *Azolla* incorporations before and after transplanting did not differ significantly from those obtained with recommended fertilizer applications.

Results on weed suppression by *Azolla* demonstrate that the positive effect of *Azolla* on rice is not limited to N₂ fixation. There are other factors such as buildup of organic matter resulting in improved soil texture, cation exchange capacity, moisture retention, etc., by which *Azolla* use could benefit the crop. Our investigations on such factors, however, are not conclusive.

Similarly, certain constraints that may limit the widespread use of *Azolla* in Sri Lanka became apparent during these investigations. Wherever *Azolla* growth was attempted, pest attacks were encountered. Although common pesticides could control these pests, their use might not be economical and could lead to environmental pollution. Another common observation was the limited P availability in the floodwater. Further investigations are needed to develop management practices to preclude the need for frequent P applications, which would be a disincentive to farmers. Another factor of paramount importance is the availability of controllable water. Even with tank irrigation in Sri Lanka, water supply is not always controllable. Farmers find it difficult to have standing water when they need it to grow *Azolla*, to drain it when they have to incorporate the *Azolla*, and reimound it for subsequent regrowth.

In Sri Lanka limited research has been done on *Azolla* and *Azolla* is not given high priority in the national rice research programs. Nevertheless, the widespread natural occurrence and the positive results obtained from research done so far indicate that *Azolla* has a good potential as a biofertilizer for rice in Sri Lanka.

REFERENCES CITED

1. Fried, M., S.K.A. Danso, and F. Zapata. 1983. The methodology of measurement of nitrogen fixation by non-legumes as inferred from field experiments with legumes. *Can. J. Microbiol.* 29:1053-1062.
2. Gunapala Nirmala, and S.L. Amarasiri. 1984. Effect of addition of phosphorus on the growth of *Azolla*. *Trop. Agric.* (in press)
3. Kulasooriya, S.A., W.K. Hirimburegama, and R.S.Y. de Silva. 1980. Effect of light, temperature and phosphorus on the growth and nitrogen fixation in *Azolla pinnata* native to Sri Lanka. *Oecol. Plant.* 1(4):355-365.
4. Kulasooriya, S.A., W.K. Hirimburegama, and S.W. Abeysekera. 1982. Growth and nitrogen fixation in *Azolla pinnata* under field conditions. *J. Nat. Sci. Counc. Sri Lanka* 10(2):205-212.

DISCUSSION

WATANABE: I suspect that *Azolla* inhibits the growth of direct-seeded rice. How do you manage under this condition?

KULASOORIYA: It depends on the time of *Azolla* inoculation. If *Azolla* is added when rice seedlings are too small, rice growth can be inhibited, but if the seedlings are properly established rice growth is not inhibited.

KANNAIYAN: Would you say that the yield increase in double row planting is due to spacing or to *Azolla*?

KULASOORIYA: We had control plots under the same planting pattern (Table 5). The yield increase percentages shown are those over the control. Therefore the yield increases recorded are due to *Azolla*.

CRASWELL: Are you aware of a research program being developed in Sri Lanka to introduce an insect for biological control of *Salvinia*? If this insect also attacks *Azolla*, the problems of *Azolla* cultivation in your country could become even more serious than indicated in your paper.

KULASOORIYA: I am aware of this project. Right now these experiments are conducted under controlled conditions inside laboratories. Once these insects are released, and if they start attacking *Azolla* as well, it would be a problem for large-scale *Azolla* cultivation.

LADHA: Do you know if the N uptake patterns of *Lemma*, *Salvinia*, and *Azolla* are the same?

KULASOORIYA: We have not measured this.

Utilization of *Azolla* in agricultural production in Guangdong Province, China

ZHANG ZHUANG-TA, KE YU-SI, LING DE-QUAN,
DUAN BING-YUAN, AND LIU XI-LIAN*

Soil and Fertilizer Institute
Guangong Academy of Agricultural Sciences
Guangzhou, Guangdong, China

China has a long history of culturing and using *Azolla* (1, 5). Traditionally, the vegetative mass of *Azolla* has been applied to conserve the seedlings for propagation. Main problems in this method are that under high or low temperature, the growth of vegetative mass is limited, insect and disease damage is severe, and preservation of seedlings over winter or summer is difficult. Systematic studies on the effective utilization and ways to consistently grow *Azolla* to control main insect pests and to sexually reproduce *Azolla* began in the 1960s. This paper reports the results of such studies.

EFFECTIVE UTILIZATION OF *AZOLLA*

Incorporating *Azolla* into winter-fallowed paddy fields as the basic manure for early rice culture is a main way of utilizing *Azolla* as a fertilizer. *Azolla* used as basic manure in rice culture can greatly increase yield. In Kwangtung Province, applying 22.5-37.5 t *Azolla* /ha increased yield 585-795 kg/ha. The average rate of yield increase is 9.6-13%.

Used as basic manure on rice seedling beds, *Azolla* can improve the quality of seedlings (Table 1). After transplanting, the rice seedlings grow and tiller quickly, and the rate of seedling establishment is higher.

Azolla contains N, P, and K. N is the main rice yield increasing factor (2). N content of fresh *Azolla* is generally about 0.25% (varying with species, climate, and propagating technique). Twenty-five to thirty tons *Azolla* fresh wt/ha can supply 62.5-75.0 kg N/ha to rice plants. After incorporation, decomposed *Azolla* contributes nutrients to the growth and development of rice plants, promoting tillering and enhancing the growth rate of panicles. The general increase in number of grain per panicle is about 5 grains; 1,000-grain weight increases by 1 or 2 g.

Azolla cultivation can improve soils and enhance their fertility. The lignin content of *Azolla* is relatively high (6). Up to 39% of its dry matter can be converted into soil organic matter. Its conversion rate is higher than that of

*Deceased

Table 1. Effect of *Azolla* as basic manure on quality of rice seedlings on seedline beds.

<i>Azolla</i> applied (t/ha)	Seedling ht (cm)	Leaves (no.)	Leaf width (mm)	Roots (no.)	Pseudostem width (mm)
1.5	24.0	4.4	5.2	13.6	4.1
3.0	22.1	4.2	6.0	11.1	3.8
Check	21.1	4.1	5.2	10.9	3.4

From Agriculture Bureau of Xin Hui County, Kwangtong Province, 1981.

Table 2. Nutrient content of *Azolla* and of some green forage crops.

Crop	Nutrient content (% dry wt)					
	Crude Protein	Crude fat	Fiber	Ash	Ca	P
<i>Azolla</i>	25.0	3.1	11.5	17.3	1.52	0.96
Water hyacinth	20.3	1.8	13.8	22.6	1.19	2.90
Water lettuce	19.4	3.0	4.8	35.6	0.69	0.79
Sweet potato shoot	17.7	3.1	13.9	9.8	1.81	0.43
Milk vetch	20.8	5.7	23.2	7.5	0.79	0.62
Clover	16.6	4.0	26.1	11.3	1.24	0.82

From Soil and Fertilizer Research Institute of Kwangtong Agricultural Science Academy, 1983.

milk vetch *Astragalus sinicus* L. and rice straws. After many years' cultivation of *Azolla*, bearing strength, density, and water infiltration decrease. Porosity increases, the topsoil is built up, and moisture-holding capacity improves (7).

Azolla fed to pigs increases pig weight significantly. Growing pigs fed with *Azolla* gained 26.2 g/d more than those fed only with concentrated feed, a 5.2% weight increase. Starter pigs fed with *Azolla* gained 28.4 g/d more than those that did not receive *Azolla*, a 9.4% weight increase. On the average 97.4 kg fresh wt *Azolla* produces 1 kg live weight in pigs.

Azolla can be used as a green forage for geese. The daily weight gain of geese fed with *Azolla* is close to that of geese fed with vegetable.

The weight of grass carp fed with *Azolla* is 22.8% more than that of fish fed only concentrated feed. Every 31.5 kg *Azolla* fresh wt increases the weight of grass carp 1 kg, equal to the forage coefficient of common fish fed with green forage.

There is no negative effect on the quality of fish. Chemical analysis showed that the content of many amino acids such as lysine, cystine, methionine, and glutamic acid in fish fed with *Azolla* is about the same as that of fish fed with concentrated feed or green forage.

The factors increasing the weight gain of pigs, geese, and fish fed with *Azolla* are mainly attributed to the many kinds of nutrients contained in *Azolla*. *Azolla* contains a large proportion of crude protein, crude fat, Ca, and P. Crude protein content reaches 25%, more than that of the green forage crops, such as sweet potato shoot, water hyacinth, and water lettuce (Table 2).

Table 3. Amino acid contents of *Azolla* and some green forage crops.

Amino acid	<i>Azolla</i>	g/100 g protein, dry wt				
		Water hyacinth	Water lettuce	Sweet potato shoot	Milk vetch	Clover
Lysine	5.48	6.75	7.99	0.28	6.59	6.27
Histidine	2.28	2.36	2.68	1.37	3.13	2.65
Arginine	6.84	6.45	6.86	2.00	6.54	5.60
Aspartic acid	9.72	7.09	10.77	11.94	8.75	10.24
Threonine	5.00	3.84	5.04	2.37	3.85	4.39
Serine	4.92	3.89	4.93	1.97	4.18	4.46
Glutamic acid	12.44	10.93	14.69	8.56	12.40	11.08
Proline	4.04	4.43	4.43	—	2.64	3.31
Glycine	5.88	4.98	5.77	0.48	5.14	5.00
Alanine	6.08	4.78	6.59	2.08	5.38	5.30
Valine	4.88	4.04	5.00	1.88	5.91	5.48
Methionine	1.40	1.87	1.56	0.72	1.29	1.33
Isoleucine	4.56	3.79	3.87	1.36	4.62	4.28
Leucine	8.64	6.89	8.45	4.04	8.32	7.65
Tyrosine	3.84	3.84	3.97	1.55	4.47	4.16
Phenylalanine	4.68	4.58	4.89	2.36	5.00	5.12

Amino acid content is also high (Table 3). Lysine content is 0.42% more than that of concentrated feed composed of rough rice, maize, and bran.

RECURRENCE AND CONTROL OF MAIN *AZOLLA* INSECT PESTS

Control of insect pests is the key to propagating *Azolla* successfully. There are three main injurious insects of *Azolla* in Kwangtung Province: *Azolla* midges (Diptera, Chironomidae), *Azolla* snout moth, and *Azolla* grey snout moth. All three can damage *Azolla* severely, but the most dangerous is the *Azolla* midge (3).

Azolla midges include four species: two-banded midge *Polypedilum iuinoense* Hauber, brown midge *Tendipes attenuatae* Wather, green midge *T. riparius* Meigen, and yellow midge *Cricotopus* sp. The two-banded midge is the most populous species causing the most serious damage to *Azolla* (4).

The time of peak outbreak varies with each of the four midges. The brown midge occurs from April to May and from July to August; the green midge in May and early to mid-August; the yellow midge in April; and the two-banded midge from March to May and again in October. The two-banded midge breeds more than 15 generations a year. In summer and autumn, it needs 14-20 d for a generation, while in winter and spring, 25-30 d are needed.

The injurious habits of larvae vary greatly in the four midges. The larvae of brown, green, and yellow midges like to crowd under water and usually damage underwater parts of *Azolla*. Most larvae of the two-banded midge adhere to the *Azolla* body and damage the entire plant. After incubation beneath *Azolla*, the larvae climb to the young buds and chew the young leaves. After emergence, the adults mate in the present light.

Table 4. Six conventional insecticides and a bioinsecticide effective as a spray against the two *Pyralid* sp.

Insecticide	Formulation	Diluted times (w/v)	Mortality (%)	Target pest
Fenthion (MPP, Baycid)	50%EC	800	89.1	Snout moth
Cartap (Padan)	50%SP	1000	99.5	Grey snout moth
<i>Bacillus thuringiensis</i> var. <i>galleriae</i>		100	90.8	Grey snout moth
Fenitrothion (Sumithion)	50%EC	1000	86.9	Grey snout moth
Malathion (Malathion)	50WEC	800	71.4	Grey snout moth
Trichlorphon (dipterex)	90%SP	1000	57.2	Grey snout moth
Phosmet (PMP)	25%WP	1000	90.0	Snout moth

From Soil and Fertilizer Research Institute of Kwantong Agricultural Science Academy, 1976.

Besides insecticide application, drainage, alternate drainage and irrigation, wet-field or thin-layer water cultivation, and reduced application of organic manure, especially N-rich manure, effectively suppress the emergence and development of midges.

Spraying fenthion 50% EC of fenitrothion 50% SP dilute water solutions (1:800) showed some effect on the midge larvae. Carbofuran achieved more than 90% mortality of midge larvae when applied at rates of 37.5-52.5 kg 3% G or 0.112-1.575 kg ai/ha.

The *Azolla* snout moth produces 12 generations a year in Kwantong Province; its populations are high from May to August. The *Azolla* grey snout moth produces 14 generations a year; its population is high from June to September. The larval stages of the *Azolla* snout moth and the grey snout moth are long, and the larvae damage *Azolla* severely.

The living habits and damage caused by *Azolla* snout moth and the grey snout moth are principally the same. The larvae frequently damage *Azolla* at dusk, before dawn, on cloudy days, or postrainy days. Emergence, mating, and egg laying of adults are usually in the twilight, at midnight, or before dawn. Therefore, insecticides should be applied elastically in the young stages of larvae or in the prepupal stage. The best result is obtained if various insecticides are applied alternately at dusk.

Table 4 shows six conventional insecticides and one bioinsecticide effective against the *Azolla* grey snout moth.

REFERENCES CITED

1. Bai, K. 1983. Advances in studies on the sexual reproduction of Azolla. Bot. Res. 1:253-256.
2. Liu, C. 1979. Use of Azolla in rice production in China. Pages 375-394 in Nitrogen and rice. International Rice Research Institute, P.O. Box 933. Manila, Philippines.
3. Soil and Fertilizer Research Institute of Kwangtong Agricultural Science Academy. 1976. Comprehensive report of studying on utilization technique of cultivation and propagation in summer *Azolla*. Kwangtong Agric. Sci. 3:30-37.
4. Soil and Fertilizer Research Institute of Kwangtong Agricultural Science Academy. 1978. Preliminary report of studying on kinds of midges in Azolla, biological specifics of *Polypeditum iuinoense* and its control. Kwangtong Agric. Soil 5:43-15.
5. Soil and Fertilizer Research Institute of Zhejiang Agricultural Science Academy. 1975. Cultivation and utilization in Azolla. Agric. Press.
6. Shi, S., L. Cheng, H. Lin, C. Shu, and C. Wen. 1978. Effect of Azolla on the fertility of paddy soil. Acta Pedol. Sin. 15(1):54-60.
7. Wang, S. 1980. Utilization of Azolla in agriculture of China. J. Soil Sci. 6:45-47.

Azolla and its use in rice culture in West Africa

H.F. DIARA, H. VAN BRANDT, AND A.M. DIOP
West Africa Rice Development Association (WARDA)
B.P. 96, Saint Louis, Senegal

AND

C. VAN HOVE
Université Catholique de Louvain
Place Croix du Sud,4, B-1348
Louvain-la-Neuve, Belgium

WARDA has *Azolla* research projects in the semiarid Sahelian zone and in the humid tropic zone, primarily in its research stations in Senegal and Sierra Leone. Only one strain has been selected and multiplied for rice cultivation trials at each station. In northern Senegal, where farmers apply N at high rates, 120 kg N/ha, up to 50% of the mineral N can be supplied by *Azolla* N. In the mangrove swamps of Sierra Leone, *Azolla* N can completely replace mineral N at the recommended rate of 40 kg N/ha. *Azolla* has also been successful in weed control in irrigated rice. Typical results obtained from the two stations are presented. In both Senegal and Sierra Leone, there are difficult problems related to introducing the use of *Azolla* in farmers' fields. These problems were first evaluated in the Senegal River delta and valley where the multiple use of *Azolla* is being tested. Suggestions on the alternative uses of *Azolla* under these conditions are discussed.

The West Africa Rice Development Association (WARDA) is a regional organization of 16 member countries. Its main objective is to increase, quantitatively and qualitatively, rice production in all member countries to attain self-sufficiency as soon as possible. However, the often unfavorable climate during the past few years has caused production fluctuations and crop failures. In 1980 WARDA began a research program on *Azolla* and its possible application to rice cropping. The trials were conducted simultaneously in Richard Toll Fanaye Station (Senegal) under a semiarid climate and in Rokupr (Sierra Leone) under a wet humid climate. Only in the humid zone was *Azolla* (*A. pinnata* var. *pinnata*) found in nature, but local farmers did not

realize its potential in their fields. Some typical results obtained at the two stations are presented before discussing the major problems of introducing *Azolla* at the farm level under West African conditions.

MATERIAL AND METHODS

Adaptive trials and selection of strains

Eighty *Azolla* strains, representing all the species, have been introduced at the Richard Toll research station. In the beginning, only qualitative observations were made through simple visual inspection. Those resulted in the selection of one strain of *Azolla pinnata* var. *imbricata*, of Indian origin, in Richard Toll/Fanaye, and of another strain of *Azolla pinnata* var. *pinnata* of local origin in Rokupr. These strains were retained for all trials in ricefields until recently (5).

AMOUNT OF INOCULUM AND GROWTH OF AZOLLA IN RICEFIELDS

In preliminary trials, *Azolla*, initially inoculated at 0.2 kg/m², covered the ricefield completely in 15-20 d. Presently, to get a quicker cover, the amount of inoculum has been increased to 0.5 kg/m². Based on International Rice Research Institute recommendation (1), P is applied in split applications of 5 kg P₂O₅/ha, every 5 d.

EFFECT OF AZOLLA ON RICE YIELDS

In Fanaye, 1 trial was conducted in the hot dry season using the rice variety Srimalaysia, transplanted at 20 × 20 cm spacing. The treatments, with 3 replication, were 1) control (0 N), 2) incorporation of 1 or 2 *Azolla* crops before transplanting, 3) incorporation of 2 *Azolla* crops before and 2 *Azolla* crops after transplanting, and 4) application of 30, 60, and 120 kg N/ha as urea alone or in combination with *Azolla* incorporated before transplanting. In Rokupr, a trial was conducted during the rainy season using variety Rok 5 in an associated mangrove swamp. The effect of 40 t *Azolla* fresh wt/ha, incorporated entirely 2 wk before transplanting, was compared to the recommended dose of 40 kg N/ha as urea and the control. Incorporation was by foot in Fanaye and with the traditional hoe in Rokupr.

EFFECT OF AZOLLA ON WEED DEVELOPMENT

One trial was conducted in the humid season in Fanaye, to assess the weed-suppressing capacity of an *Azolla* cover associated with rice compared to more traditional weeding methods. The rice variety Srimalaysia was transplanted at 25 × 25 cm spacing. All treatments received NPK application at 120, 60, and 60 kg/ha. *Azolla* was inoculated at 0.5 kg/m² 5 d after transplanting. Treatments included 1 manual weeding 3 wk after transplanting, 2 manual

weedings 3 and 6 wk after transplanting, and 1 application of bentazon at 8 liters/ha 15 d after transplanting. Each treatment, including the control plot, was replicated once with *Azolla* covering the floodwater. Weed dry wt/m² was measured 25 and 45 d after transplanting.

RESULTS AND DISCUSSION

With an *Azolla* inoculum at 0.5 kg/m², an *Azolla* monocrop will cover the floodwater in 7-15 d, depending on the season and the site. The strain used in Richard Toll/Fanaye produced more when grown as a monocrop than when grown with rice, notwithstanding the high light intensities usual in the region. When dual cropped with rice, *Azolla* decreases proportionately to the rice canopy development. More information on the depressive effect of high light intensities on *Azolla* growth is needed. Table 1 shows the results of a fertilization trial in Fanaye. The *Azolla*-urea combinations yielded systematically better than *Azolla* alone. One incorporated *Azolla* monocrop is equivalent to 30 kg N/ha as mineral fertilizer. Two *Azolla* crops incorporated after transplanting are insufficient to make up for the lack of mineral N at the critical stages of the growth cycle of the rice plant, but probably have a positive residual effect on the next crop. The results obtained in Rokupr (Table 2) show that 2 crops of *Azolla* yield as much as the recommended dose of 40 kg N/ha split incorporation; 1 before and 1 after transplanting is perhaps more favorable. The positive effect of an *Azolla* crop on weed suppression has been investigated (2, 4). Results of the Fanaye trials (Table 3) confirm those observations. Except for chemical weed control, the *Azolla* crop always increases yield compared to treatments without *Azolla*. The extra yield of 1.7 t/ha is itself a significant demonstration of weed control without manual weeding.

Table 1. Effects of *Azolla pinnata* (strain ADUL-7) applied alone or in combination with urea at variable doses, on the grain yield of rice variety Srimalaysia. 1983 dry season, Fanaye, Senegal.

Treatment ^a	Grain yield (t/ha)	Increase over control	
		t/ha	%
60 kg N (urea)/ha + 2 <i>Azolla</i> crops BT	8.0 a	5.2	191
120 kg N (urea)/ha	7.2 a	4.4	162
Two <i>Azolla</i> crops BT + 2 <i>Azolla</i> crops AT	5.9 b	3.1	114
60 kg N (urea)/ha	5.6 bc	2.9	106
30 kg N (urea)/ha + 1 <i>Azolla</i> crop BT	4.8 cd	2.0	74
Two <i>Azolla</i> crops BT	4.5 cd	2.0	72
30 kg N (urea)/ha	4.4 d	1.6	60
One <i>Azolla</i> crop BT	3.9 d	1.2	43
<i>Azolla</i> as topdressing	3.9 d	1.2	43
Control (without N)	2.7 e	—	—

^a BT = incorporated before rice transplanting, AT = incorporated after rice transplanting.

Table 2. Effects of incorporated *Azolla* and mineral nitrogen on the yield of rice variety ROK 5 in an associated mangrove swamp in Rokupr, Sierra Leone, 1983.

Treatment ^a	Panicle per plant	Mean grain yield (t/ha)	Increase over control	
			t/ha	%
Control (without N)	7	2.2	-	-
40 kg N (urea)/ha	11	3.1	1.0	44
40 t <i>Azolla</i> fresh wt/ha BT	9	3.0	0.8	38
20 t <i>Azolla</i> fresh wt/ha BT + 20 t AT	11	3.2	1.1	53

^a BT = incorporated before rice transplanting, AT = incorporated after rice transplanting.

Table 3. Effects of weeding method and *Azolla* cropping on the weed development and yield of the rice variety Srimalaysia. 1983 humid season, Fanaye, Senegal.

Treatment	Weed dry wt (g/m ²)		Grain yield ^a (t/ha)
	25 DT	45 DT	
1. Control (without weeding)	129.3	213.7	4.2 c
2. Manual weeding 3 wk after transplanting	0.5	0.5	7.0 ab
3. Manual weeding 3 and 6 wk after transplanting	0.6	3.9	6.6 ab
4. Basagran P1 at 8 liters/ha 15 d after transplanting(DT)	12.8	2.9	6.9 ab
5. Treatment 1 + <i>Azolla</i>	20.0	40.3	5.9 b
6. Treatment 2 + <i>Azolla</i>	0.0	2.6	7.5 a
7. Treatment 3 + <i>Azolla</i>	0.3	0.1	7.2 ab
8. Treatment 4 + <i>Azolla</i>	0.1	0.3	6.9 ab

^a Means followed by the same letter are not significantly different at 5% level by DMRT.

AZOLLA ADOPTION BY WEST AFRICAN FARMERS

Azolla introduction trials in farmers' fields have been mainly initiated in the delta area and on the left bank in the middle valley of the Senegal River.

Socioeconomic context

Most rice cropping in the Senegal River delta takes place in large irrigation systems where most of the mechanization and chemical inputs are supplied by a national development company, which subsidizes these services. With some exceptions, most of the rice in the middle valley is grown in smaller village irrigation systems developed by the farmers themselves with a minimum of technical and material assistance. Village farmers are much more involved in the cropping system than farmers in the larger systems, who are reluctant to change their cultural methods when the change requires labor.

Main constraints to *Azolla* adoption by Sahelian farmers

All water for rice and *Azolla* cropping has to be pumped from the river. One hectare consumes roughly 100 m³/d at a price of US\$0.01/m³. Assuming that 1 ha of *Azolla* grown during 15 d replaces about 30 kg N/ha, this gives a price of about \$0.50/kg N. That cost does not reflect additional labor involved in producing *Azolla*, which could easily double that cost. Even after the recent price increases of chemical fertilizers, the nonsubsidized prices for N on the local market is only about \$0.92/kg. Even if prices were competitive, water is available only 1 or 2 wk before optimal rice sowing days. It seems unrealistic now to adopt the traditional Vietnamese or Chinese technique of growing one *Azolla* crop before the rice crop in the delta and the middle valley of the Senegal River (3, 4). Two dams under construction on the Senegal River could, however, change the situation when fresh water would be available in quantities required at the proper time.

Trial strategies for introducing *Azolla*

Azolla production and use have been worked out to minimize dependence on expensive pumped water.

Dual cropping Azolla with rice. Dual cropping *Azolla* with rice can be implemented easily where rice is transplanted and water is available to continuously flood the fields. That condition is, however, an exception in the region. In most large systems in which water is generally assured, farmers direct-seed pregerminated seeds and spray herbicides 3 wk after sowing (WS) on the drained field. *Azolla* could be inoculated only after reflooding the field. The beneficial effects of intercropped *Azolla* in this system could only be residual or serve as weed control for the current crop. Information about residual effects of *Azolla* is not yet well documented. For weed suppression, a quick cover is needed and a massive inoculation is required. In the village irrigation systems, transplanting is widely practiced, but soils are more permeable and water is more limited. Most of the areas are without standing water for several days, especially during the first weeks of cropping. This intermittent flooding is incompatible with *Azolla* cropping. This situation requires taking advantage of other techniques such as composting or growing *Azolla* in natural reservoirs or areas flooded by waste or drain water.

Azolla cropping out of the ricefields. Near most of the rice areas, there are natural depressions flooded by rainwater during the short humid season or by the drain water of the larger systems. All of these bodies of water could be inoculated with *Azolla*, which could be composted, and used fresh or dried or as fodder. Some constraints have been experienced in early trials. The wind accumulates the *Azolla* cover in corners. Some aquatic weeds such as *Eichhornia* sp. were successfully used as fences to counteract effects of wind action. In large systems *Azolla* grows successfully in drains, which are well protected by dikes. Algae, *Eichhornia* sp., *Nymphaea* sp., and *Marsilea quadrifolia* are the most common weeds competing with *Azolla*. When composting is done, the weeds will be harvested first. Growing *Azolla* out of

the ricefields means that the green manure must be harvested regularly to maintain optimum growing conditions (6). We have tried to locate simple harvesting tools that are readily available at the village level. On large water bodies, 15-mm-mesh wire nets (4 m long, 1 m wide) can be manipulated efficiently by 2 persons. *Azolla* introduction has been tried recently in other West African countries where the socioeconomic context, soils, climate, and technology level are fundamentally different.

REFERENCES CITED

1. International Rice Research Institute, International Network on Soil Fertility and Fertilizer Evaluation for Rice. 1983. Revised report on fourth trial on *Azolla* use in rice 1982. P.O. Box 933, Manila, Philippines. 12 p.
2. Janiya, J.D., and K. Moody. 1986. Weed suppression in transplanted rice with *Azolla pinnata* R. Br. *Int. Pest Control* 23(5):136-137.
3. Liu Chung Chu. 1979. Use of *Azolla* in rice production in China Pages 375-394 in Nitrogen and rice. International Rice Research Institute, P.O. Box 933, Manila, Philippines.
4. Lumpkin, T.A., and D.L. Plucknett. 1982. *Azolla* as a green manure: use and management in crop production. Westview Press, Boulder, Colorado. 230 p.
5. Van Hove, C., T. de Waha Baillonville, H.F. Diara, P. Godard, T. Mai Kodomi, and N. Sanginga. 1987. *Azolla* collection and selection. Pages 77-87 in *Azolla* utilization. International Rice Research Institute, P.O. Box 933, Manila, Philippines.
6. Van Hove, C., H. F. Diara, and P. Godard. 1983. *Azolla* in West Africa [French and English]. West Africa Rice Development Association, Monrovia. 53 p.

DISCUSSION

KANNAIYAN: The *Azolla* strain that you use seems to be more adaptable at high temperature. Do you get any disease problems in the *Azolla pinnata* strain that you use?

DIARA: We have not experienced any disease problems, probably because of the dry climate in the North of Senegal. I noticed some fungus attack in Sierra Leone, but not much. I do not know if it will spread.

Use and importance of *Azolla-Anabaena* in industrial countries

H.W. SCHARPENSEEL AND K. KNUTH

Department of Soil Science

University of Hamburg

Allendeplatz 2, D-2000, Hamburg 13

Federal Republic of Germany

Azolla work in major industrial countries is briefly described. The discussion is limited to descriptions of major project areas and working groups. Work in the authors' own institute is described in somewhat more detail, but that does not constitute an expression of the relative importance of their work compared to that in other industrial countries. General investigations described include chemical constitution in relation to time of harvest, type of growth medium, doubling time under different regimes, and effect of different growth media on harvest time. Specific studies on mass production of *Azolla* in various concentrations of sewage solution, pot and field experiments with *Azolla* compost, and the suitability of *Azolla* and *Azolla* hay for animal feed are also discussed.

According to the map prepared by Lumpkin and Plucknett (18; also in [13]), *Azolla* ecotypes found in present-day industrial countries belong preferentially to the species *A. filiculoides*, *A. caroliniana*, and in the western U.S., *A. mexicana*. In the more tropical and subtropical industrial countries such as Japan, Korea, Australia, and India, *A. pinnata* is the dominant species. Lumpkin and Plucknett (18) have compiled a complete record of the worldwide distribution of *Azolla* species based on literature primarily from botanists and ecologists.

Although *Azolla* was described (9,22) nearly 150 yr ago, it is only in the past 20 yr that the morphology, genetics, and biochemistry of the diazotrophic *Azolla-Anabaena* system have been meticulously studied. The numerous contributions of G.A. Peters and his coworkers (e.g., 24) of the Kettering Research Laboratory, Yellow Springs, Ohio, are representative of such studies. Beginning in the mid-1970s, I. Watanabe's research at the International Rice Research Institute (IRRI) in Los Baños, Philippines, turned attention to the practical use of *Azolla*. Lumpkin and Plucknett (18,9)

provided a complete overview of the state of the art as well as base literature so badly needed in the early 1980s. In 1983, Khan (13) published a practical illustrated primer on *Azolla* production and utilization in agriculture. Roger and Reynaud (31) characterized *A. africana*, which was later determined part of the species *A. pinnata* (17). All of these efforts were directed toward assessing the potential of *Azolla* as a N source in rice culture. There have been many approaches and pioneering trials on the utilization of *Azolla* for various purposes. They have been described in detail by Lumpkin and Plucknett (18,19). The following applications of *Azolla* have been suggested or explored.

- producing compost with a rich, more constantly releasable supply of plant available N;
- timing *Azolla* mats to control weeds (The *Azolla* blanket must be sufficiently developed to suppress weed growth, but limited enough to avoid damaging rice seedlings.);
- extracting P from eutrophicated water, with *Azolla* green manure or compost as a by-product;
- utilizing nutrients of sewage solutions to grow *Azolla* with green manure or compost as a by-product;
- absorbing heavy metals from polluted media;
- testing the degree of contamination of wet soil or water by environmental chemicals;
- narrowing the C:N ratio in park lakes to achieve better decomposition of leaf and needle droppings from park trees;
- feeding livestock, poultry, and fish;
- inhibiting mosquito proliferation; and
- including *Azolla* in human diets.

USA

Most *Azolla* studies, including those related to submerged soils and rice culture and to other applications, have probably been reported from U.S. institutions, especially the University of California, Davis. An overview of *Azolla* is given by Rains and Talley (30), other uses of *Azolla* by Lumpkin and Plucknett (18, 19), *Azolla* for human nutrition by Buckingham et al (7), *Azolla* in *Tilapia* fish culture by Lasher (16), *Azolla* for silage and taro production by some working groups at the University of Hawaii, as cited by Lumpkin and Plucknett (19), *Azolla* for weed control by Talley et al (37), and *Azolla* for mosquito control by Smith (34). Environmental assessment has been done by Keeney (12) and Shaumuyan (33). *Azolla* in genetic engineering is dealt with by Lamborg (14) and the physiological/biochemical aspects of *Azolla* utilization are reviewed by Peters et al, cited by Lumpkin and Plucknett (19). At the 1984 American Society of Agronomy Conference, Reddy reported N_2 fixation rates obtained by *Azolla* cultured in waste waters of Florida. The rational use of: *Azolla-Anabaena* for N nutrition of rice plants in submerged soils has been thoroughly reviewed and investigated (8, 10, 23, 29, 30, 35, 36, 37).

United Kingdom

In the United Kingdom, *Azolla* studies have been approached from a rather fundamental viewpoint such as Postgate's work on *Azolla* association (26) and *Azolla* physiology (27); La Rue's deliberations on chemical and biological nitrogen fixation (15); Steward's research in Dundee University, Witty's isotope dilution techniques on the contribution of fixed N to the rice nutritional system; and Lee's enzyme work, for example, on glutamine synthetase in *Azolla* (all cited by K.E. Giller, Rothamsted, Dept. of Soil Microbiology, 1984, pers. comm.) Marten's (20) *Azolla* work is geared to energy conservation.

Japan

Azolla culture is rarely practiced in Japan because it is uneconomical. This includes *Azolla* as a N source for rice production, as an animal feed, or as an antipollutant - *Eichhornia* is preferred and considered more effective (M. Yatazawa, Faculty of Agriculture, Chikusa, Nagoya, Japan, 1984, pers. comm.). Comparative studies on plant production in space stations show that the *Azolla pinnata*-*Anabaena* system is more efficient than any of the other tested diazotrophs such as free-living blue-green algae or soybean or groundnut *Rhizobium* (38).

France

Azolla has long been known in France because it is ubiquitous in Vietnamese rivers, lakes, ponds, and ricefields. Ecological studies regarding *Azolla africana*, which according to Lebrun (17) must be considered a variety of *Azolla pinnata*, have been carried out by Roger and Reynaud (31). At present *Azolla* apparently is not being directly used or studied in France (R. Fauck, 1984, pers. comm.).

The Netherlands

In The Netherlands basic physiologic and soil/plant biochemical studies, especially of *A. pinnata*, have been conducted since the early 1970s (6). A general study of *Azolla* occurrence in The Netherlands was done by Pieterse et al (25). The N fertilizer effect is not considered of special importance and *Azolla* is considered a weed in the polder ditches, blocking the flow of water and depriving it of O₂. Ackermans (1), describing N₂ fixation in non-leguminous systems, concentrated his work on the acetylene reduction activity of *Azolla* in polder ditches.

Austria

As a consequence of recommendations by a consultants' meeting in 1982, the Agricultural Biotechnical Laboratory of the FAO/International Atomic Energy Agency in Vienna-Seibersdorf has done ¹⁵N-labeled studies with *A. caroliniana* and *A. pinnata* to determine the availability of *Azolla* N to rice and to compare N₂ fixation by *Azolla* to nondiazotrophic aquatic plants such as *Salvinia* and *Lemna*. Field experiments in Hungary showed 80-90% total N

was supplied by fixation as well as a superior N use efficiency of *Azolla* N compared with urea N.

South Africa

N₂ fixed by summer blooms of *Anabaena circinalis* in a low N impoundment of Rietvlei dam was measured by Ashton (2). N₂ fixed by 3 summer blooms amounted to 1.2–24.5 t and the annual contribution of fixed N₂, compared with total annual N₂ inflow, varied between 1.4 and 46.5%. Ammonification and nitrification seem to cause production of large amounts of inorganic N from organic material. The extent of Ndff increases with low N₂ concentration and high water temperature.

Germany

A variety of *A. filiculoides* from the German Democratic Republic has promising cold tolerance and is being studied in the IRRI *Azolla* program.

At the Soils Institute of Hamburg University, another *A. filiculoides* and an *A. caroliniana* variety have been investigated in 10 × 45 mm basins of an abandoned sewage plant and in the field. Because the *A. filiculoides* ecotype proved superior in mass production, constraint resistance, and overwintering, it has been chosen for many experiments.

Effect of harvest time on chemical concentration. *Azolla* mats harvested monthly between July and November from the same pond decreased slightly in mass. Although the cations (Ca²⁺, Mg²⁺, K⁺) of aqueous extracts showed a slight increase in meq/kg, Na decreased from July to November (Table 1). Anions, such as PO₄³⁻, SO₄²⁻, Cl⁻, C₂O₄H₂, or unidentified fatty acids decreased, but NO₃⁻ did not show a distinct trend (Table 2). Carbon content

Table 1. Cation concentrations in aqueous extracts of *Azolla* samples harvested at different periods in 1981.

Harvest period	Cation (g/kg)				Total (meq/kg)	Cation(%)			
	Ca	Mg	K	Na		Ca	Mg	K	Na
Jul	0.36	1.44	17.3	17.6	1344.41	1.3	8.8	32.9	56.9
Aug	0.27	1.36	19.8	17.8	1405.97	1.0	8.0	36.0	55.1
Sep	0.40	1.76	16.2	15.4	1248.90	1.6	11.6	33.2	53.6
Oct	0.68	1.84	16.1	15.0	1249.50	2.7	12.1	33.0	52.2
Nov	0.68	1.25	13.8	10.4	942.06	3.6	10.9	37.5	48.0

Table 2. Anion concentration in aqueous extracts of *Azolla* samples harvested at different periods in 1981 (FA peak of undifferentiated fatty acids, cumulatively presented by anion chromatograph).

Harvest period	Anion (g/kg)				Total (mmol/kg)	C ₂ O ₄ H ₂ (mm)	FA (mm)
	NO ₃	PO ₄	SO ₄	Cl			
Jul	0.8	11.1	7.2	13.4	581.37	15.0	65.0
Aug	0.8	10.8	6.6	13.3	570.94	19.0	28.0
Sep	0.7	5.5	4.7	12.4	465.92	14.0	23.0
Oct	1.0	9.5	4.2	9.1	369.60	7.0	22.0

increased from July to November, while N and P contents slightly decreased (Table 3). Correspondingly, C:N and C:P ratios increased toward November, while N:P ratios were more erratic. The same holds true for the water-soluble percentage of total N and P. Proline content, regarded as a possible stress indicator, increased sharply from July to October. Total concentrations of metallic elements, including the heavy metals, showed no steady trend, except for Na, which decreased markedly from July to November (Table 4).

Effect of nutrient solution on chemical concentration. A N-free modified Hoagland solution, Watanabe N-free nutrient solution (pH 5.6, diluted 1:1 with water), rainwater + 50 ppm P, and rainwater + 10%, 20%, or 25% sewage solution were compared for their effect on chemical concentration in cultured *A. filiculoides*. Water-soluble cations showed erratic individual concentrations (Table 5). Water-soluble anions, such as NO_3^- , SO_4^{2-} , and PO_4^{3-} , were lower

Table 3. Total C, N, and P contents; water-soluble N and P concentrations; C:N, N:P, and C:P ratios; and proline content of harvested *Azolla* samples, 1981.

Harvest month	Total N (%)	Soluble N (% of total N)	Total P (%)	Soluble P (% of total P)	Total C (%)	S:P	C:N	C:P	Proline ($\mu\text{g/g dry wt}$)
Jul	5.11	35	0.47	77	45.1	10.9	8.8	96.4	2.50
Aug	4.10	44	0.49	72	45.5	8.4	11.1	93.4	2.50
Sep	4.34	34	0.40	45	48.7	10.7	11.2	120.5	30.0
Oct	1.02	54	0.38	82	51.3	10.7	12.8	136.4	50.0
Nov	3.27	37	0.39	48	54.1	8.3	16.5	138.0	20.0

Table 4. Total element concentration, including heavy metals, dependent on harvest time, July-November 1981, relative to dry matter.

Harvest month	Element (ppm)											
	Na	K	Ca	Fe	Cu	Mn	Zn	Cr	Ni	Cd	Pb	Hg
Jul	17188	14583	9844	1957	34.1	1448	140	1.90	4.8	0.85	28.8	0.13
Aug	15825	18008	6166	1599	25.3	1408	60	4.33	12.1	0.44	10.0	0.05
Sep	14635	13551	9052	1870	27.0	965	69	1.73	4.0	0.61	18.7	0.17
Oct	14891	15387	7098	2023	28.1	1052	133	5.21	6.0	0.40	22.1	0.19
Nov	11983	15251	10240	707	26.5	360	168	0.86	5.9	0.71	21.2	0.18

Table 5. Cation concentration in aqueous extracts of *Azolla* samples harvested in November from different basins, with and without sewage.

Treatment medium	Cation (g/kg)				Total (meq/kg)	Cation (%)			
	Ca	Mg	K	Na		Ca	Me	K	Sa
N-free modified Hoagland solution	0.50	1.26	18.4	7.2	912.35	2.7	11.4	51.6	34.3
Nutrient-solution n. Watanabe (1:1) pH 5.6	0.47	1.41	22.3	7.5	1035.98	2.3	11.2	55.0	31.5
Rainwater + 50 ppm P <i>Azolla</i> plus <i>Lemna</i>	1.26	1.82	27.7	6.5	1203.73	5.2	12.4	58.9	23.5
Rainwater plus 10% sewage solution	0.98	1.66	7.7	11.8	895.65	5.5	15.2	22.0	57.3
Rainwater plus 20% sewage solution	0.63	1.04	6.2	16.5	993.25	3.2	8.6	16.0	72.3
Rainwater plus 25% sewage solution	1.07	3.08	9.7	9.5	968.06	5.5	26.2	25.6	42.7

in dilute sewage solution media than in ordinary nutrient solutions. High Ca^{2+} , Mg^{2+} , K^+ , NO_3^- , SO_4^{2-} , and PO_4^{3-} values are associated with *Azolla* plus *Lemna* mats (Table 6). Total C, N, and P concentrations as well as C:N, C:P, and N:P ratios were systematically lower in P, C:P and N:P were higher in sewage solutions (Table 7). The percentage of water-soluble P compared with total P decreased at higher sewage levels. Proline content was extremely low in the *Azolla/Lemna* culture, indicating that *Azolla/Lemna* was least affected by P deficiency. Total concentrations of K, Ca, and Fe were characteristically low in *Azolla* grown in sewage solution (Table 8). For all other metallic elements, including the heavy metals, the concentration pattern is erratic. *Azolla* plus *Lemna* had the highest concentrations of K, Ca, Mn, Zn, and Ni.

Mass production in different growth media. Mass production of *A. filiculoides* and mass doubling period were monitored with different sewage

Table 6. Anion concentration in aqueous extracts of *Azolla* samples harvested in November from different basins, with and without sewage. FA = peak of undifferentiated lower fatty acids cumulatively indicated by anion chromatograph.

Treatment medium	Anion (g/kg)				Total (mmol/kg)	$\text{C}_2\text{O}_4\text{H}_2$ (mm)	FA (mm)
	NO_3^-	PO_4^{3-}	SO_4^{2-}	Cl^-			
N-free modified Hoagland solution	0.3	9.1	7.1	8.9	426.20	4.0	22.0
Nutrient solution according to Watanabe (1:1) pH 5.6	0.5	9.6	6.0	9.3	432.06	9.0	36.0
Rainwater + 50 ppm P <i>Azolla</i> plus <i>Lemna</i>	1.1	18.9	11.5	7.1	535.21	10.0	29.0
Rainwater plus 10% sewage solution	0.3	3.7	4.8	9.6	365.06	13.0	52.0
Rainwater plus 20% sewage solution	0.4	3.1	5.0	9.1	347.37	10.0	24.0
Rainwater plus 25% sewage solution	0.4	2.4	8.3	9.9	398.41	9.0	14.0

Table 7. Total C, N, and P, water-soluble N and P concentrations, and proline content of harvested *Azolla* samples, with and without sewage.

Treatment medium	Total N (%)	Soluble N (% of total N)	Total P (%)	Soluble P (% of total P)	Total C	N:P	CN	C:P	Proline ($\mu\text{g/g}$ dry wt)
	N-free modified Hoagland solution	4.10	19	0.504	59	54.1	8.1	13.4	108.9
Nutrient solution acc. to Watanabe (1:1), pH 5.6	3.60	31	0.526	60	41.3	6.8	11.8	80.4	50.0
Rainwater + 50 ppm P <i>Azolla</i> plus <i>Lemna</i>	2.47	100	0.837	74	43.3	3.0	17.5	51.7	2.5
Rainwater plus 10% sewage solution	3.39	21	0.186	65	47.0	18.2	13.9	252.7	30.0
Rainwater plus 20% sewage solution	3.56	24	0.214	47	47.7	16.6	13.4	222.9	70.0
Rainwater plus 25% sewage solution	2.92	31	0.206	38	52.6	14.2	18.0	255.3	35.0

concentrations in large (45 × 5 m) concrete basins, and with Watanabe nutrient solution in small (220 × 120 cm) plastic basins. Doubling period was 3.75-4 d in Watanabe nutrient solution and 7.5-8.25 d in sewage concentrations (Table 9). The longer doubling time in sewage concentrations was mainly due to overaging of the plants and delayed harvest. In other tests in 220 × 120 cm basins, doubling period was 3.8-4.8 d from June to August, but rose to 7 d in September with shorter daylength and lower temperature (Table 10).

Perennial production in sewage solution. Two concrete basins 45 × 10 m and one 20 × 5 m were filled to about 30 cm depth with rainwater, which was adjusted with filtered sewage solution to about 20-25% concentration. *Azolla* plants were inoculated 28 Jul at 300 g/basin. Plants in one basin that was cleaned after harvesting *Azolla* the previous year did not proliferate and had to

Table 8. Total element concentrations, including heavy metals, in harvested *Azolla* samples, with and without sewage.

Treatment medium	Element (ppm)											
	Na	K	Ca	Fe	Cu	Mn	Zn	Cr	Si	Cd	Pb	Hg
N-free modified Hoagland solution	7416	16952	4556	520	26.4	49	77	2.8	4.0	0.57	30.0	0.10
Nutrient solution according to Watanabe (1:1), pH 5.6	8820	24991	2548	245	16.9	46	44	2.9	2.3	0.31	13.5	0.09
Rainwater + 50 ppm P, <i>Azolla</i> plus <i>Lemna</i>	6452	26345	14248	497	15.1	785	569	1.2	15.3	0.81	10.2	0.02
Rainwater plus 10% sewage solution	11568	6610	5674	165	23.6	74	37	2.2	5.8	1.10	21.0	0.16
Rainwater plus 20% sewage solution	15884	5295	7201	224	22.3	67	126	0.7	3.1	0.96	12.4	0.13
Rainwater plus 25% sewage solution	8240	8789	6098	233	19.5	60	57	0.9	4.1	0.69	13.0	0.10

Table 9. *Azolla* growth in concrete and plastic basins with dilute sewage solution or Watanabe nutrient solution (N-free).

Growth medium	<i>Azolla</i> input (kg fresh wt) in 5 × 45-m basin	Harvested <i>Azolla</i> (kg fresh wt)	Growth period (d)	Doubling period (d)
3% sewage	4.55	890.80	62	8.25
6% sewage	4.70	1049.70	62	8.0
12.5% sewage	4.10	1081.80	61	7.5
25% sewage	4.50	1178.30	61	7.5
Watanabe nutrient solution in smaller plastic basins	0.58	7.90	14	3.75
Same system	0.51	6.50	14	4.0

Table 10. Doubling period of *Azolla filiculoides* under Hamburg climate, 1982.

Date of inoculation	Growth period (d)	<i>Azolla</i> inoculated (d)	<i>Azolla</i> harvested (g)	Doubling period (d)
8 Jul	14	100	1362	3.8
8 Jul	14	100	1275	3.9
8 Jul	14	100	1873	3.4
29 Jul	14	100	879	4.5
29 Jul	14	100	1175	4.0
25 Aug	14	100	757	4.8
8 Sep	14	100	403	6.9
8 Sep	14	100	400	7.0

Table 11. *Azolla* production in sewage solution and as a perennial system.

Basin size	<i>Azolla</i> inoculated (g)	<i>Azolla</i> harvested ^a (kg)	C:N	N:P
20 × 5 m	1250	378.8	11.6	3.9
45 × 10 m	Perennial	1757.7	11.9	3.0
45 × 10 m	Perennial	929.2	11.3	3.2

^aHarvested on 29 Sep.

be reinoculated on 18 Aug. In the two other basins, however, a new *Azolla* generation grew from overwintering spores, which shows that even under the Hamburg climate (53°30'N) natural reproduction can be achieved. Harvested amounts and chemical characteristics are given in Table 11.

Growth response to increasing concentrations of sewage solution. *Azolla* growth response to increasing concentrations of sewage solution was monitored over four harvests during the annual growth period in 1983. The individual growth medium was added only once and *Azolla* was inoculated in equal amounts. *Azolla* growth in the control (low N nutrient solution) began slowly, but yielded highest at the fourth harvest (Table 12). *Azolla* growth in the high sewage concentrations was very poor at the first two harvests, but improved in the last two (October and November). Yields from the low concentration sewage solutions declined, probably because of lack of nutrients. A sewage solution concentration of 20% seems optimal for yield performance.

Azolla as a N source vs mineral fertilizer. The N effect of mineral fertilizer was compared with that of *Azolla* compost on salad plants grown in Mitscherlich pots with soil of Dystrochrept, Bv-horizon, 0.03% N. The pots were adequately supplied with P, K, and minor elements. The amounts of added fertilizer N or *Azolla* compost were not identical. Plants in pots with mineral N developed quickly and yielded highest in the first harvest, but there was no yield advantage in the second harvest (Table 13). In the second harvest, plants in pots with high grade N compost cuttings yielded higher. At the third harvest all three treatments with *Azolla* plus mineral N yielded more than the treatment with fertilizer N alone.

Table 12. *Azolla* yields at different sewage concentrations over four harvests, showing relative yields for each harvest, total yields, and total yields for each treatment as a percentage of the control yield.

Sewage concentration (%)	Harvest date								Total yield _{control} (g)	% of
	18 Aug 83		15 Sep 83		13 Oct 83		11 Nov 83			
	Yield (g)	% of highest yield	Yield (g)	% of highest yield	Yield (g)	% of highest yield	Yield (g)	% of highest yield		
Control, low-N nutrient solution	62	18	1961	37	632	27	427	100	3082	100
10	345	100	3225	61	1212	51	253	59	5035	163
20	70	20	5330	100	2128	90	212	64	7800	253
30	40	12	2776	52	1295	55	326	76	4437	144
40	19	6	1552	29	1420	60	293	69	3284	107
50	4	1	829	16	1961	87	327	77	3121	101
60	dead	0	263	5	2370	100	345	81	2978	97
70	dead	0	261	5	1866	79	336	79	2463	80

Table 13. Comparative yields of salad plants fertilized with mineral N and *Azolla* compost N in a pot experiment, showing relative yields for each harvest, total yields, and total yields for each treatment as a percentage of the control yield.

Treatment	Harvest date						Total	
	4 Jul 83		31 Oct 83		12 Dec 83		Yield (g)	% of control
	Yield (g)	% of highest yield	Yield (g)	% of highest yield	Yield (g)	% of yield		
Control	21	13	19	14	19	39	59	100
1.3 g Leunasalpeter	156	100	75	56	25	51	256	434
10 g <i>Azolla</i> compost, ground	53	34	63	47	30	61	146	247
20 g <i>Azolla</i> compost, ground	79	51	80	60	38	78	197	334
10 g <i>Azolla</i> compost, cuttings	92	59	133	100	49	100	274	464

Table 14. Effect of *Azolla* as N source on cabbage, as compared with Kalkammonsalpeter ($\text{NH}_4\text{NO}_3 + \text{CaCO}_3$).

Treatment (equal N amounts)	Av wt of marketable heads of cabbage ^a (g)
Control, without N fertilizer	1087.50
Kalkammonsalpeter ($\text{NH}_4\text{NO}_3 + \text{CaCO}_3$) 150 g/4-m ² plot	1336.90
<i>Azolla</i> compost (<i>Azolla</i> growth on 1% sewage solution), 815 g dry matter/4-m ² plot	1200.00
<i>Azolla</i> compost (<i>Azolla</i> growth in Watanabe nutrient solution), 1399 g dry matter/4-m ² plot	1275.65
<i>Azolla/Lemna</i> compost (<i>Azolla</i> + <i>Lemna</i> growth in Watanabe nutrient solution) 774 g dry matter/4-m ² plot	1154.10

^a Calculated from 16 randomly harvested heads of cabbage.

Field experiments were conducted on the basis of equal N fertilization in an alluvial soil (Fluvent) of the Elbe River (Hamburger Gartenbau Versuchstation Ochsenwerder) with cabbage as the experimental plant. Because the soil still had 0.2% residual N, a moderate effect of fertilization remained—about 30% in the mineral fertilizer plots, about 20% in the *Azolla* compost plots, and about 15% in the *Azolla/Lemna* compost plots (Table 14).

Earthworm population in Azolla compost. Properly moistened *Azolla* compost diluted with sawdust was placed in 3 dark plastic bowls each supplied with 20 *Lumbricides* individuals. Compost samples were analyzed for C, N, and P after 6 and 12 mo. After 6 mo the number of *Lumbricides* had increased only about 10%. Apparently the conversion of *Azolla* into compost proceeds quickly and the material in the process of composting is not a favorable growth medium to support dynamic multiplication of earthworms. P and N contents of the earthworm-populated compost compared with earthworm-free controls were erratic. Research on *Azolla* compost is at an early stage and basic characterization of the process is required.

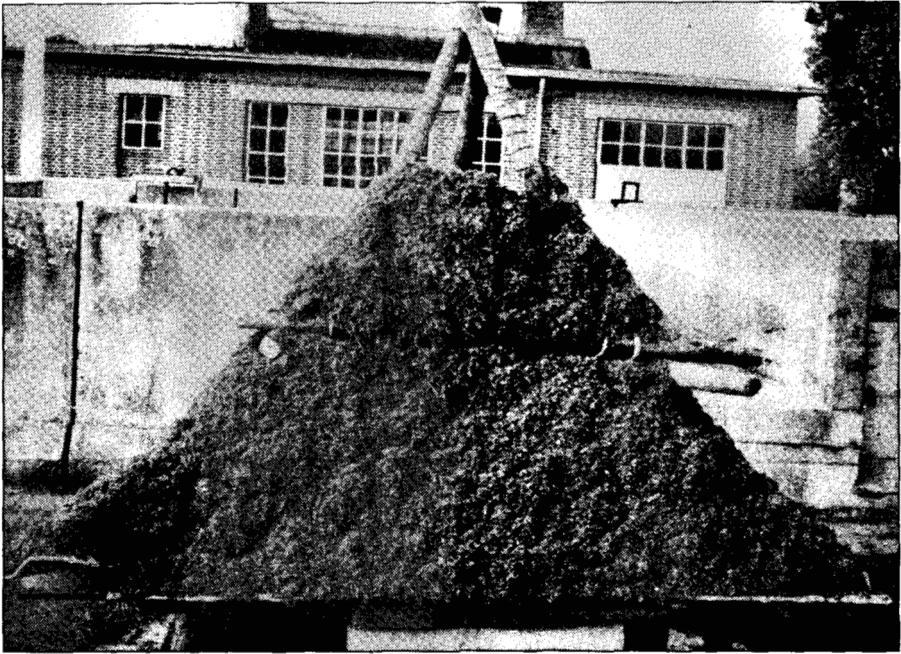

1. *Azolla* hay production on tripod supports.

Feeding value of A. filiculoides and use of Azolla as fodder. Feeding value of *Azolla* based on digestibility and ways of handling and preserving *Azolla* are key issues. Because of *Azolla*'s high moisture content (about 95%), complicated transport and storage are impracticable. Feeding trials with fresh *Azolla*, requiring transport of the forage from Hamburg to the Institute of Animal Nutrition, Stuttgart-Hohenheim, illustrated the problem. The *Azolla* forage molded and animals refused to eat it in commensurate rations (K.H. Menke, Institute of Animal Nutrition, University of Hohenheim, FRG, pers. comm.) The same thing happened to *Azolla* sundried in the Philippines and sent to Hohenheim by D. Haws of IRRI. Figure 1 shows an attempt to produce *Azolla* hay on tripod supports. The quality of *Azolla* hay was unsatisfactory due to excessive drying required because of low water permeability due to the waxy cuticula. In agreement with Buckingham's analysis (7), the amino acid composition of *Azolla* protein is well balanced with relatively high lysine, methionine, and cystine concentrations (Table 15). However, the high and promising crude protein content is of low digestibility (10-14%) (32). Total digestibility measured by the gas forming method amounted to only 50% (Table 16).

Affinity for heavy metals. The affinity of *Azolla* for individual heavy metals offered in the nutrient solution indicates that Cu, Ni, and Zn, in the same order of intensity, are incorporated much faster than Pb, Mn, and Hg

Table 15. Amino acid composition of the *Azolla* protein (g/16 g N).

Amino acid	Wentorf sample,		Wentorf sample,		Bergedorf sample,	
	Aug		Nov		Nov	
	%	Variance	%	Variance	%	Variance
Cystine ^a	1.48	0.06	1.92	0.31	1.42	0.12
Aspartic acid	8.72	0.25	8.68	0.48	8.17	0.41
Methionine ^a	1.59	0.10	1.48	0.08	1.40	0.02
Threonine	4.59	0.14	4.39	0.17	4.13	0.16
Serine	4.65	0.07	4.89	0.11	4.54	0.09
Glutamic acid	11.21	0.34	12.41	0.37	15.56	0.40
Proline						
Glycine	5.37	0.14	5.41	0.15	4.94	0.13
Alanine	5.97	0.14	5.79	0.14	5.33	0.13
Valine	5.84	0.20	5.59	0.22	5.35	0.13
Isoleucine	4.69	0.13	4.46	0.14	4.21	0.15
Leucine	8.18	0.10	7.85	0.13	7.30	0.11
Thyrosine	3.67	0.07	3.46	0.07	3.38	0.09
Phenylalanine	5.12	0.08	5.03	0.10	4.62	0.08
Lysine	5.50	0.11	5.54	0.10	5.31	0.10
Histidine	1.99	0.03	2.02	0.05	1.94	0.03
Arginine	5.84	0.05	5.54	0.05	5.38	0.06
NH ₃	2.49	0.55	2.57	0.50	2.78	0.43
Total	86.91		87.03		85.76	

^a Cystine is determined as cysteic acid, methionine as methioninsulfon.

Table 16. Feeding value of *Azolla*.

Nutrient	Amount (% of dry matter)			
	Wentorf sample, Aug	Wentorf sample, Nov	Bergedorf sample, Nov	Wentorf mixed sample
Ash, minerals	13.30	9.94	8.85	12.33
Crude protein	31.36	20.40	22.89	26.80
Crude fat	5.08	5.82	5.14	4.07
Crude fiber	12.20	15.61	21.81	17.29
<i>In vitro investigations</i>				
Gas formation (ml/24 h) ^a				13.6 0.7
Digestibility of organic matter (%) ^a				49.9
Energy turnover (mJ/kg per kg dry matter) ^a				5.91
Starch units/kg dry matter ^a				185
Protein decomposition in 8 h (% RDN) ^b				11.8
Protein decomposition in 12 h				10.2
Protein decomposition in 16 h				14.4
Protein decomposition in 24 h				11.4
Pepsin solubility of undecomposed protein (%) ^c				5

^a Determination and calculation of feed values according to Menke et al (21).

^b According to Raab (28). ^c According to Jilg (11), 48 h in pepsin-HCl-solution (0.4 g pepsin/l; 0.075 N HCl; 40°C).

(Fig. 2). Because Cu is toxic to algal development when it surpasses its optimum concentration as a nutritional trace element (maximum 2.0 ppm Cu) in the nutrient solution, the *Azolla* plants begin to deteriorate and have no

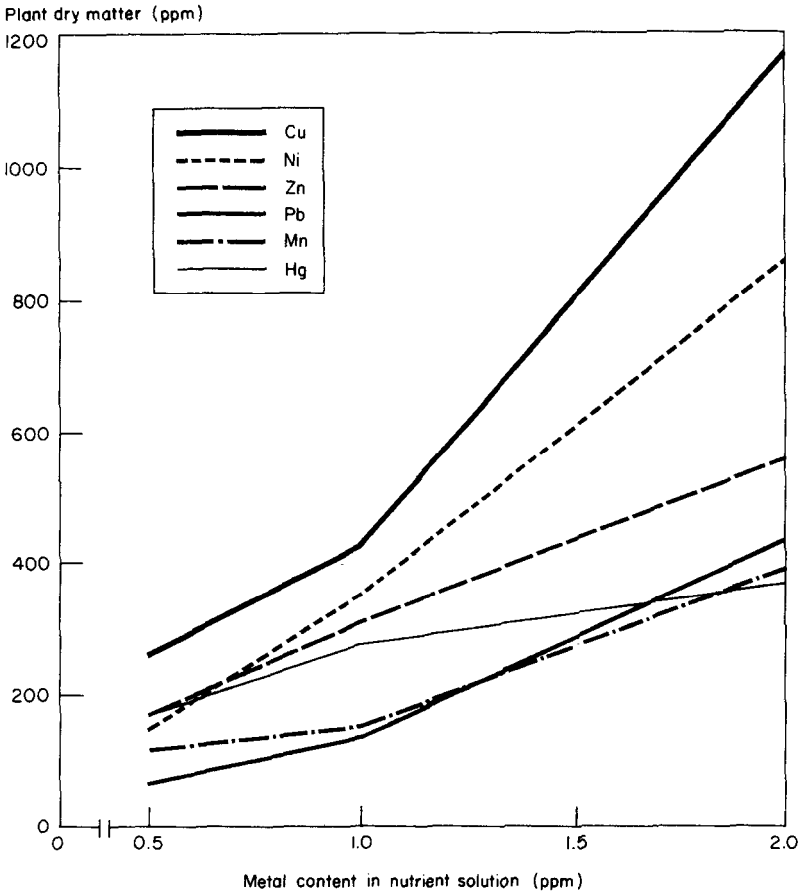

2. Heavy-metal contents in plant dry matter of *Azolla filiculoides* after 8-wk growth.

intact *Anabaena* symbiont. Plants with different levels of the other heavy metals appeared healthy over the entire concentration range. The tests were carried out with 10 g *Azolla* suspended in 36 × 24 cm plastic basins filled with N-free Hoagland solution and the heavy metal in acetate form.

REFERENCES CITED

1. Ackermans, A.D.L. 1978. Stikstofbinding in associaties met nietleguminosen. *Vakbl. Biol.* 58(5):82-89.
2. Asbton, P. J. 1981. Nitrogen fixation and the nitrogen budget of a eutrophic impoundment. *Water Res.* 15:823-833.
3. Becking, J.H. 1975. Nitrogen fixation in some naturalecosystems in Indonesia. Symbiotic nitrogen fixation in plants. P.S. Nutman, ed. International Biological Programme. Vol. 7. Cambridge University Press.
4. Becking, J.H. 1978. Ecology and physiological adaptations of *Anabaena* in the *Azolla-Anabaena azollae* symbiosis. Environmental role of nitrogen fixing blue-green algae and asymbiotic bacteria. *Ecol. Bull. (Stockholm)* 26:266-281.
5. Becking, J.H. 1979. Environmental requirements of *Azolla* for use in tropical rice production. Pages 345-373 in Nitrogen and rice. International Rice Research Institute, P.O. Box 933, Manila, Philippines.
6. Becking, J.H., and M. Donze. 1981. Pigment distribution and nitrogen fixation in *Anabaena azollae*. *Plant Soil* 61:203-226.
7. Buckingham, K.W., S.W. Ela, J.G. Morris, and C.R. Goldman. 1978. Nutritive value of the nitrogen fixing aquatic fern *Azolla filiculoides*. *J. Agric. Food Chem.* 26: 1230-1234.
8. Buresh, R.J., M.E. Casselman, and W.H. Patrick, Jr, 1980 Nitrogen fixation in flooded soil systems, a review. *Adv. Agron.* 33:149-192.
9. Griffith, W. 1845. On *Azolla* and *Salvinia*. *Calcutta J. Nat. Hist.* 5:227.
10. Hauck, R.D. 1981. Nitrogen fertilizer effects on nitrogen cycle processes. *Terrestrial Nitrogen Cycles* 551-562.
11. Jilg, T. 1982. Untersuchungen zum Proteinabbau im kunstlichen Pansen unter Berücksichtigung der Pepsin-HCl-Loslichkeit. Diplomarbeit, Fak. IV, Hohenheim, FRG.
12. Keeney, D.R. 1982. Nitrogen management for maximum efficiency and minimum pollution. Pages 605-649 in Nitrogen in agricultural soils. American Society of Agronomy, Madison, Wis.
13. Khan, M.M. 1983. Aprimeron *Azolla* production and utilization in agriculture. University of the Philippines at Los Baños, Laguna, Philippines. 143 p.
14. Lamborg, M.R. 1978. The role of blue-green algae enhancing crop production. Pages 56-60 in Report of the public meeting on genetic engineering for nitrogen fixation. Washington, D.C.
15. Larue, T.A. 1980. Chemical and biological nitrogen fixation. Pages 389-412 in Future sources of organic raw materials, CHEMRAWN I: invited lectures presented at the World Conference on Future Sources of Organic Raw Materials, Toronto. Oxford, Pergamon.
16. Lasher, C.W. 1967. *Tilapia mossambica* as a fish for aquatic weed control. *Prog. Fish Cult.* 29:48-50.
17. Lebrun, J.P. 1973. Enumeration des plantes vasculaires du Senegal. I.E.M.V.T. etude bot. 2. Maisons-Alfort, France. 209 p.
18. Lumpkin, T.A., and D.L. Plucknett. 1980. *Azolla*: botany, physiology, and use as a green manure. *Econ. Bot.* 34(2):111-153.
19. Lumpkin, T.A., and D.L. Plucknett. 1982. *Azolla* as a green manure: use and management in crop production. Westview Trap. Agric. Ser. 5.
20. Marten, N.W. 1981. Practical problems of energy saving and recycling in biological husbandry. *Biological Husbandry*, London. p. 135-144.
21. Menke, K.H., K. Raab, A. Salewski, H. Steingass, H. Fritz, and W. Schneider. 1979. The estimation of digestibility and metabolizable energy content of ruminant feeding stuffs from the gas production, when they are incubated with rumen liquor in vitro. *J. Agric. Sci., Cam.* 93:217-222.
22. Meyen, F.J.F. 1836. Beitrage zur Kenntnis der Azollen Soya Acta Leopold. Pt. 1. 18:507-524.
23. Patrick, W.H. 1982. Nitrogen transformations in submerged soils. Pages 449-465 in Nitrogen in agricultural soils. Madison, Wisconsin.

24. Peters, G.A., B.C. Mayne, T.B. Ray, and R.E. Toia, Jr. 1979. Physiology and biochemistry of the *Azolla-anabaena* symbiosis. Pages 326-344 in Nitrogen and rice. International Rice Research Institute, P.O. Box 933, Manila, Philippines.
25. Pieterse, A.H., L. de Lange, and I.P. van Vliet. 1977. A comparative study of *Azolla* in the Netherlands. *Acta Bot. Neerl.* 26(6):433-449.
26. Postgate, J.R. 1982. The *Azolla* association. Pages 153-155 in The fundamentals of nitrogen fixation. Cambridge University Press.
27. Postgate, J.R. 1982. Physiology: assimilation of product. Pages 90-92 in The fundamentals of nitrogen fixation. Cambridge University Press.
28. Raab, L. 1980. Untersuchungen über den Proteinabbau und die Proteinsynthese im künstlichen Pansen. Dissertation Universität Hohenheim, FRG.
29. Rains, D.W., and S.N. Talley. 1978. Use of *Azolla* as a source of nitrogen for temperate zone rice culture. Pages 167-174 in Proc. Second Rev. Meeting I.N.P.U.T.S. project, East West Center Resource Systems Institute, Honolulu, Hawaii, USA.
30. Rains, D.W., and S.N. Talley. 1979. Uses of *Azolla* in North America. Pages 417-431 in Nitrogen and rice. International Rice Research Institute, P.O. Box 933, Manila, Philippines.
31. Roger, P.A., and P.A. Reynaud. 1979. Premieres donnees sur l'ecologie d' *Azolla africana* en zone sahelienne (Senegal). *Ecol. Plant.* 14(1):75-84.
32. Scharpenseel, H.W., K.H. Menke, D. Goetz, H. Meyer-Spasche, and K. Dorffling. 1982. Anzucht, Analyse und Nutzung des stickstoffsammelnden Systems *Azolla-anabaena* sp. *filiculoides* in Nährlosungen und Klarbrühen. *Landwirtsch. Forsch.* 35:200-213.
33. Shaumuyan, K.T. 1978. Control of biological nitrogen fixation. Pages 393-415 in Nitrogen in the environment. New York.
34. Smith, J.B. 1910. *Azolla* vs. mosquitoes. *Entomological News and Proc. Entomological Section, Acad. Nat. Sci., Philadelphia*, 21(10):437-441.
35. Talley, S.N., and D.W. Rains. 1980. *Azolla* as a nitrogen source for temperate rice. Pages 31 1-320 in Nitrogen fixation: proceedings of the Steenbock-Kettering Symposium, Madison, 1978. Vol. 2. University Park Press, Baltimore.
36. Talley, S.N., and D.W. Rains. 1980. *Azolla-filiculoides* Lam. as a fallow-season green manure for rice in a temperate climate. *Agron. J.* 72(1):11-18.
37. Talley, S.N., B.J. Talley, and D.W. Rains. 1977. Nitrogen fixation by *Azolla* in rice fields. Pages 259-281 in Genetic engineering for nitrogen fixation. Alexander Hollaender, ed. Plenum Press, New York.
38. Yatazawa, M., G. Mitarai, T. Takano, K. Nitta, and N. Tanatsugu. 1984. Biological functions to be used in CELLS. Pages 1653-1656 in Proceedings 14th international symposium on space technology and science. Tokyo.

Use of *Azolla* as a decontaminant in sewage treatment

N. SHIOMI AND S. KITO
Department of Applied Biology
Radiation Center of Osaka Prefecture
Sakai, Osaka, Japan

Two *Azolla* species were used to treat waste water. Because of *Azolla*'s N₂-fixing ability, the efficient removal of P from the waste water would be expected even after the N is consumed. The best growth, 2.5 d doubling time for *Azolla japonica*, and highest nutrient removal were achieved when the P level was higher than the N level. A significant removal of ammonium was observed during the first 3 d after transfer. The P absorption capacity of *Azolla* in the secondary treated effluent did not differ from that observed in a synthetic culture medium. Nutrient removal capacities of *Azolla* by batch culture were lower for N and higher for P than the values reported for other aquatic plants. Subsequent analyses of crude protein content and amino acid composition proved that *Azolla* plants may be a good biomass source of animal feed.

Eutrophication, the natural aging process that occurs in lakes and streams, has been accelerated by the excess of nutrient elements, particularly N and P forms discharged into streams from sewage treatment plants. Current research in pollution control has been directed toward removing these nutrients in treatment systems, thereby slowing the rate of eutrophication.

Nutrient removal processes, generally classified as tertiary treatment, consist basically of chemico-biological, chemico-physical, biochemical, and biological systems. These systems have been improved to the point that almost complete removal of nutrients is possible. However, the treatment cost is increasingly high.

Recently, various aquatic plants have been proposed to remove N and P. Among the plants used are *Eichhornia* (2), *Lemna* (4), *Spirodela* (10), *Nasturtium* (12), and *Ipomoea* (5). The average ratio of N to P in plants is 10: 1. Thus, a favorable uptake of N and P by aquatic plants will be observed in a culture solution containing N and P at a ratio of about 10:1 (14). Nutrient concentration, however, varies widely with waste water treatment plants. In most cases of waste water treatment by aquatic plants, P nutrient will remain after N removal.

We tried *Azolla* as a decontaminant of waste water because it grows by fixing atmospheric N_2 , and P removal can be expected even after the N is consumed.

On the other hand, *Azolla* plants have been used traditionally as a green manure in Vietnam (3) and China (7). *Azolla* cultured in waste water can be harvested for use as green manure for rice, further reducing waste water treatment cost. This could be an additional benefit of *Azolla* use in sewage treatment.

GROWTH IN THE SYNTHETIC NUTRIENT SOLUTION

Two species, *Azolla imbricata* and *A. japonica*, which are widely distributed in Japan, were used. Five g each of fresh *Azolla* were inoculated into trays ($21.7 \times 15.6 \times 8.4$ cm, surface area = 340 cm^2) containing 1 liter of medium and cultured in a growth cabinet. The pH of the medium was adjusted to 6.5 at which both species grew best (6).

The growth and the nutrient absorption patterns under different combinations of ammonium and P concentration are shown in Figure 1. The day/night temperature was 27/18 °C and the light intensity was 15 klx with 16 h photoperiods.

The growth patterns of the two species appeared similar. The best growth and the highest absorption capacity of nutrients were observed where the P concentration (31 ppm) was higher than that of ammonium (18 ppm) (Fig. 1d).

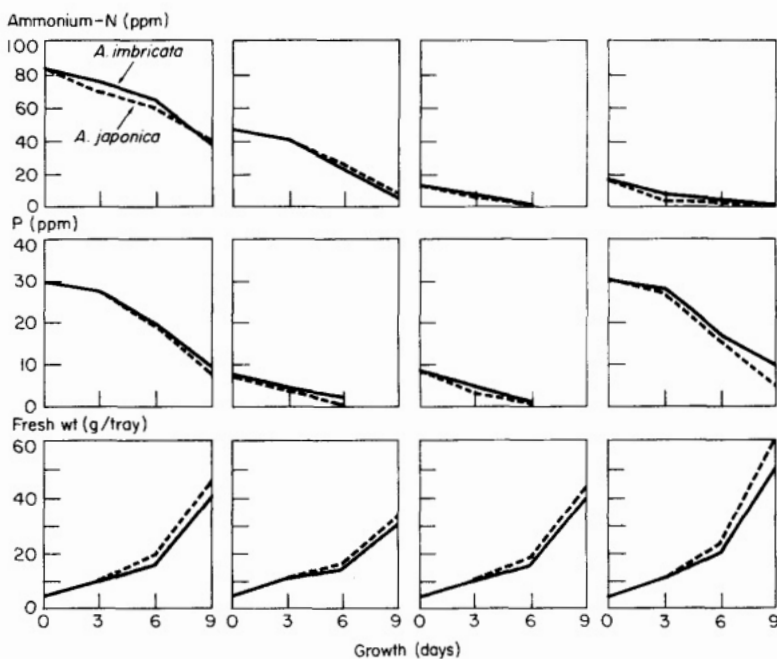

1. Growth of *Azolla* and decrease of N and P in the synthetic nutrient solution.

Both species absorb ammonium gradually through the nutrient solution. The absorption capacity at an optimum growth phase was estimated to be 2 mg N/tray per d at low N levels (Fig. 1c, d), and to be 5-6 mg N/tray per d at high N levels (Fig. 1a, b). *Azolla* can absorb P completely at low concentration levels (Fig. 1b, c) during 6 d of growth. About 30-40% of P in high concentrations remained after 9 d although the daily absorption of 1.5-2.0 mg P/tray per d was a little higher than that in low concentration level (Fig. 1a, d). These absorption patterns were all low compared with that of N-free medium.

The growth rate and the nutrient absorption patterns of *Azolla* grown at a comparatively low (15-22°C) and high (22-30°C) temperature were examined. At temperatures from 15 to 22°C, growth declined rapidly in *A. imbricata*, to about half that of *A. japonica*. No significant difference in ammonium absorption capacity at high concentration levels was found. In P absorption, a somewhat slower pattern was observed in *A. imbricata*. After 9 d of growth, about 60% of P was absorbed by *A. imbricata* and 80% was absorbed by *A. japonica*. In contrast, a higher growth rate and nutrient absorption capacity were found in *A. imbricata* than in *A. japonica* at 22-30 °C. The results were consistent with the different optimum temperature of each species (6).

GROWTH IN TREATED EFFLUENT

Secondary treated effluent of a domestic sewage treatment plant was sampled and used as nutrient after it was diluted with water. The temperature was 18-27 °C and other conditions, except the pH of the medium which was not adjusted, were the same as the preceding experiment. The initial pH of the medium (7.1-7.6) declined gradually to about 5.0 after the culture. This decline was not so large compared with that in the synthetic nutrient solution. In an initial medium containing more than 200 ppm ammonium, the growth of *Azolla*, especially *A. imbricata*, was extremely poor and red pigmentation appeared in the fronds within a few days of transfer.

The growth patterns and the removal of nutrients in the secondary treated effluent are shown in Figure 2. Ammonium concentration in the effluent decreased as A>B>C. The best growth and the highest removal of nutrients were obtained when the P level was higher than the N level (Fig. 2c) as in Figure 1. In the case of c (NH₄-N = 10 ppm, P = 13.5 ppm), the growth progressed geometrically, and the doubling time of 2.5 d in *A. japonica* was the same as in the N-free medium. The growing pattern at high levels of N and P (Fig. 2a) was also close to that of the synthetic solution. Nutrient removal from the treated effluent was favorable and a high ammonium uptake was observed during the first 3 d after transfer. Ammonia may evolve from alkaline waters with pH 7.5 or higher that contain ammonium. We confirmed that about 20-30% ammonium in the waste water was volatilized during the first 3 d. The net average absorption capacity was estimated to be 5.5-7.0 mg N/tray per d. P was completely removed within 6 d. The absorption rate was 2-3 mg P/tray per d, similar to that of N-free medium.

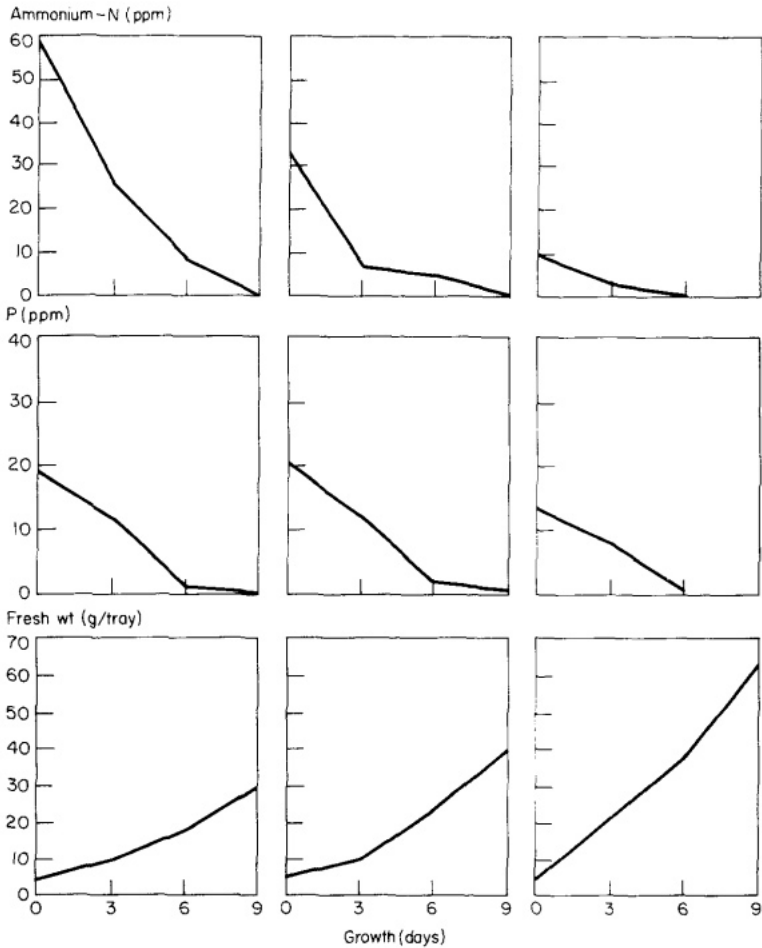

2. Growth of *Azolla japonica* and decrease of N and P in secondary treated effluent.

Comparisons of the growth and nutrient removal were made among *Azolla* inocula of 5, 15, 20 g per tray. The samples corresponded to 25, 50, 100%, coverage of the surface of nutrient solution. The sample fully covered with *Azolla* had the highest harvest and nutrient removal (Fig. 3c), but the removal patterns did not parallel the amount of initial inoculum. This implies the existence of an optimum density of *Azolla* inocula for the most effective nutrient removal.

Matsumoto (10) examined the absorption capacities of various aquatic plants and compared them in batch culture with the total surface area covered with plants. We compared the absorption capacity of several plants including *Azolla* covering the total water surface, in a manner similar to Matsumoto (Table 1). This experiment was done outdoors using big trays 70 x 100 x 12 cm containing 30 liters of the secondary effluent. The absorption capacity

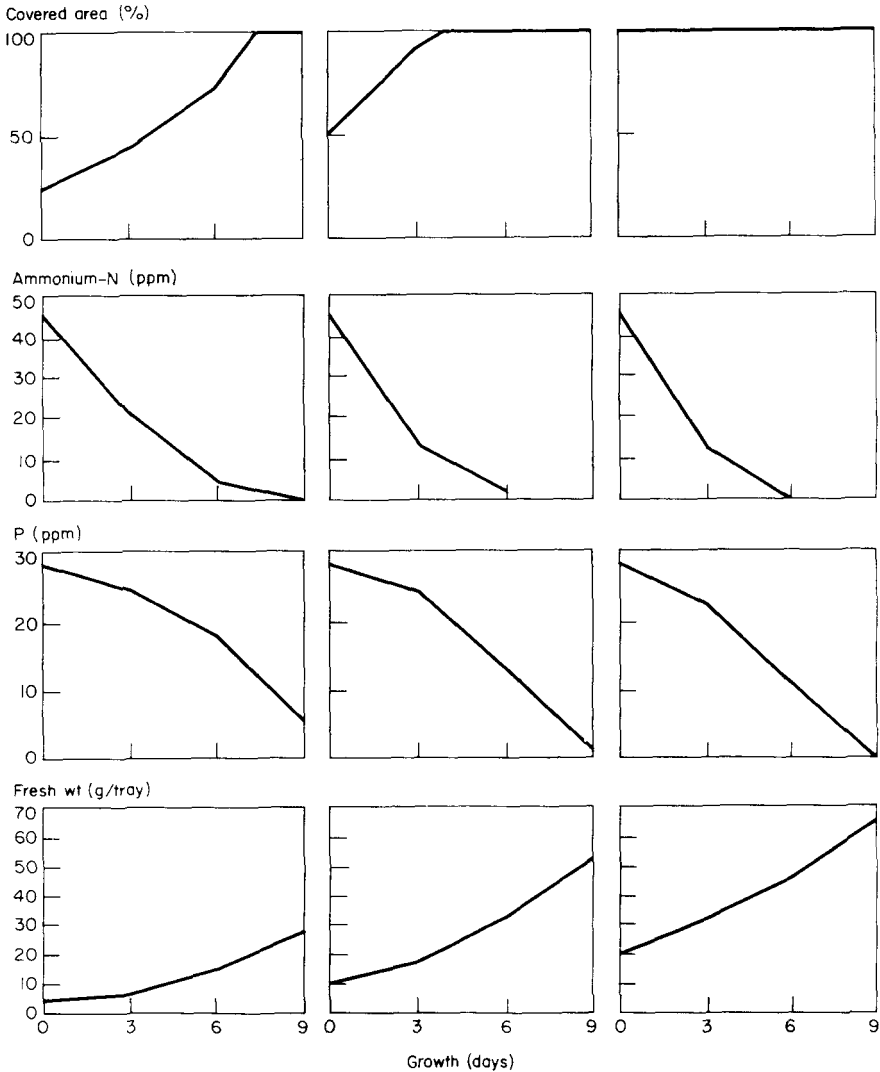

3. Growth of *Azolla imbricata* and decrease of K and P in secondary treated effluent inoculated differently.

Table 1. Absorption capacity of N and P by some aquatic plants.

Plant	Absorption capacity (mg/m ² per d)	
	N	P
<i>Spirodela polyrhiza</i> ^a	260-278	40-65
<i>Lemna paucicostata</i> ^a	245-268	38-58
<i>Eichhornia crassipes</i> ^a	265-280	50-72
<i>Azolla japonica</i>	155-250	60-75

^aBy Matsumoto (10).

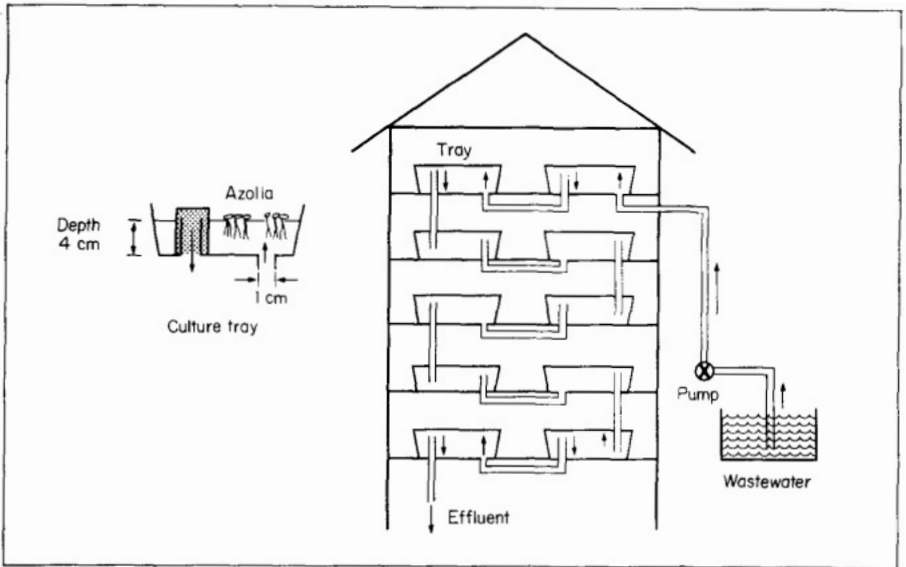

4. Apparatus for culturing *Azolla* in continuously flowing water.

of *Azolla* for P was higher than for N. N absorption capacity, however, varied widely depending on culture conditions.

An apparatus was devised to culture *Azolla* in continuously flowing waste water (Fig. 4). The apparatus consists of a series of 4.6 liter-capacity trays. Waste water is pumped to the top tray and then flows by gravity to the bottom tray where the effluent is sampled. At a flow rate of 15.5 ml/min, about 65% N and 25% P were removed. Removal rate, however, especially that for P, declined with increasing flow rate. Only 7% of P was removed at 62.2 ml/min.

CRUDE PROTEIN AND AMINO ACID CONTENTS

The harvested *Azolla* plants cultured in waste water will be used as green manure (8), animal feed, and bio-fuels. There are a number of reports on the use of *Azolla* as animal feed (11), and as fish feed (1). In view of these considerations, a dried sample of *Azolla* was hydrolyzed (13) to compare its crude protein and amino acid content to those of various other plants. The *Azolla* plants cultured in the secondary treated effluent had a little higher crude protein (av 30 g/100 g dry wt). *Azolla* plants were comparatively high in crude protein compared to other plants (Table 2), suggesting that *Azolla* can be a good animal feed. Although methionine and histidine content in 10 essential amino acids were less than for other plants tested, total amino acids were high.

Makino (9) has suggested treating waste water by the simultaneous use of aquatic plants and fish. A search was made for aquatic plants with four characteristics: 1) rapid growth, 2) high nutrient absorption capacity, 3) ease of handling, and 4) potential for economic use. We propose a model for waste

Table 2. Amino acid composition in *Azolla* and some other plants.

Amino acid	Amino acid content (g/100 g dry wt)			
	<i>Azolla</i> ^a	<i>Ipomoea</i> ^b	<i>Lemna</i> ^c	<i>Spinach</i> ^b
Aspartate	2.05	3.81		3.1
Threonine	2.35	1.61	1.06	1.1
Serine	1.96	1.41		1.0
Glutamate	4.54	4.05		5.0
Proline	0.60	1.84		1.1
Glycine	1.60	1.89		1.3
Alanine	1.42	2.19		1.4
Valine	1.10	2.32	1.80	1.3
Methionine	0.22	0.67	0.32	0.2
Isoleucine	0.80	1.79	1.73	0.9
Leucine	1.51	3.04	2.00	1.9
Tyrosine	0.65	1.31		1.0
Phenylalanine	1.32	2.04	0.91	1.3
Lysine	1.24	0.48	1.92	1.6
Histidine	0.24	0.88	0.36	0.6
Arginine	1.66	2.08	1.17	1.6
Total	23.26	31.41		24.4

^a *A. japonica* cultured in a secondary treated effluent. ^b By Hashimoto (5). ^c By Matsumoto (10). Only essential amino acids were compared.

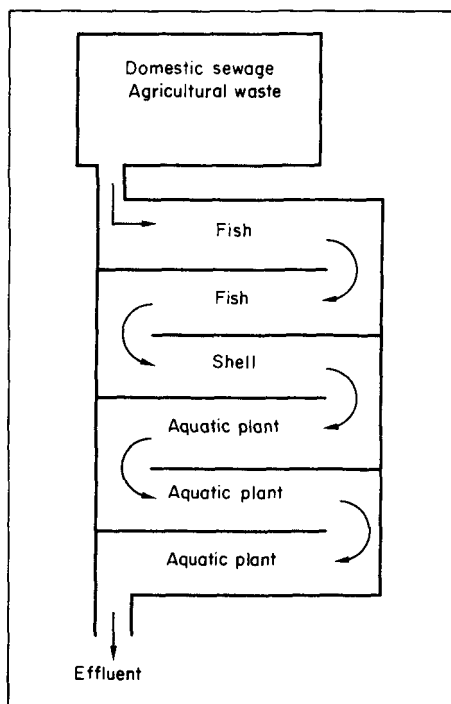

5. Model of waste water treatment by using aquatic plants and fish.

water treatment with *Azolla* and fish such as *Lebistes*, *Carassium*, *Cyprinus*, and *Tilapia* (Fig. 5). Two or three aquatic plants are promising candidates. *Azolla* and *Eichhornia* are prolific and, being free-floating, would be easier to harvest than a rooted aquatic.

The use of subtropical *Eichhornia* and temperate *Azolla* and *Nasturtium*, which are cold tolerant, is recommended. Further studies are needed to determine whether these procedures are of any practical value.

REFERENCES CITED

1. Biswas, K. 1943. Balanced vegetation and pisciculture. *Sci. Cult.* 9:142-146.
2. Cornwell, D.A., J. Zoltek, Jr., and C.D. Patrinely. 1977. Nutrient removal by water hyacinths. *J. Water Pollut. Control Fed.* 49:57-65.
3. Dao, T.T., and Q.T. Tran. 1979. The use of *Azolla* in rice production in Vietnam. Pages 395-405 in *Nitrogen and rice*. International Rice Research Institute, P.O. Box 933, Manila, Philippines.
4. Harvey, R.M., and J.L. Fox. 1973. Nutrient removal using *Lemna* minor. *J. Water Pollut. Control Fed.* 45:1928-1938.
5. Hashimoto, S. 1983. Wastewater treatment by channel flow system and food production [in Japanese]. *Water Purification and Liquid Wastes Treatment* 24:17-24.
6. Kitoh, S., and N. Shiomi. 1984. Nutrient removal by *Azolla* from the mineral nutrient solution and wastewater [in Japanese]. *Water Purification and Liquid Wastes Treatment* 25:19-25.
7. Liu, C. 1979. The use of *Azolla* in rice production in China. Pages 375-394 in *Nitrogen and rice*. International Rice Research Institute, P.O. Box 933, Manila, Philippines.
8. Lumpkin, T.A., and D.A. Plucknett. 1980. Botany, physiology and use as a green manure. *Econ. Bot.* 34:111-153.
9. Makino, S. 1976. Wastewater treatment by the use of biological systems [in Japanese]. *Water and Waste* 18:15-19.
10. Matsumoto, S. 1981. Nutrient removal by *Spirodela polyrhiza* and its use [in Japanese]. *Chem. Biol.* 19594-600.
11. Moore, A.W. 1969. *Azolla* biology and agronomic significance. *Bot. Rev.* 35:17-34.
12. Sakurai, Y., Y. Watanabe, and N. Nakamoto. 1978. Domestic sewage treatment in rural districts [in Japanese]. Abstracts of the 1978 Meeting, Japanese Soc. Biol. *Liquid Wastes Treatment* 11-14:5.
13. Shiomi, N., and S. Hori. 1973. Proline-¹⁴C metabolism in barley seedlings during vernalization. *Plant Cell Physiol.* 14:1009-1018.
14. Steward, K.K. 1970. Nutrient removal potentials of various aquatic plants. *Hyacinth Control J.* 81:34-35.

DISCUSSION

KANNAIYAN: Could you tell us the amount of heavy-metal absorption by *Azolla*, *Eichhornia*, or *Lemna*?

SHIOMI: I did not determine heavy-metal absorption by *Azolla* because *Azolla* biomass is limited to the treatment of domestic waste. I don't think that *Azolla* absorbs many metal ions. I have heard that *Eichhornia* does, so it would not be good for animal feed. I don't know about *Lemna*, but I think it is more like *Azolla*.

XIE YING-XIAN: Can you give me some information about *Spirulina platensis* in Japan?

SHIOMI: I am not familiar with *Spirulina*. Many blue-green algae grow in Japan. However, salt concentration in Japanese lakes is not high. I do not think that *Spirulina* can survive in them. If you could cultivate *Spirulina* in Chinese lakes or ponds, it would be a good biomass.

LUMPKIN: Are agricultural wastes and domestic sewage safe for introducing into human food chain in Japan?

SHIOMI: In Japan those liquid wastes are discharged into rivers after primary and secondary treatment, principally by the activated sludge method. At present I do not think it is safe. Domestic waste, unlike industrial waste, has few heavy-metal ions, so *Azolla* plants cultured in secondary liquid waste would be a good animal feed.

Use of *Azolla* in Pakistan

S. ALI AND K.A. MALIK

Nuclear Institute for Agriculture and Biology

Jhang Road, P.O. Box 128

Faisalabad, Pakistan

Azolla has been used traditionally as green manure for rice production in Southeast Asia (2, 3, 10). *Azolla-Anabaena* symbiosis can fix N comparable to legumes and much more than free-living bacteria and blue-green algae (8). *Azolla* significantly increases rice yields and improves soil properties (4,5,6). Studies on *Azolla* in Pakistan cover its natural distribution, ecology, cultivation, pest control; N₂ fixation, mineralization, and effect on rice yield.

Central Punjab was surveyed to study *Azolla* natural distribution and ecology. *Azolla pinnata* grows in stagnant or slow moving water at 11 places in the upper central Punjab; mostly in ditches and drains. It was found in only two ricefields, one of which was fallow. *Lemna minor*, *Hydrilla verticillata*, *Typha angustata*, *Ipomoea aquatica*, *Eichhornia* sp., *Leptochloa fusca*, and other grasses grow in the same habitat. Floodwater pH in these habitats ranged from 7.9 to 8.9 and electrical conductivity (EC_e) from 0.3 to 1.75 dS/m; however, *Azolla* grew well in pH up to 8.5 and EC_e below 1.3. Na:Ca (<10) promoted *Azolla* growth.

Azolla plants were abundant only in the cold months (Nov-Apr). *A. pinnata* growing naturally is, therefore, sensitive to high temperature, which prevails during rice season, making its use difficult. By growing native *Azolla* in cold water containing farmyard manure (FYM) and shading it from strong sunlight during hot days for about 3 yr, a heat-tolerant strain that can grow at temperatures prevailing in the Punjab was selected.

AZOLLA CULTURE MEDIA

To maintain the local *Azolla* strain under conditions resembling its natural habitat, four culture media (reconstituted according to the floodwater analysis in which *Azolla* growth was better) were tried (Table 1). Plastic tubs (30 cm diam, 15 cm deep) three-fourths filled with culture media were used for *Azolla* culture. Growth and N₂ fixation of *Azolla* were compared to growth and N₂ fixation in IRRI *Azolla* medium (1 1). More *Azolla* biomass and chlorophyll were harvested in IRRI *Azolla* medium adjusted to pH 6.5 than in the other media with pH 8.0. However, when pH of all these was adjusted to 8.0, the

Table 1. Ingredients of different culture media for *Azolla*.^a

Ingredients	Az. M.	BT	MD	KB	KA
<i>Macronutrient (g/liter)</i>					
CaCl ₂	0.333	0.139	0.036	0.019	0.019
MgCl ₂ ·6H ₂ O	—	—	0.085	0.056	0.058
MgSO ₄ ·6H ₂ O	0.492	1.185	0.141	0.076	0.111
NaHCO ₃	—	0.252	0.365	0.168	0.252
KCl	—	0.073	—	0.008	0.008
K ₂ SO ₄	0.274	—	—	—	—
Na ₂ SO ₄	—	0.541	—	—	—
K ₂ CO ₃	—	—	0.014	—	—
NaCl	—	0.148	—	—	—
MgCO ₃	—	—	0.036	—	—
KH ₂ PO ₄	—	0.005	0.005	0.005	0.005
NaH ₂ PO ₄	0.12	—	—	—	—
<i>Micronutrient (mg/liter)</i>					
Fe	0.2	0.16	0.09	0.63	0.09
Mn	0.1	0.03	0.03	0.06	0.03
Zn	0.012	0.02	0.02	0.02	0.02
Cu	0.005	0.003	0.01	0.01	—
Co	—	0.1	0.1	0.1	0.1
Mo	0.005	0.01	0.01	0.01	0.01
B	0.635	0.1	0.1	0.1	0.1

^aAz. M. = IIRI *Azolla* medium; BT = Black tub floodwater; MD = Maridkey Drain floodwater; KB = Khori floodwater, site B; KA = Khori floodwater, site A.

common pH of floodwater of ricefields in Punjab, Khori floodwater site B (KB) medium was best (Fig. 1). Similarly, N₂ fixation was highest for IIRI medium at pH 6.5, and for KB medium when pH of all the other media was set at 8.0 (Table 2).

So farmers could maintain *Azolla* culture, simple and less defined culture media were tried. Glazed pots 25 cm in diam containing 13 liters canal water were used for nursery maintenance. The water was amended with 2.0 mg Fe/liter, 10 mg P/liter, IIRI *Azolla* medium, trace elements as in IIRI *Azolla* medium, and 10 g air dried FYM/liter. Pots were inoculated with 3 g fresh *Azolla*/ pot in the first week of April, and *Azolla* was harvested at 2-wk intervals; each pot was reinoculated with 3 g *Azolla*. By the last week of September, total fresh *Azolla* biomass harvested per pot (av of 3 replications) was 77 g for control (canal water), 113 g for Fe, 123 g for trace elements, 139 g for FYM + P, 164 g for FYM, 166 g for IIRI *Azolla* medium, 178 g for P, 205 g for Fe + P + FYM, 209 g for Fe + P, and 270 g for Fe + FYM. The study indicated that a small quantity of FYM or P added to canal water promoted better *Azolla* nursery maintenance on a small scale, and adding FeCl₃ may further increase *Azolla* yield.

Azolla growth was compared in defined and less defined culture media. Plastic tubs (30 cm diam) three-fourths filled with culture solution were used. As little as 0.5% FYM, even at pH 8-9, gave maximum yield with minimum doubling time (Table 3). Because humic acids are one of the main components of FYM, the effect of adding humic acid to the nutrient culture media on

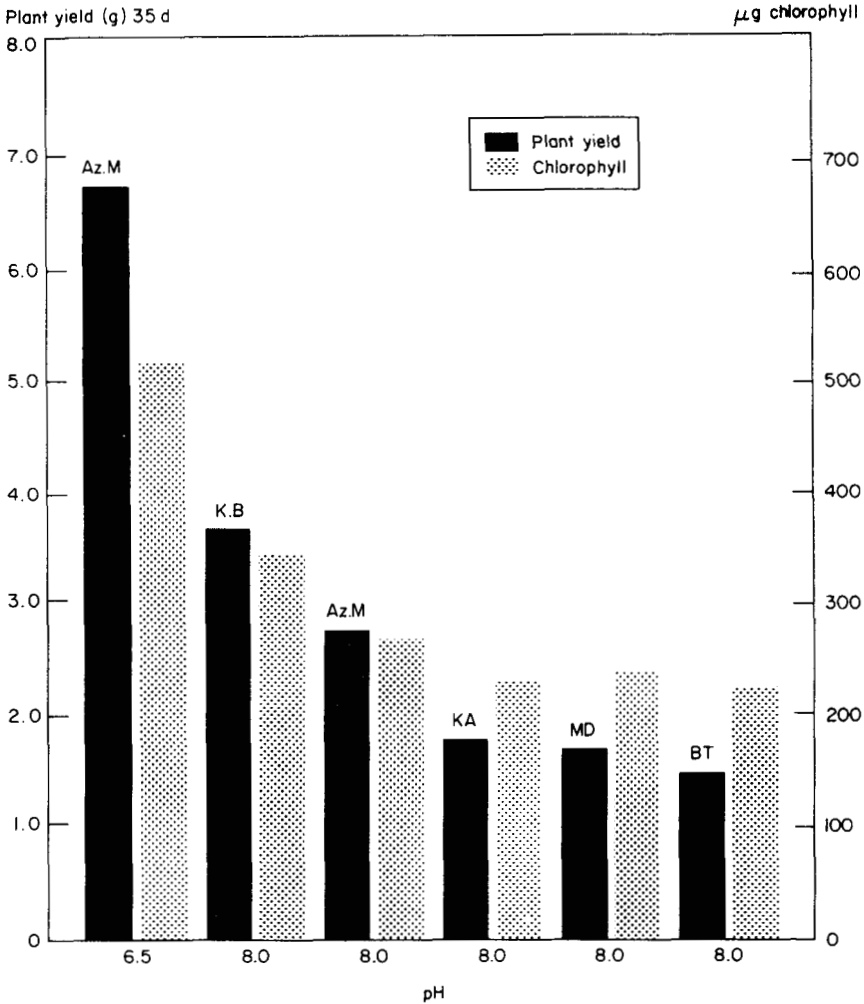

1. Yield of *Azolla* grown on different media of different pH.

Table 2. Nitrogenase activity of *Azolla* grown in different nutrient media.

Medium	pH	2 h	3 h	23 h
Az. M.	6.5	21.12	38.34	126.96
	8.0	4.58	6.72	37.96
KA	8.0	9.3	12.11	49.9
KB	8.0	4.002	7.0	27.65
BT	8.0	4.79	6.22	27.65
MD	8.0	7.03	—	42.16

Azolla growth and N_2 fixation was studied. Glass beakers containing 400 ml nutrient media were used for *Azolla* cultivation and 30-mm-diam glass tubes were used for acetylene reduction assay (ARA). The glass tubes were inverted

Table 3. Comparison of *Azolla* growth on defined and undefined medium.

Media	pH	Inoculum (g)	Yield after 4 mo g	Doubling time (d)
KB	8.0	10	470	5.1
Az. M.	6.5	10	565	4.2
Soil + FYM ^a	8.0	10	594	4.0
FYM ^a	8.0-9.0	10	600	3.6

^a FYM = farmyard manure.

Table 4. Comparison of *Azolla pinnata* growth and nitrogenase activity on KB medium in presence of humic acid (HA), NH₄-N, and farmyard manure (FYM).

Treatment	Yield after 24 d (g)	Biomass increase over inoculum	Doubling time (d)	Nitrogenase activity (nmol C ₂ H ₄ /g fresh wt per h)
Control (KB medium)	6.2	12.4	3.9	460
KB + 0.0175% HA	7.4	14.7	3.3	460
+ 0.035% HA	9.6	19.3	2.5	760
+ 0.052% HA	10.5	20.9	2.3	1020
KB + 14 ppm N	8.9	17.9	2.7	760
+ 28 ppm N	6.4	12.7	3.8	740
+ 42 ppm N	6.7	13.4	3.6	920
FYM 0.5%	10.4	20.8	2.3	710
FYM 0.5% + 5% soil	13.4	26.8	1.8	1420

in the beakers containing *Azolla* and the upper end was stoppered with a Suba seal for 10% C₂H₂ injection. After 2, 3, and 23 h incubation, gas samples were taken in 5-ml Vacutainer tubes and analyzed by gas chromatography for C₂H₄ assay. The effect of mineral N as ammonium sulfate was also observed. Results indicated that maximum growth and N₂ fixation occurred in 0.5% FYM + 5.0% soil added to distilled water (Table 4). The next best and comparable growth was observed in KB medium + 0.05% humic acid and 0.5% FYM, but nitrogenase activity was lower in the latter. Adding 14 ppm mineral N as (NH₄)₂SO₄ improved growth and nitrogenase activity, indicating the possibility of using *Azolla* with chemical N fertilizer at low concentrations.

The continuation of N₂ fixation by *Azolla* in the presence of mineral N in the culture medium has been reported by other workers (1, 7, 9, 12).

PEST CONTROL

Water snails *Lymnaea* sp. fed on *Azolla* during greenhouse cultivation. We used 4 insecticides in culture solution at 2.5, 3, 5, 10, and 30 ppm a.i. to control snails. The minimum concentration required to kill the snails in 24 h was 5 ppm chlorobenzilate and 30 ppm heptachlor, monocrotophos, and carbofuran. Minimum concentrations of all insecticides inhibited *Azolla* growth. Carbofuran was the least toxic to *Azolla* (Table 5), and effectively controlled water snails of family Planorbidae, small bivalve crustaceans Ostracoda, and *Nymphulus* sp. larvae.

Table 5. Effect of minimum concentrations of different insecticides required for killing snails, on *A. pinnata* in 1-liter plastic beakers containing 400 g soil and 400 ml canal water.

Insecticide	Concentration in flood water (ppm a.i.)	<i>Azolla</i> biomass production	
		g/beaker ^a (fresh wt)	% of control
Control	-	5.5	100
Akar	5	0.8	15
Heptachlor	30	3.2	58
Nuvacron	30	4.0	73
Furadan	30	5.0	91

^aAv of 3 replications.

AZOLLA DECOMPOSITION

¹⁴C and ¹⁵N labeling of *Azolla*

A. pinnata was grown in a growth room with a $30 \pm 5^\circ\text{C}$ temperature, 90% relative humidity (RH), and 9 klx light for 16 h a day. Pulse labeling of *Azolla* for 3 h was done twice at 2-d intervals in a 6-liter flask with 1 liter KB medium containing 0.05% humic acid and 5% ($^{15}\text{NH}_4$) $_2\text{SO}_4$. $^{14}\text{CO}_2$ was generated inside the flask by adding dilute lactic acid to Na_2 ($^{14}\text{CO}_3$) contained in a small beaker hung from the flask stopper. $^{14}\text{CO}_2$ was mixed inside the flask by pumping in and out with a two-way cadet pump. After 1 wk of incubation, the *Azolla* plants were harvested. A small amount was used to estimate its radioactivity by combusting it in a Packard Sample Oxidizer and measuring the activity in a Tricarb 3320 liquid scintillation counter. ^{15}N abundance was estimated with a Mat GD 150 mass spectrometer.

Azolla mineralization

The double-labeled *Azolla* was added to soil for mineralization studies. The N mineralization pattern is given in Figure 2. $\text{NO}_3\text{-N}$ reached peaked after 1 wk and rate remained almost constant during the next 2 wk in upland soil. Similarly, $\text{NH}_4\text{-N}$ formation peaked by the first week, but decreased during the next 2 wk in lowland soil. The rapid nitrification which led to formation of more $\text{NO}_3\text{-N}$ in upland soil probably resulted from less reduced conditions. The reverse was true for lowland soil. However, overall mineralization was more in upland than in lowland soils — in 7 d, about 50% *Azolla* N was mineralized in upland soil compared to 31% in lowland soil.

The rate of C release from *Azolla* was higher in upland than in lowland soil (Fig. 3). After 40 d, about 35% CO_2 was evolved from upland soil and 22% from lowland soil amended with *Azolla*, nearly half of the CO_2 evolved in the first 10 d of incubation.

Evolution of labeled C in CO_2 also showed higher decomposition rate in upland soil than in lowland soil (Fig. 4). The release of $^{14}\text{CO}_2$ reached maximum by the 10th day and about 68% $^{14}\text{CO}_2$ was evolved within the first 10 d of incubation.

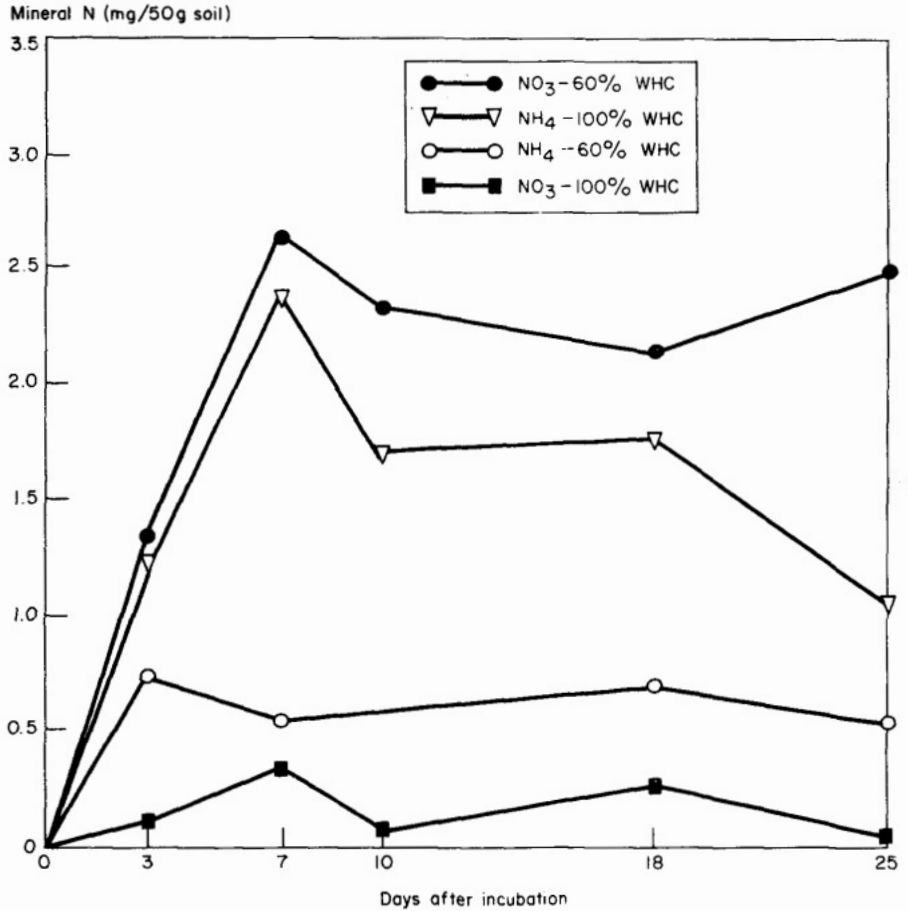

2. N mineralization in soil amended with *Azolla*.

CONTRIBUTION OF AZOLLA TO STABLE ORGANIC MATTER

During *Azolla* decomposition in soil, immobilization of NH₄ and NO₃-N took place along with mineralization. The C and N content estimated in humic and fulvic acid at the end of incubation are given in Table 6. More of these two organic acids were formed in soil amended with *Azolla* than in control, and more humic acids were formed in upland soil than in lowland soil. This indicates that *Azolla* increases the stable organic matter in soil.

EFFECT OF AZOLLA ON RICE YIELD

A pot study was conducted to determine the effect of *Azolla* on Basmati-370. The increases in grain yields were 37% for *Azolla* incorporation, 33% for *Azolla* + *Azolla* medium, 36% for *Azolla* + *Azolla* medium + 0.1% FYM, 2%

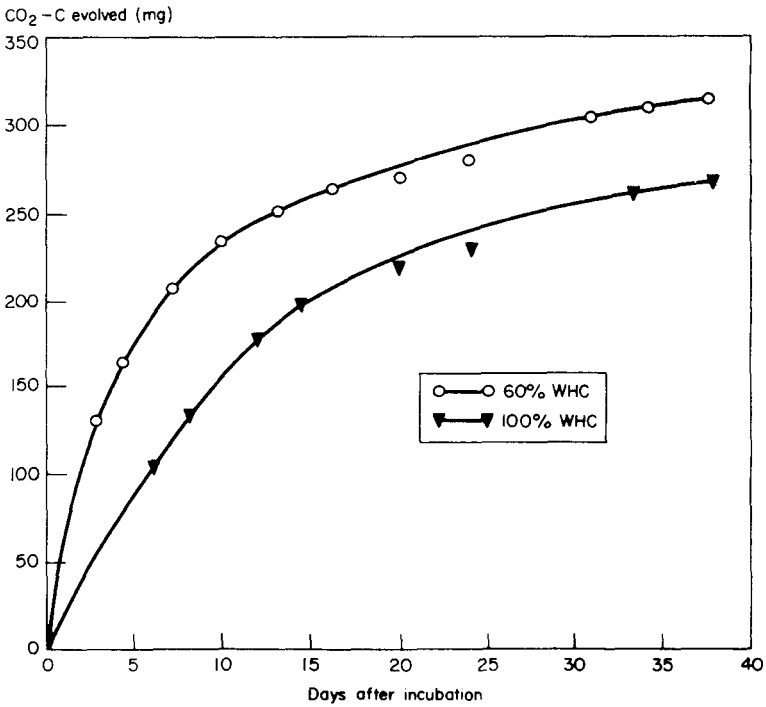

3. Mineralization of soil-incorporated *Azolla*.

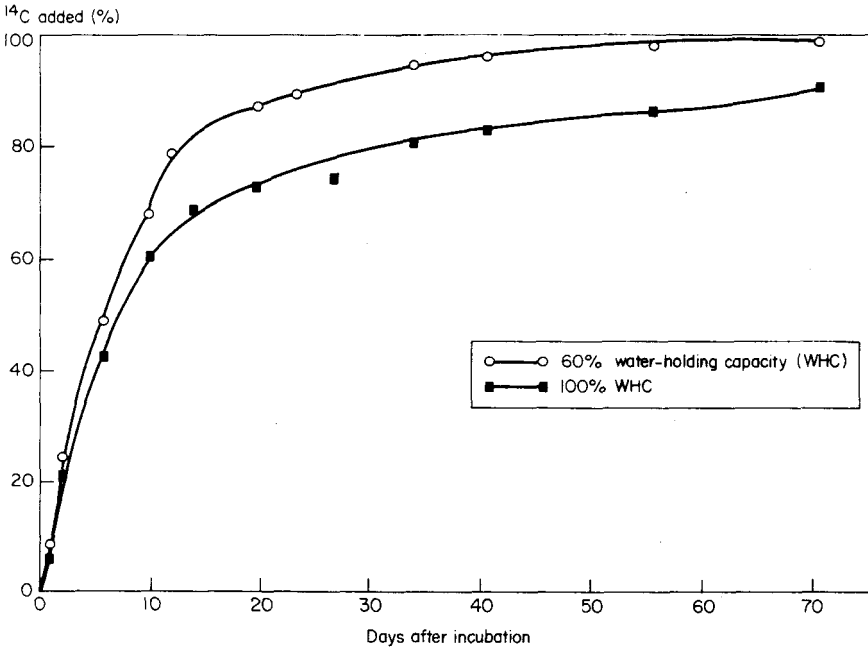

4. Evolution of ¹⁴CO₂ from soil after decomposition of uniformly labeled *Azolla* sp.

Table 6. Determination of fluvic and humic acids in soil at two water-holding capacities with and without *A. pinnata*.

Water-holding capacity (%)	Acid	Without <i>A.pinnata</i>	With <i>A. pinnata</i>
<i>C content (µg/g soil dry wt)</i>			
60	Humic	330	700
60	Fluvic	460	620
100	Humic	330	550
100	Fluvic	40	560
<i>N content (µg/g soil dry wt)</i>			
60	Humic	83	97
60	Fluvic	43	78
100	Humic	52	73
100	Fluvic	89	48

Table 7. Effect of *Azolla* inoculation on rice yield.

Treatment	Straw		Grain		Straw + grain	
	g/pot	Increase (%)	g/pot	Increase (%)	g/pot	Increase (%)
Control	10.18	—	9.29	—	19.47	—
<i>Azolla</i>	11.33	11	12.72	37	24.05	23
<i>Azolla</i> + Az. M.	11.15	10	12.40	33	23.55	21
<i>Azolla</i> + Az. M. + FYM ^a	12.34	21	12.65	36	24.99	28
Dead <i>Azolla</i>	10.38	2	9.52	2	19.90	2
40 kg N/ha	13.52	33	14.02	51	27.54	41
60 kg N/ha	16.34	61	16.92	82	33.26	71

^aFYM = farmyard manure.

for dead *Azolla* (equal to live inoculum), 50% for urea at 40 kg N/ha, and 82% for urea at 60 kg N/ha. The benefit of *Azolla* to the rice crop was equivalent to the addition of 40 kg N/ha (Table 7).

REFERENCES CITED

1. Becking, J. H. 1976. Contribution of plant-algae associations. Pages 556-580 in First international symposium on nitrogen fixation. Vol. 2. W. E. Newton and C. J. Nyman, eds. Washington State University, Pullman.
2. Havelka, D. V., M. G. Boyle, and R. W. F. Hardy. 1982. Biological nitrogen fixation. Pages 365-422 in Nitrogen in agricultural soils. Agron. Ser. 22. F. J. Stevenson, ed. American Society of Agronomy, Madison, Wisconsin.
3. Liu, C. C. 1979. Use of *Azolla* in rice production in China. Pages 375-394 in Nitrogen and rice. International Rice Research Institute, P. O. Box 933. Manila, Philippines.
4. Lumpkin, T. A., and D. L. Plucknett. 1980. *Azolla*: botany, physiology, and use as a green manure. Econ. Bot. 34:111-153.
5. Lumpkin, T. A., and D. L. Plucknett. 1982. *Azolla* as a green manure: use of management in crop production. Westview Press, Boulder, Colorado.
6. Moore, A. W. 1969. *Azolla*: biology and agronomic significance. Bot. Rev. 35:17-35.

5. Peters, G. A., O. Ito, V. V. S. Tyagi, B. S. Myne, D. Kaplan, and H. E. Calvert. 1981. Photosynthesis and N₂ fixation in the *Azolla-Anabaena* symbiosis. Pages 121-124 in Current perspective in nitrogen fixation. A. H. Gibson and W. E. Newton, eds. Australian Academy of Science, Canberra.
8. Stevenson, F. J. 1982. Origin and distribution of nitrogen in soil. Pages 1-66 in Nitrogen in agricultural soils. Agron. Ser. 22. F. J. Stevenson, ed. American Society of Agronomy, Madison, Wisconsin.
9. Talley, S. N., B. J. Talky, and W. D. Rains. 1957. Nitrogen fixation by *Azolla* in ricefields. Pages 259-281 in Genetic engineering for nitrogen fixation. A. H. Hollaender, ed. Plenum Press, New York.
10. Tuan, D. T., and T. Q. Thuyet. 1979. Use of *Azolla* in rice production in Vietnam. Pages 395-405 in Nitrogen and rice. International Rice Research Institute, P. O. Box 933, Manila, Philippines.
11. Watanabe, I., C.R. Espinas, N.S. Berja, and B.V. Alimagno. 1977. Utilization of the *Azolla-Anabaena* complex as a nitrogen fertilizer for rice. IRRI Res. Pap. Ser. 11. 15 p.
12. Watanabe, I., Bai Ke-zhi, N.S. Berja, C.R. Espinas, O. Ito, and B.P.R. Subudhi. 1981. The *Azolla-Anabaena* complex and its use in rice culture. IRRI Res. Pap. Ser. 69. 11 p.

DISCUSSION

ESKEW: Was your temperature-tolerant strain a local selection or imported from outside Pakistan?

ALI: It was a local selection from Pakistan.

KANNAIYAN: How do you use farmyard manure for growing *Azolla*? Is it used as solution or mixed with soil?

ALI: Farmyard manure was used as such and was added to water culture (without soil). Farmyard manure was added into pots containing only canal water (no soil).

SWATDEE: Fresh *Azolla* increased paddy yield better than dead *Azolla*. Why?

ALI: Because dead *Azolla* cannot multiply and it was added once to the inoculum, whereas live *Azolla* inoculum multiplied and was incorporated at different times during rice growth.

**AGRONOMICAL ASPECT
OF *AZOLLA* USE**

Some aspects of rice-*Azolla* association in northern China

YOU CHONGBIAO, ZHANG RONGJU, AND SONG WEI

Institute for Application of Atomic Energy

Chinese Academy of Agricultural Sciences

P.O. Box 5109, Beijing, China

The sporophytic cycle of *Azolla filiculoides* Lam. has been studied to produce an inoculum that is easier to handle and store in northern China. *A. filiculoides* requires 25-30 d at a temperature of 18-25°C and a light intensity of 1-1.5 klx for sporophytic determination. Biological N fixation of *A. filiculoides* in the field was determined by ¹⁵N dilution using *Lemna polyrhiza* as reference plants. About 40-60% of *Azolla* N is fixed from atmospheric N₂ with about 5 kg N/ha being fixed within several days. The availability of *Azolla* N to rice was estimated by incorporating ¹⁵N-labeled *Azolla* 2 wk before transplanting and unlabeled *Azolla* at panicle initiation. From transplanting to panicle initiation, rice plants derived 35-58% of their N from *Azolla* N. The dynamics of ¹⁵N abundance in soil, nitrate reductase activity, and chlorophyll content of rice plants are also discussed.

Azolla traditionally has been used as green manure for rice in China. The biological nitrogen fixation (BNF) carried out by *Azolla* is of major benefit to rice farmers in north China. The use of *Azolla* has expanded gradually. Today the rice sown acreage totals 2.33 million ha in the north, compared to 1.46 million ha in 1974. Recent energy and nitrogenous fertilizer costs have stimulated interest in *Azolla*.

In this paper we have focused our attention on the N₂-fixing rate and N₂ cycling of *Azolla* in relation to rice by using the ¹⁵N dilution technique.

MATERIALS AND METHODS

Materials. *Azolla filiculoides* Lam. was used for inoculation or incorporation in field and pot experiments, using *Lemna polyrhiza* L. as reference plants.

The rice strain Yuefu, of medium duration (120 d), was selected. Seedlings were transplanted about 3 wk after germination at a plant spacing of 20 cm.

Field plots. A rice field with typical paddy soils near our institute was chosen. The characteristics of a composite soil sample (pH 7.2) for 0-15 cm depth are shown in Table 1.

Table 1. Some characteristics of paddy soil in Beijing. ^a

Characteristics	Content (% soil dry wt)
Total N	0.046
NH ₄ ⁺ -N	0.0063
NO ₃ ⁻ -N	0.002
P	0.22
K	1.55
Organic matter	2.25
Fe	0.006
Mg	0.946
Zn	0.008
Mn	0.051
Cu	0.0027
Ca	2.10
Na	1.54

^aSampling date: 26 Apr, before using *Azolla* in paddy fields.

The plots for estimating BNF of *Azolla* were 1 m² and separated from each other with a painted steel sheet. The plots were arranged in a randomized complete block design with three replications.

The plots for measuring the efficiency of utilization of *Azolla* N and urea N were 0.5 × 0.5 m with 4 replications.

Azolla and urea were incorporated to a depth of 5 cm on the bottom of a furrow between the rows of rice plants.

Pot experiments. The utilization of *Azolla* N and urea N was studied in 50-cm-diam plastic pots containing 25 kg paddy soil.

Growth of ¹⁵N-labeled Azolla. *A. filiculoides* was grown in an 80 × 60 cm plastic pool filled with paddy soil suspension containing 55 ppm concentration of (¹⁵NH₄)₂SO₄ or CO(¹⁵NH₂)₂ (10% abundance) for 2 wk before inoculating or incorporating into the ricefield or pots.

Assay methods. Total N was determined by Kjeldahl method and abundance of ¹⁵N with a mass spectrometer (6). The leaves were assayed for nitrate reductase activity (NIR) by the method of Garrett (2) and for chlorophyll content by the method of Arnon (1).

Scanning electron microscopy (SEM) photographs of sporocarps were taken. The sporocarps were fixed with glutaraldehyde (2%) and osmic acid (1%). After dehydration, the sample was treated with iso-amylacetate, dried to the critical point, and coated with Au.

RESULTS AND DISCUSSION

Sporophytic cycle of *A. filiculoides*

It has been reported (4) that the *A. filiculoides* introduced to China from East Germany appears larger and morphologically distinct from other *A. filiculoides*. Inoculum production presently is confined to vegetative multiplication, which creates storage and transport problems. It is particularly important in northern China.



1. The sporocarps of *Azolla filiculoides*.

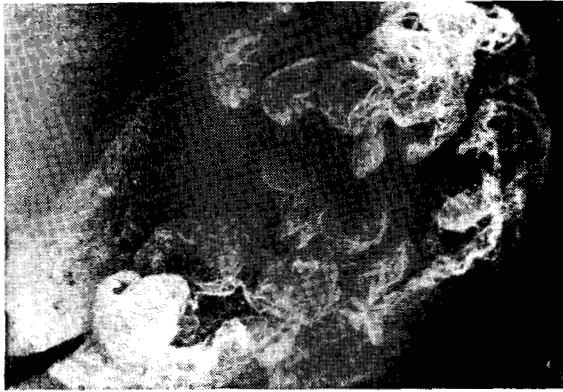

2. Scanning electron micrograph of microsporocarps (X88).



3. Germinating sporocarps of *A. filiculoides*.

We have harvested the sporocarps (Fig. 1), combined them in culture, and followed the sexual cycle through the germination of new sporophytes. Each mature microsporocarp contains eight or more microsporangia (Fig. 2). The megaspore germinates into a female gametophyte (Fig. 3). Some stages



4. The young sporophyte of *A. filiculoides*.

Table 2. N_2 fixation by *A. filiculoides* Lam in paddy soil.

Sampling date	<i>L. polyrhiza</i> L (reference) ^{15}N at. excess (%)	<i>A. filiculoides</i> ^{15}N at. excess (%)	Ndff (%)	Ndff (kg/ha)
19 Jun	1.470	0.881	40.07	1.82
25 Jun	1.670	0.691	58.63	4.92
1 Jul	1.540	0.623	59.55	5.00
7 Jul	1.190	0.614	48.40	6.78
13 Jul	1.200	0.489	59.20	4.98

in the development of the embryo into the young sporophyte are shown in Figure 4. Although we do not know what factors cause *A. filiculoides* to sporulate, we know that sporocarps were found only in summer at Beijing. The sporophyte germination requires about 25-30 d under temperatures 18-25°C and light intensity of 1-1.5 klx.

Estimating BNF

We used *Lemna polyrhiza* as reference plants by using ^{15}N dilution technique (3,5). *L. polyrhiza* (N content 1.17%) at 500 g fresh wt/m² and 650 g *Azolla* (N content 3.25%) fresh wt/m² were applied 35 d before sampling began. The results are shown in Table 2. In the field, N derived from fixation (Ndff) was about 40-60%. About 5 kg N/ha was fixed by *Azolla* within 5-6 d under optimum climatic conditions. The conditions that favor *Azolla* development and N_2 fixation were determined by comparing the N_2 -fixing rate over time. It has been reported (7) that urea is more toxic to *Azolla* than other N sources, so it might affect N_2 fixing rate in the field. The nitrate reductase activity and chlorophyll content in rice leaves did not differ significantly from either treatment. This field experiment was confirmed by pot experiments using same technique.

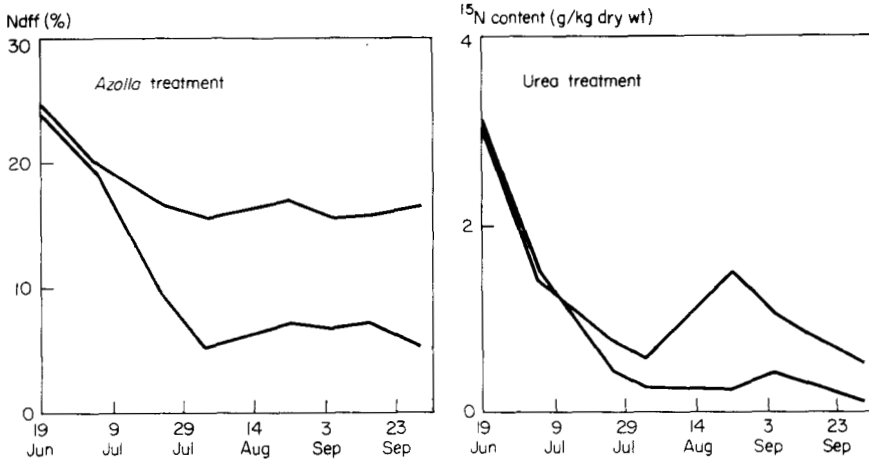

5. % Ndff and ¹⁵N content in *Azolla* treatment and in urea treatment. Incorporation date for *Azolla*: 14 May.

Table 3. Total availability of *Azolla* N and urea N to rice.

Treatment	N yield		Ndff		Ndfs		Ndff		Grain yield (g/plot)
	(mg/plot)		(%)		(mg/plot)		(mg/plot)		
	G ^a	S ^a	G	S	G	S	G	S	
<i>Azolla</i>	1164	945	13.4	17.3	1008	781	156	164	130
Urea	1112	1522	5.9	5.8	1047	1434	65	88	173

^aG = grain, S = straw.

Table 4. Chlorophyll content in the leaves of urea-treated and *Azolla*-treated rice plants (mg/g fresh wt).

Sampling date	Incorporated <i>Azolla filiculoides</i>			Urea		
	Chlorophyll a	Chlorophyll b	a/b	Chlorophyll a	Chlorophyll b	a/b
5 Jul	0.80	0.50	1.60	0.86	0.56	1.54
23 Jul	0.94	0.56	1.68	0.71	0.44	1.62
30 Jul	0.64	0.38	1.67	0.64	0.38	1.67
4 Aug	0.71	0.42	1.76	0.73	0.42	1.74
15 Aug	0.72	0.45	1.66	0.99	0.70	1.46
4 Sep	0.54	0.28	1.90	0.99	0.62	1.59
13 Sep	0.26	0.15	1.68	0.33	0.19	1.74
4 Oct	0.09	0.05	1.68	0.11	0.07	1.68

Measuring availability of *Azolla* N

To measure the availability of *Azolla* N to rice, we incorporated ¹⁵N-labeled *Azolla* (30 kg N/ha) and urea at the bottom of the furrow. *Azolla* (N content 3.25%) at 160 g fresh wt/m² was incorporated 35 d before sampling began. An equivalent amount of urea N was applied to plots 20 d before sampling.

The results are shown in Figure 5 and Table 3. Although grain yield in the urea-treated plots was higher than that in *Azolla*-treated plots, the Ndff in

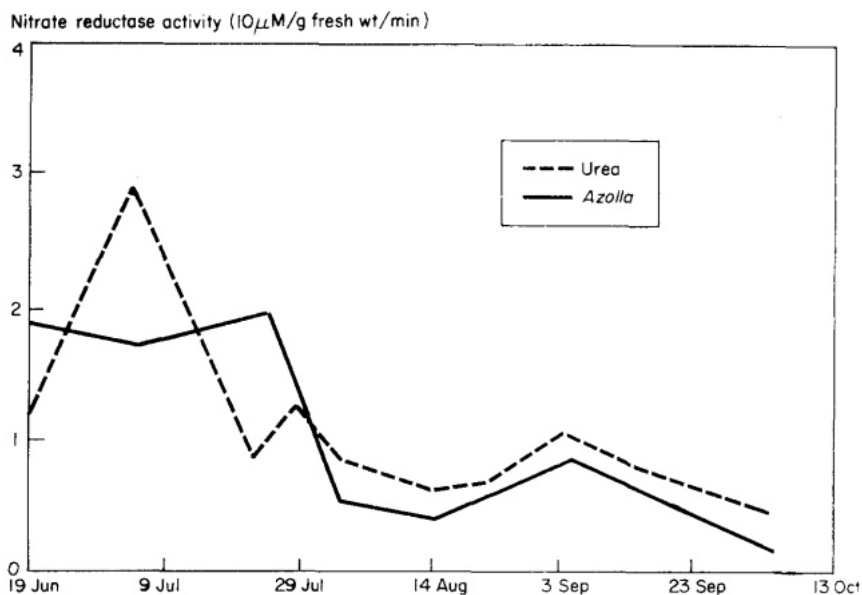

6. Nitrate reductase activity in rice leaves of *Azolla* treatment and urea treatment.

Table 5. NH₄-N content in *Azolla* - treated and urea-treated paddy soils.

Sampling date	(mg/100 g dry soil)	
	Incorporated <i>Azolla</i>	Applied urea
31 May	1.00	1.05
19 Jun	0.88	0.90
5 Jul	0.90	0.90
25 Jul	0.40	0.35
4 Aug	0.11	0.15
13 Sep	0.35	0.29
4 Oct	0.40	0.35

Table 6. Comparison of availability of *Azolla* N and urea N to rice incorporated at panicle initiation; pot experiment, 25 kg soil/pot.

Date	N content in rice (%)		¹⁵ N at. excess (%)		Ndff		Ndff (mg/pot)	
	<i>Azolla</i>	Urea	<i>Azolla</i>	Urea	<i>Azolla</i>	Urea	<i>Azolla</i>	Urea
18 Oct	0.867	0.867	0	0.242	0	11.11	0	40.18
29 Oct	0.467	0.867	0.05	0.225	12.22	10.33	23.09	37.25
8 Nov	0.616	1.545	0.074	0.209	18.09	9.60	45.36	61.94
14 Nov	1.092	1.405	0.052	0.225	12.71	10.33	56.30	60.68

Azolla-treated plots was high. The nitrate reductase activity and chlorophyll content in rice leaves of urea-treated plots were higher than those of *Azolla*-treated plots (Table 4, Fig. 6). The dynamics of NH₄-N content in paddy soil

of both treatments are shown in Table 5. Pot experiment results are shown in Table 6. All the results suggest that:

1. Urea N is taken up by rice more rapidly, but it might be lost from paddy soil, so the $\text{NH}_4\text{-N}$ content resulting from urea treatment is almost the same as in the *Azolla* treatment.
2. The decomposition of *Azolla* is slow in northern China, even though Ndff is high.
3. Incorporating *Azolla* into paddy soils of northern China must be done considerably before transplanting and more *Azolla* biomass is needed.

REFERENCES CITED

1. Arnon, D.I. 1949. Copper enzyme in isolated chloroplast polyphenoxidase in *Beta vulgaris*. Plant Physiol. 24:1-15.
2. Garrett, R.H., and A. Nason. 1969. Further purification and properties of *Neurospora* nitrate reductase. J. Biol. Chem. 244:2870-2882.
3. International Atomic Energy Agency. 1983. A guide to the use of nitrogen-15 and radioisotopes in studies of plant nutrition: calculations and interpretation data. IAEA-TECDOC-288.
4. Peters, G.A., O. Ito, V.V.S. Tyagi, and D. Kaplan. 1981. Physiological studies on N_2 -fixing *Azolla* Pages 343-362 in Genetic engineering symbiotic nitrogen fixation and conservation of fixed nitrogen. Plenum Press, New York.
5. Rennie, R.J., and D.X. Rennie. 1983. Techniques for quantifying N_2 fixation in association with nonlegumes under field and greenhouse conditions. Can. J. Microbiol. 29:1022-1035.
6. You, C.B., et al. 1965. Determination of ^{15}N in biological samples by mass spectrometer [in Chinese]. Atomic Energy 6:535-540.
7. You, C.B., J. W. Li, W. Song, and W. X. Wei. 1981. Effect of nitrogen source on home physiological characteristics of *Azolla*. Pages 719-725 in Proceedings of symposium on paddy soils. Science Press, Beijing.

Summary report of the *Azolla* program of the International Network on Soil Fertility and Fertilizer Evaluation for Rice

I. WATANABE

Soil Microbiology Department
International Rice Research Institute
P.O. Box 933, Manila, Philippines

The International Network on Soil Fertility and Fertilizer Evaluation for Rice since 1979 has conducted collaborative trials to determine the effect of incorporating *Azolla* on rice yield. In 1979 and 1980, 33 trials in 7 countries consisted of 9 common treatments. One crop of *Azolla*, before or after transplanting rice, increased rice grain yield equivalent to that obtained from 30 kg N/ha as urea or ammonium sulfate. In 1981 and 1982, 32 trials in 8 countries consisted of 8 common treatments. Thirty kg N/ha as urea + 2.0 kg *Azolla* fresh wt/m² incorporated before transplanting gave the same yield as that obtained from 60 kg N/ha as urea. Incorporating two crops of *Azolla*, one before and another after transplanting, did not give yields equal to those obtained from 60 kg N/ha as urea. The third set of trials, begun in 1983, consisted of eight common treatments. Because it was difficult to obtain 2.0 kg *Azolla* fresh wt/m² without bringing in *Azolla* from outside the test plots, only 1.5 kg *Azolla*/m² was incorporated along with 30 kg N/ha as urea. *Azolla* biomass was recorded in 58% of the trials. Rice yield increase per unit fresh wt *Azolla* was proportional to the effect of N fertilizer at each site. The average fresh weight of a single crop of *Azolla* was 1.5 kg/m² before transplanting and 1.1 kg/m² after transplanting.

INSFFER, initiated in 1976, is a collaboration program among participating national scientists, the International Rice Research Institute (IRRI), and the International Fertilizer Development Center. Its main objective is to increase fertilizer use efficiency and to improve and maintain soil fertility. INSFFER activities consist of 1) collaborative research trials, 2) training, and 3) site visit tours.

Research trials are formulated and conducted by collaborating scientists. Therefore the trials are part of their national programs. Recognizing the need for trained persons to conduct INSFFER trials, INSFFER began training courses in 1979, and has conducted annual courses since then; 132 persons have participated in the courses. Trials using *Azolla* as a green manure for wetland rice were initiated in 1979. By 1984, the trials had been conducted at 37 sites in 10 countries (Table 1). All collaborators run the common treatments, but some add treatments, depending on their local situations.

Table 1. INSFER *Azolla* experimental sites.

Site no.	Site	Country	Entry			
15	Joydebpur, BRR1	Bangladesh	80	81	82	83
16	Bariari, Joydebpur	Bangladesh	80			
17	Chowara, Comila	Bangladesh	80			
23	Yezin, Pyinmana Department of Agriculture	Burma	81			
13	Fuzhou, Fujian Academy of Agricultural Science	China	79			
131	Putien, Fujian	China	80	82		
10	Cuttack, Indian Rice Research Institute	India	79	80	81	83
11	Madurai, Tamil Nadu	India	79	80		
12	Ludhiana, Punjab Agricultural University	India	79			
19	Chinsurah Rice Research Station	India	80	82	83	
27	Aliyanagar, Tamil Nadu	India	81	82		
28	Tiruruk-kuppam, Tamil Nadu	India	81			
29	Ambasamudram, Tamil Nadu	India	81	82		
35	Coimbatore, Tamil Nadu	India	82	83		
18	Muara, CRI, Bogor	Indonesia	79	80	81	82
38	Maros Research Institute of Food Crops	Indonesia	83			
14	Khumaltar, Lalitpur Department of Agriculture	Nepal	79	80	81	82 83
24	Binalonan, Pangasinan	Philippines	81	82		
25	San Juan, Pototan, Iloilo	Philippines	81			
30	Tabaco, Albay	Philippines	82			
36	Santa Barbara, Pangasinan	Philippines	82			
37	San Nicolas, Gapan, Nueva Ecija	Philippines	83			
21	ORSTOM, Dakar	Senegal	80	81		
26	Richard-Toll, WARDA	Senegal	81	82	83	
20	Gannoruwa, Peradeniya	Sri Lanka	80			
1	Kuan Gut Rice Experiment Station	Thailand	79	80		
2	Pan Rice Experiment Station	Thailand	79	80		
3	Chumpae Rice Experiment Station	Thailand	79	80		
32	Samptong Rice Research Station	Thailand	82	83		
33	Nakonsrithamaraj Rice Research Station	Thailand	82			
39	Ratchburi Rice Experimental Station	Thailand	83			
4	Rangsit Rice Experiment Station	Thailand	79	81	82	
5	Ubon Rice Experiment Station	Thailand	79	80	81	82
6	Pimai Rice Experiment Station	Thailand	79	80		
7	Sakon-Nakorn Experiment Station	Thailand	79	80		
8	Surin Rice Experiment Station	Thailand	79	80	81	82
9	Khon Kaen Experiment Station	Thailand	80			

Each year, IRRI collates and analyzes data from the trials and distributes them to collaborators and other requesting agencies. This paper summarizes 5 years of INSFER *Azolla* trials.

SUMMARY OF TRIALS

1979-80 trials

Rice yield. In 1979, 14 trials were conducted in 5 countries. In 1980, 19 trials were conducted in 8 countries. Nine of the sites were common in each year.

Treatments and averages are shown in Table 2. Nine treatments were common. The trials showed that:

1. incorporating *Azolla* before or after transplanting rice gave yields equivalent to those obtained from 30 kg N/ha as chemical fertilizer;

Table 2. Results of the first (1979-80) *Azolla* trials.

Treatment no.	Treatment	Av rice yield (t/ha) (index) n=30
1	Control. No N, no <i>Azolla</i>	3.00 (100) c
2	30 kg N/ha as urea or ammonium sulfate, in 3 split applications	3.65 (121) b
3	60 kg N/ha as urea of ammonium sulfate, in 3 split applications	4.24 (141) a
4	<i>Azolla</i> incorporated before transplanting rice	3.73 (124) b
5	<i>Azolla</i> incorporated after transplanting rice	3.67 (122) b
6	<i>Azolla</i> inoculated after transplanting, hut not incorporated	3.61 (120) b
7	Combination of treatments 2 and 4	4.15 (138) a
8	Combination of treatments 2 and 5	4.07 (135) a
9	<i>Azolla</i> incorporated before and after transplanting rice	4.09 (136) a
Standard error (between sites)		0.05
Standard error (within sites)		0.05

2. *Azolla* grown with rice as a dual culture without incorporation increased rice yield; and
3. incorporating two crops of *Azolla* increased rice yields equivalent to those obtained from 60 kg N/ha.

In the first and second trials it was evident that incorporating one crop of *Azolla* was equal to 30 kg N/ha as urea or ammonium sulfate.

Azolla biomass and rice increase. Fresh weight of *Azolla* was determined at 17 trials (Table 3). Average fresh weights of *Azolla* harvested before transplanting rice (treatments 4 and 7) were clearly higher than those of *Azolla* harvested after transplanting. Rice yield increase over treatment 2 was lower in treatments 7 and 8 (30 kg N/ha was applied along with *Azolla*), than in other treatments. Correlation coefficient between rice yield increase and *Azolla* biomass was not high, because the effects of *Azolla* on rice yield correlated with the effect of N fertilizer at each site. The higher the effect of N fertilizer, the higher the effect of *Azolla*. This relationship is clearly shown by the high correlation coefficient between rice yield increase per unit weight of *Azolla* and N fertilizer effect.

1981-82 trials

In April 1980, INSFFER scientists agreed to a new plan to compare ways of growing and incorporating *Azolla* at two plant spacings, and to determine if dual culture of rice and *Azolla* in wide row spacing is more effective in increasing *Azolla* biomass and rice yield than ordinary square spacing. A known amount of *Azolla* was incorporated to compare the effect of *Azolla* incorporation with topdressing.

There were 15 trials in 7 countries in 1981. In 1982, 17 trials in 8 countries were included. Experiments were conducted in both dry and wet seasons at some sites. Thirty-five trials were conducted, and at 10 sites the experiments were conducted in both years.

Rice yields. Treatments and average rice yields are shown in Table 4. Incorporating 2.0 kg *Azolla* fresh wt/m² before transplanting in addition to

Table 3. *Azolla* biomass and rice yield increase, 1979-80.

Treatment ^a	Mean of <i>Azolla</i> fresh wt (t/ha) A	Mean of rice yield increase (t/ha) ^b B	Correlation coefficient between A and B	Mean of rice yield increase per unit weight of <i>Azolla</i> (kg/t) C	Correlation coefficient of C with N fertilizer effect ^c	Mean of N fertilizer effects (t/ha)
4 (17)	16.8	0.79	0.30	53	0.53*	0.66
5 (15)	13.0	0.73	0.52*	67	0.41*	0.70
5 (15)	12.1	0.63	0.23	70	0.29	0.70
9 (17)	28.6	0.59	0.47*	43	0.57*	0.96
7 (17)	17.1	0.58	-0.10	38	0.56*	0.40
8 (15)	11.1	0.42	0.40	40	0.79**	0.47

^a Numbers in parenthesis are numbers of sites. ^b In treatments 4, 5, and 9, yield of treatment 1 was subtracted; in treatments 7 and 8, yield of treatments was subtracted. ^c N fertilizer effects for treatments 4, 5, and 6 are the difference between treatments 2 and 1; for treatments 7 and 8, the difference between 3 and 2; for treatment 9, the difference between treatments 3 and 1. * = significantly different at the 5% level, ** = significantly different at the 1% level.

Table 4. Results of second (1981–82) *Azolla* trials.

Treatment no.	Plant spacing (cm)	Treatment	Rice yield (t/ha) (index) n=35
1	20 × 20	No N, no <i>Azolla</i>	2.94 (100) c
2	20 × 20	60 kg N/ha. urea, 3 split applications	4.17 (141) a
3	10 × 40	Same as in treatment 2	4.20 (142) a
4	20 × 20	2.0 kg <i>Azolla</i> fresh wt, incorporated before transplanting + 30 kg N/ha, 3 split applications	4.18 (142) a
5	10 × 40	Same as in treatment 4	
6	20 × 20	<i>Azolla</i> grown before and after transplanting. After full cover, incorporated	4.16 (141) a 3.96 (134) ab
7	10 × 40	Same as in treatment 6	4.04 (137) ab
8	10 × 40	<i>Azolla</i> grown twice only after transplanting	3.88 (132) b
Standard error (among sites)			0.077 0.052

30 kg N/ha gave the same rice yield as that obtained from 60 kg N/ha as urea. Incorporating *Azolla* before and after transplanting gave lower yield than 2.0 kg *Azolla* fresh wt/m² in addition to 30 kg N/ha or 60 kg N/ha as urea. Applying *Azolla* only after transplanting gave lower yield.

In 1979 and 1980, no significant yield differences were found between 60 kg N/ha as inorganic N and two *Azolla* incorporations, one before and one after transplanting. In the second set of trials, there were significant differences, probably because the 1981-82 trials included new sites. Because treatments 3 and 9 in the first set corresponded to treatments 2 and 6 at the second set, results in both trials at the same sites were compared. Trials in 1981-82 gave lower yield for treatment 6 than for treatment 2, whereas in 1979-80, no difference was found. Therefore, it is likely that incorporating one crop of *Azolla* before and another after transplanting gave lower rice yield than applying inorganic N at 60 kg N/ha. Incorporating 2.0 kg *Azolla* fresh wt/m² before transplanting and 30 kg N/ha as urea (3 splits) gave the same yield as 60 kg N/ha as urea. Differences in plant spacing did not affect yield.

Azolla biomass and its effect on rice grain yield. In 19 trials, *Azolla* biomass before incorporation was determined. Biomass production was slightly higher before transplanting than after transplanting. Of 14 trials that recorded biomass of the *Azolla* crop before and after transplanting, 7 recorded higher *Azolla* biomass before transplanting. Average fresh weight of one crop of *Azolla* (14 trials) in treatments 6 and 7 was 1.5 kg/m² before transplanting and 1.1kg/m² after transplanting. No differences were found between plant spacing (treatments 6 and 7).

Azolla biomass before and after transplanting (treatments 6 and 7) and after transplanting (treatment 8) and rice yield increase due to *Azolla* are shown in Table 5. *Azolla* biomass production was lower in treatment 8, where *Azolla* was grown only after transplanting. Rice yield increase was also low in

Table 5. *Azolla* biomass and rice yield increase. 1981-82.

Treatment ^a	Mean of <i>Azolla</i> fresh wt (t/ha) A	Mean of rice yield increase (t/ha) ^b B	Correlation coefficient between A and B	Mean of rice yield increase per unit weight of <i>Azolla</i> (kg/t) C	Correlation coefficient of C with N fertilizer effect	Mean of N fertilizer effect (t/ha)
6 (17)	30.1	0.98	0.07	44	0.47 ^c	1.10
7 (16)	31.5	0.93	0.07	39	0.49*	0.95
8 (16)	21.5	0.70	0.45*	34	0.45	0.92

^a Figures in parentheses are number of sites. ^b Increase over the yield of treatment 1. ^c N fertilizer effect for treatments 7 and 8 was the difference between the yields of treatment 3 and was taken for treatment 6, between 2 and 1. * = significantly different at the 5% level.

treatment 8. No correlation was found between *Azolla* biomass and rice yield increase. Average rice yield increase per unit weight of *Azolla* did not differ among treatments. The yield-increasing effect of *Azolla* was positively correlated with that of N fertilizer.

The relation of yield increase per unit fresh weight of *Azolla* was less clear with the effect of *Azolla* (2.0 kg/m^2) in addition to inorganic N (treatments 4 and 5) than with the effect of N fertilizer (60 kg N/ha). At sites where *Azolla* biomass was determined, there was no difference between treatments 2 and 6 or 3 and 7, indicating that the effect of 2 crops of *Azolla* was equivalent to 60 kg N/ha . At the sites where *Azolla* biomass was determined, *Azolla* growth was probably better than at the sites where it was not. The average weight of two crops of *Azolla* was 30 t/ha in treatments 6 and 7. That 30 t Azolla fresh weight/ha incorporated gave yields equivalent to 30 kg N/ha as urea + 20 t Azolla/ha is surprising. The effect of *Azolla* may have been overestimated, and further study is needed.

1983-84 trials

During 1981-82 trials, most collaborators found it difficult to incorporate $2.0 \text{ kg Azolla biomass/m}^2$ without bringing *Azolla* from outside the experimental plots. Average fresh weight of *Azolla* before transplanting was 1.5 kg/m^2 in 1981-82 trials and 1.6 in 1979-80 trials. Collaborators agreed on decreasing the weight of *Azolla* incorporated from 2.0 to 1.5 kg/m^2 .

Because no difference in rice yield and *Azolla* growth was observed between $20 \times 20 \text{ cm}$ and $10 \times 40 \text{ cm}$ spacings, treatments with $10 \times 40 \text{ cm}$ plant spacing were dropped. A new design was agreed upon for 1984 (Table 6). In 1983, ten or more trials were conducted. At some sites, collaborators found it difficult to grow *Azolla* because of insect damage or deep flooding. At others, *Azolla* was not grown in plots but was brought from outside, or some treatments were deleted because of inadequate *Azolla* growth. Data were satisfactory from only 4 of 10 sites in 1983.

GENERAL DISCUSSION

To analyze the yield data, data on *Azolla* growth are essential. Of 74 reported trials, 43 trials reported biomass of *Azolla* grown or incorporated into the experimental plots. Figure 1 shows the distribution of fresh wt of one crop of *Azolla* at full cover or before incorporation. Although determination of *Azolla* is subject to errors (particularly from moisture fluctuation and soil contamination and from green algae), average values seem reasonable. The approximate average of 15 t/ha is far below the *A. pinnata* biomass obtained under optimum conditions (3). The lower biomass in the field may be due to insect pests, low P availability, and high temperature. Few data are available on N contents of *Azolla* used in these experiments. Assuming $0.2\% \text{ N}$ in fresh *Azolla*, 15 t fresh *Azolla* corresponds to 30 kg N . Assuming that the rice yield increase per unit weight of *Azolla* was 50 kg/t Azolla (Table 3), 15 t fresh

Table 6. Trials in 1983-84.*Treatment*

1. No N, no *Azolla*.
2. 30 kg N/ha as urea, basal (broadcast and incorporated).
3. 60 kg N/ha as urea, 3 split applications.
4. 30 kg N/ha as urea (basal) and 1.5 kg *Azolla* fresh wt/m² incorporated before transplanting.
5. 30 kg N/ha as urea applied as basal dressing and 1.5 kg *Azolla* fresh wt/m² incorporated 3 wk after transplanting.
6. *Azolla* grown once before transplanting rice and incorporated, and grown again after transplanting rice. After each full cover of *Azolla*, it is incorporated and inoculated until 25 d before heading.
7. *Azolla* grown before transplanting rice and incorporated. After transplanting rice, *Azolla* is reinoculated, but not incorporated.
8. *Azolla* grown twice only after transplanting rice.

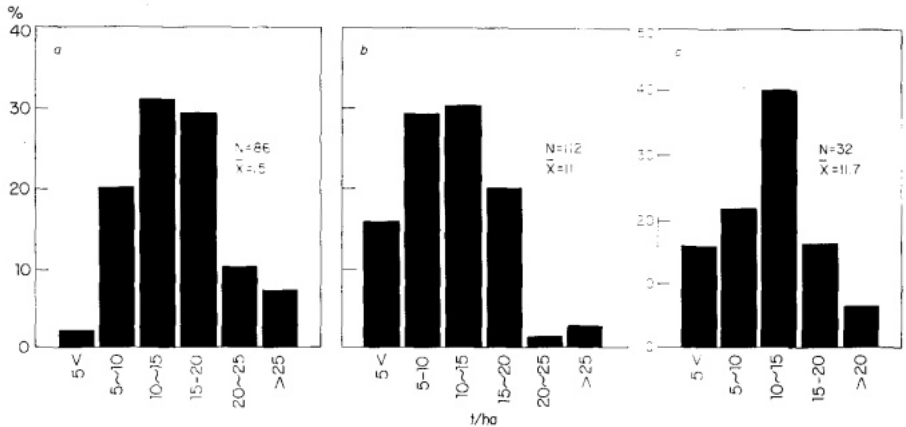

1. Distribution of fresh weight of one crop of *Azolla*: a) before transplanting, b) first crop after transplanting, c) second crop after transplanting.

Azolla was incorporated, and 1 kg of absorbed N produced 50 kg grain, then the estimated absorption ratio of *Azolla* N to rice becomes 50%. This seems higher than the actual value (1). Again, the reported yield increase of *Azolla* might have been overestimated. Trials in 1981-82 showed that rice yield increase by two crops of *Azolla* (3 kg fresh wt/m²), one incorporated before and the second one after transplanting, was slightly less than that obtained from 60 kg inorganic N/ha. The yield-increasing effect of one crop of *Azolla* may be a little lower than that obtained from 30 kg N/ha.

More exact experiments in limited areas may give a clearer picture of the effect of *Azolla* on the growth of rice and its N nutrition. It would be more meaningful if site characterization could explain success or failure of *Azolla* growth and predict fertilizer responses. Site characterization, however, is not always satisfactory. Other INSFFER activities met more or less similar difficulties. To meet the need of better site description, INSFFER organized a workshop on paddy soil classification in April 1983. The fertilizing effect of

Azolla has been demonstrated, but the problem is obtaining enough *Azolla* biomass (about 1.5 kg/m²) with little additional inputs (2). In almost all trials, pesticides and P fertilizers were applied. Some collaborators failed to grow *Azolla*. It may be that the network failed to pinpoint the feasibility of *Azolla* technologies in national programs.

ACKNOWLEDGEMENTS

National program collaborators are gratefully acknowledged: Aung Khin, Burma; G. Arunachalam, India; J. Bunoan, Philippines; A. Coly, Senegal; N. Gunapala, Sri Lanka; Azizul Islam, Bangladesh; S. Kannaiyan, India; C. Kanareugsa, Thailand; Liu Chung-chu, China; O.P. Meelu, India; C. Momuat, Indonesia; S. Parthohardjono, Indonesia; A. Ray, India; P. Reynaud, Senegal; R. Shah, Nepal; P.K. Singh, India; and P. Swatdee, Thailand.

REFERENCES CITED

1. Ito, I., and I. Watanabe. 1984. Availability to rice plants of nitrogen fixed by *Azolla*. *Soil Sci. Plant Nutr.* 30:480-485.
2. Kikuchi, M., L.D. Haws, and I. Watanabe. 1983. Economic evaluation of *Azolla* use in rice production. Pages 569-592 in *Organic matter and rice*. International Rice Research Institute, P.O. Box 933, Manila, Philippines.
3. Watanabe, I., and S. S. Berja. 1983. The growth of four species of *Azolla* as affected by temperature. *Aquat. Bot.* 15:175-185.

DISCUSSIONS

WEN QUI-XIAO: In the trials you discussed, was any phosphorus or potash fertilizer applied to the control?

WATANABE: Phosphorus was applied in all treatments to stimulate *Azolla* growth. The amount differed depending on the frequency of *Azolla* growth. Potassium was applied in most trials.

ESKEW: Did the control treatment include a simulated incorporation to evaluate the effect, of soil disturbance?

WATANABE: We will include the simulated incorporation treatment as one of control treatments in the next trials.

SHIOMI: I understand that an addition of *Azolla* plants increases rice yield. Will you please mention the effect of *Azolla* input into the ricefield on quality of rice grain (for example, some nutritive values)? Are the effects better than those of chemical fertilizers only?

WATANABE: So far, no data are available.

Insect pests of *Azolla* in the Philippines

O. MOCHIDA, Y. YOSHIYASU, AND D. DIMAANO

Department of Entomology

International Rice Research Institute

P.O. Box 933, Manila, Philippines

There are 12 insect pests of *Azolla* in the Philippines: five Diptera, three Coleoptera, and four Lepidoptera. The most important among them are the Lepidoptera: spinningworm *Ephestiopsis vishnu* and caseworm complex, *Elophila enixalis*, *El. nigrabalis*, and *El. responsalis*. The spinningworm and its life cycle are described, and the diagnostic characters of three caseworms and their life cycles are shown. Light trap catches of the caseworm complex and spinningworm adults were recorded at IRRI from Jun to Dec 1984. Their larval (2d instar and older) and pupal populations on *Azolla microphylla* and *A. pinnata* from Nov 1983 to Dec 1984 are shown. The standing biomass of *A. microphylla* (IRRI 418) averaged 1.03 kg fresh wt/m² in insecticide-treated plots and 0.67 kg/m² in untreated plots. The standing biomass of *A. microphylla* (IRRI 5) averaged 0.67 kg/m² in treated plots and 0.45 kg/m² in untreated plots. Spinningworm larval and pupal populations in untreated plots averaged 146/m² on *A. microphylla* and 135/m² on *A. pinnata*. Caseworm larval and pupal populations averaged 57/m² on *A. microphylla* and 48/m² on *A. pinnata*. Yield losses from insect pests on *A. microphylla* averaged 35% (ranged 6-74%) and 31% (range 13-57%) on *A. pinnata*. Yield loss was higher on *A. microphylla*, but biomass production still exceeded that of *A. pinnata* by 0.4 kg/m² in treated plots and 0.2 kg/m² in untreated plots.

Worldwide at least 31 insect species have been reported as pests of *Azolla*: 13 Diptera (all chironomids), 4 Coleoptera (a chrysomelid and 3 curculionids), 10 Lepidoptera (all pyralids), 2 Homoptera (both aphids), and 2 Orthoptera (1 paulinid and 1 tetrigid) (2, 6, 9, 11). In India, Vietnam, and China, *Cryptoblades*, *Elophila* (= *Nymphula*), and chironomids are important pests of *Azolla* (7). In Thailand, *Azolla* loss due to insect pests is estimated at 37-80% (5).

In the Philippines, 3 Diptera chironomids (*Chironomus crassiforceps*, *C. javanus*, and *C. kiiensis*) and a Coleoptera curculionid (*Nanophyes* sp.) have been reported as pests of *Azolla* (4). Kikuchi et al (6) reported that insect pests were serious constraints to *Azolla* production in South Cotabato, Mindanao, although they did not identify important species. Pyralid larvae were first identified as serious pests of *Azolla* in South Cotabato and Laguna in 1982 (4). Spinningworms and caseworms have been regarded as serious pests of *Azolla* in Luzon during summer (I. Watanabe, IRRI, pen. comm.).

Based on 4 species described in the literature (3), and 9 species we confirmed from Dec 1982 to Feb 1985, we consider there are 12 insect pests of *Azolla* in the Philippines. (One of the four pests described in the literature was the same as one of the nine we confirmed.) Their distribution in the Philippines, level of damage if known, and known predators are listed below.

- A. Diptera, Chironomidae
1. *Chironomus crassiforceps* Kieffer
Distribution: Luzon, Leyte, Mindanao
Damage to *Azolla*: Negligible
 2. *Chironomus javanus* Kieffer
Distribution: Luzon
 3. *Chironomus kiiensis* Tokunaga
Distribution: Luzon, Leyte, Mindanao
Damage to *Azolla*: Negligible
 4. *Polypedilum anticum* Johannsen
Distribution: Luzon, Leyte
Damage to *Azolla*: Negligible
 5. *Polypedilum suturalis* Johannsen
Distribution: Luzon
Damage to *Azolla*: Negligible
- B. Coleoptera, Curculionidae
6. *Apion* sp.
Distribution: Luzon (Ifugao)
Damage to *Azolla*: Negligible
 7. *Bugeus affinis* Hustache
Distribution: Luzon
 8. *Nanophyes insularis* Hustache
Distribution: Luzon
- C. Lepidoptera, Pyralidae
9. *Ephestiopsis vishnu* Roesler et Küppers [spinningworm]
Distribution: Luzon, Mindoro, Panay, Negros, Cebu, Bohol, Palawan, Leyte, Mindanao (Fig. 1)
Hosts: *Azolla microphylla* and *A. pinnata*
Damage to *Azolla*: Usually most serious
Natural enemies': *Apanteles* sp. (Hymenoptera, Braconidae)
W.R.M. Mason, pers. comm., 20 Dec 1984) parasitizes the larvae/pupae of the pyralid and parasitism was 1.5% (12 wasps from 856 hosts) at IRRI in 1983 and 1984)

¹ In the Philippines, there are five predators of larvae. *Berosus* sp. (Coleoptera, Hydrophilidae), *Cybister tripunctatus orientalis* Gschwerdtner (Coleoptera, Dystiscidae), *Hydrophilus affinis* Sharp (Coleoptera, Hydrophilidae), *Laccophilus* nr. *insularis* (Gentili) (Coleoptera, Dystiscidae), and *Sternolophus* sp. (Loleoptera, Hydrophilidae). Two spiders are known to prey on adults: *Argiope catenulata* (Dolleschall) (Araneae, Araneidae) and *Lycosa pseudounmulata* (Boesenberg et Strand) (Araneae, Lycosidae) (J.A. Litsinger and A.T. Barrion, pers. comm.).

10. *Elophila enixalis* (Swinhoe) [caseworm]
Isopterix enixalis
Nymphula osculatorix Meyrick
Nymphula enixalis
 Distribution: Luzon, Mindoro, Leyte, Negros, Mindanao (Fig. 2)
 Hosts: Larvae feed on *A. microphylla* and *A. pinnata*. Agassiz (1) recorded larvae feeding on many aquatic plants such as *Vallisneria*, *Synnema*, *Echinodorus*, *Potamogeton*, and others.
 Damage to *Azolla*: Serious
 Natural enemies: *Amauromorpha accepta metathoracica* Ashmead (Hymenoptera, Ichneumonidae), a parasitoid on larvae of *El. enixalis* and *El. nigrabalis*. Parasitism was estimated at less than 1% at IRRI in 1984. *Diplonychus rusticus* (Fabricius) (Heteroptera, Belostomatidae) was recorded as a predator of caseworm complex larvae at IRRI in 1983 and 1984.
11. *Elophila nigrabalis* (Caradja) [caseworm]
Nymphula nigrabalis
 Distribution: Luzon, Mindoro, Panay, Negros, Cebu, Bohol, Leyte, Mindanao (Fig. 2)
 Host: *A. microphylla*, *A. pinnata imbricata*, and *A. pinnata pinnata*. Speidel (8) recorded *Lemna paucicostata*, *Spirodela polyrhiza*, *Salvinia natans*, *Marsilea quadrifolia*, *Eichhornia crassipes*, and *Pistia stratiotes* as hosts.
 Damage to *Azolla*: More serious than *El. enixalis* and *El. responsalis*
 Natural enemies: *Amauromorpha accepta metathoracica* Ashmead (Hymenoptera, Ichneumonidae), and *Diplonychus rusticus* (Fabricius) (Heteroptera, Belostomatidae).
12. *Elophila responsalis* (Walker) [caseworm]
Nymphula responsalis
 Distribution: Luzon, Panay, Leyte, Cebu, Mindanao (Fig. 2)
 Hosts: *A. microphylla*, *A. pinnata*, *Lemna paucicostata*, and *Spirodela oligorrhiza*. *Pistia* sp. in Thailand (10)
 Damage to *Azolla*: less serious than *E. nigrabalis*
 Natural enemy: *Diplonychus rusticus* (Fabricius) (Heteroptera, Belostomatidae)

DESCRIPTION AND BIOLOGY OF LEPIDOPTEROUS PESTS

Four Lepidoptera are insect pests of *Azolla*. They are the spinningworm *Ephestiopsis vishnu* and three species of *Elophila* (caseworm complex). The adults of these four pests are shown in Figure 3. *Elophila enixalis*, *El. nigrabalis*, and *El. responsalis* can be distinguished by differences in the heads of 5th-instar larvae (Fig. 4), and by differences in wing patterns and genitalia of adult males (Table 1, Fig. 5) *El. nigrabalis* larvae prefer to feed on *Azolla*.

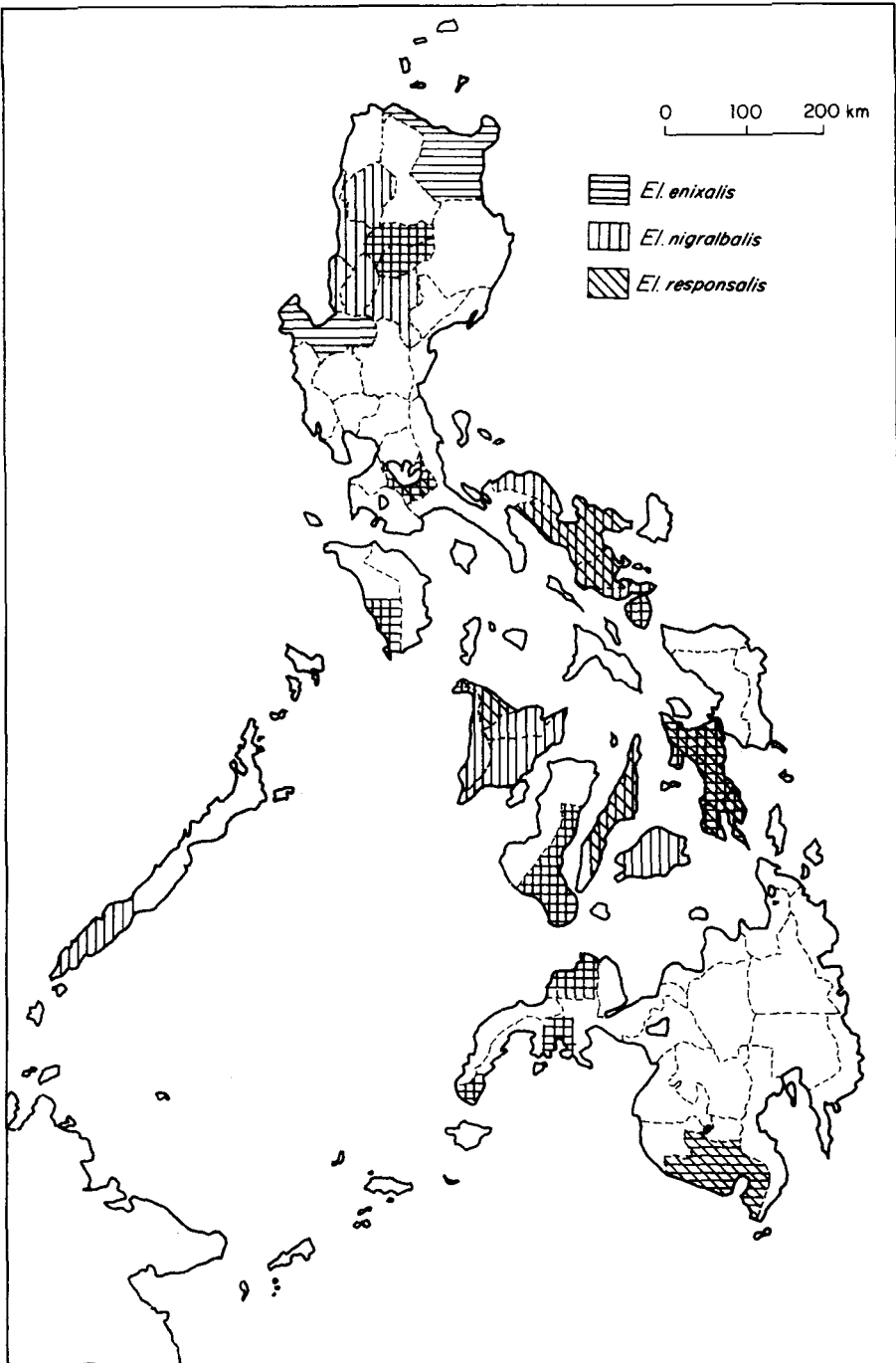

2. Distribution of three caseworms *Elophila* spp. on *Azolla* in the Philippines.

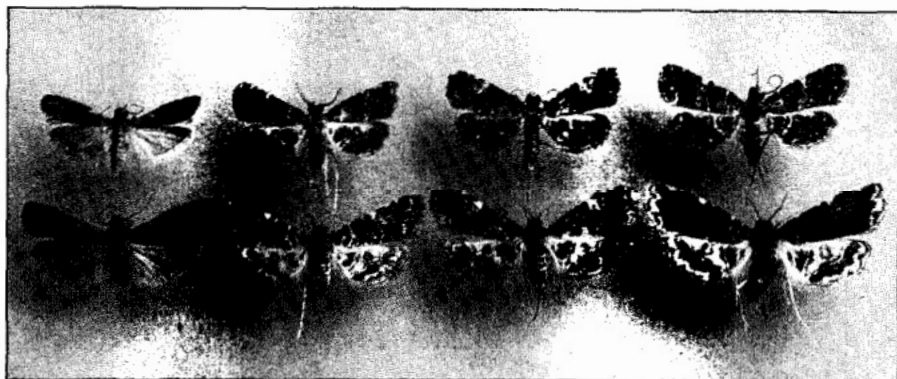

3. Adult females of pyralid pests on *Azolla*.

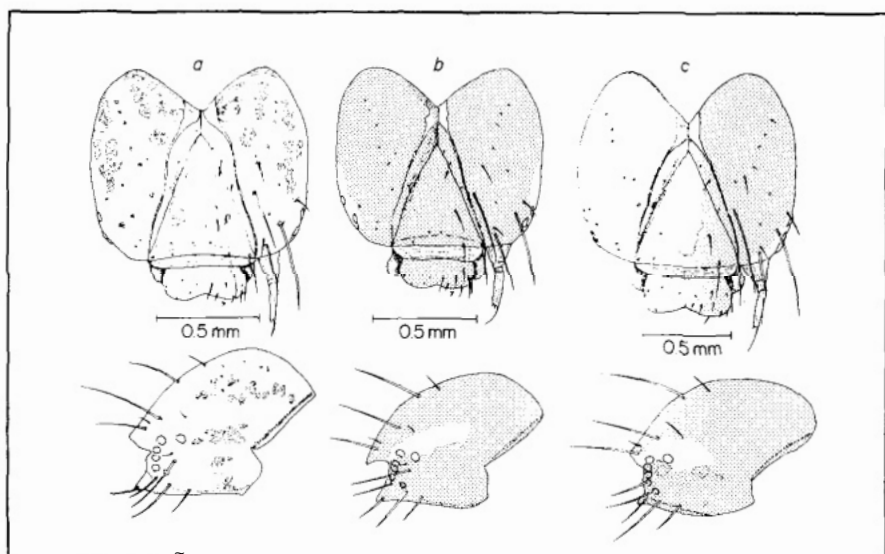

4. Fifth-instar larval heads of *Elophila* spp. a) *El. enixalis*; b) *El. nigralbalis*; c) *El. responsalis*.

El. enixalis feed on *Azolla* and other aquatic plants. *El. responsalis* feed on *Lemna*, *Spirodela*, and other vegetation such as decayed tree leaves.

***Ephestiopsis vishnu* Roesler et Koppers**

Description. Eggs are oval, somewhat translucent, about 0.35 mm long and 0.29 mm wide.

Newly hatched larvae are whitish, 1.1-1.2 mm long and 0.2 mm wide. The 2d-instar larvae are yellowish, and the 3d-instar larvae are pale greenish dorsally. The 4th- and 5th-instar larvae are dark green with yellow-brown heads.

Table 1. Identifying characters of adult males of three *Elophila* species.

	<i>El. enixalis</i>	<i>El. nigrabalis</i>	<i>El. responsalis</i>
<i>Forewing</i>			
Posterior portion of postmedial line	Evenly curved	Angulate at middle	Almost straight
Submarginal white area	Interrupted at middle	Almost absent	Distinct, continuous
Length	5.2 mm	5.4 mm	5.9 mm
<i>Hindwing</i>			
Medial line	Evenly curved	Almost straight	Almost straight
Medial white area	Completely suffused with dark brown	Partly suffused with dark brown	Present
Postmedial line	Sinuate	Angulate at middle	Weakly sinuate
<i>Genitalia</i>			
Tegumen	Longitudinal axis shorter than width, without a dorsal ridge	Longitudinal axis shorter than width, without a dorsal ridge	Longitudinal axis the same as width, with a dorsal ridge
Valva	Ampulla with 5 (4 in some cases) well developed sickle-like processes	Ampulla with 3 developed sickle-like processes	Ampulla without sickle-like processes
Phallus	With 2 plates of cornuti one of which is furnished with a thick thorn	With 2 plates of cornuti, one of which is furnished with a small thorn	Without cornuti

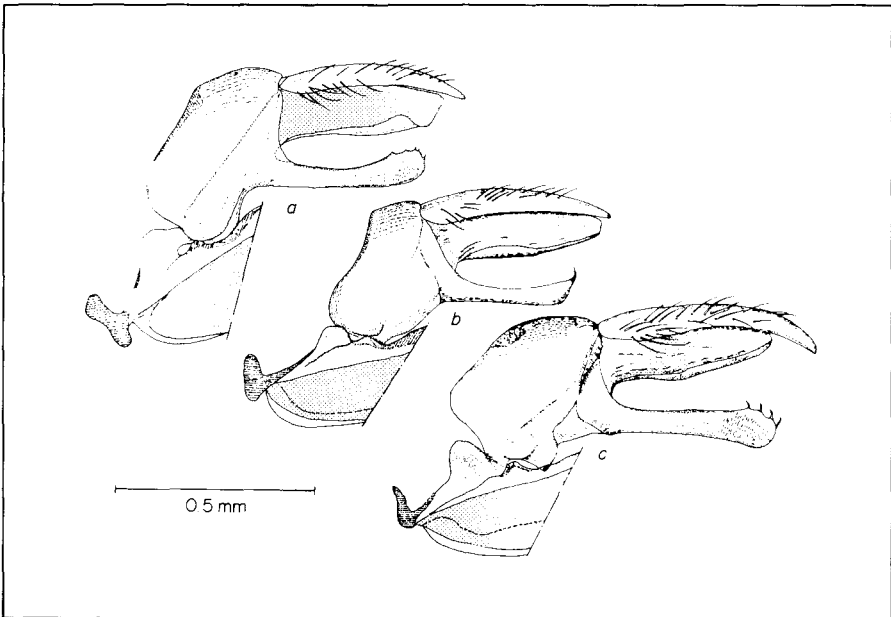
**5. Male genitalia of *Elophila* spp. Whole genitalia, lateral view. a) *El. enixalis*; b) *El. nigrabalis*; c) *El. responsalis*.**

The pupae are brown, about 6-7 mm long, with slightly expanded spiracles.

Forewings of males are grayish dark-brown, those of females a little darker.

Life cycle. The egg stage is 3 d, larval stage 12 d, and pupal stage 5 d on *A. pinnata* at $27 \pm 3^\circ\text{C}$. The period from egg deposition to emergence is about 20 d.

Females deposit an average of 311 (range 246-370) eggs. Adult male moths survive 3 or 4 d; adult females about 5 d (range 3-7 d).

***Elophila enixalis* (Swinhoe)**

Description. Eggs are oval, somewhat flattened, and creamy white.

First-instar larvae have yellowish-white thoracic and abdominal parts with pale-brown heads. The anterior and posterior portions of the bodies of 3d-instar larvae are brownish. Their heads are pale brown, with obscure, darker spots at the bases of setae. The bodies of 4th- and 5th- (or 6th-) instars are milky-white with anterior and posterior portions somewhat darker; heads remain pale brown. The 3d-instar and older larvae develop water-resistant structures on their body surfaces but no tracheal gill. Most larvae pupate after the 4th molting, but a few pupate after the 5th molting. Pupae are uniformly pale brown.

Adult males are light brown to fulvous; females are slightly darker.

Life cycle. The egg stage is 4 d, larval stage 21 d, and pupal stage 6 d on *A. pinnata* at $27 \pm 3^\circ\text{C}$. The period from egg deposition to emergence is about 31 d. Most larvae pupate after the fourth molting, but a few pupate after the fifth molting. Females deposit an average of 252 (range 196-346) eggs. Adult male and female moths survive 4 or 5 d (range 2-7 d).

***Elophila nigralbalis* (Caradja)**

Adult females usually deposit their eggs singly on the underside of lower leaf lobes below the water surface, unlike the females of *El. enixalis* and *El. responsalis*, which deposit egg masses. The egg stage is about 5 d, larval stage 19 d, and pupal stage 7 d on *A. pinnata* at $27 \pm 3^\circ\text{C}$.

The period from egg deposition to emergence is about 31 d. Most larvae pupate after the fourth molting, but a few pupate after the fifth molting. Females deposit an average of 236 eggs (range 54-414 eggs). Adult male moths survive for about 3 d (range 1-4 d); females survive for about 4 d (range 2-6 d).

***Elophila responsalis* (Walker)**

The egg stage is 5 d, larval stage 22 d, and pupal stage 7 d on *A. pinnata* at $27 \pm 3^\circ\text{C}$. The period from egg deposition to emergence is about 34 d. Most larvae pupate after the fourth molting, but a few pupate after the fifth molting. Females deposit an average of 344 eggs (range 253-478 eggs) Adult male moths survive for about 3 d (range 1-6 d); females survive for about 5 d (range 3-6 d).

SEASONAL ABUNDANCE OF FOUR MAJOR INSECT PESTS

Seasonal fluctuations of adult moths caught by a special light trap (10 W blue-black fluorescent lamp equipped with an electric fan) are shown in Figure 6. The number of adults of the caseworm complex caught was higher in July than in other months, whereas that of the spinningworm was higher in June.

Larval (2d- to final-instar) and pupal populations of the caseworm complex and the spinningworm were monitored on *A. microphylla* (IRRI Acc. No. 418) and *A. pinnata* (No. 5).

A. microphylla was inoculated in 8 plots (2.5 × 3.5 m) at IRRI farm at a rate of 0.5 kg fresh wt/m² on 16 Oct 1983. All plots were cleaned between 30 Mar and 15 Apr 1984 and reinoculated on 16 Apr. Four plots were treated with monocrotophos 30% EC at a rate of 0.75 kg ai/ha at 2 wk intervals. Whenever *Azolla* grew well and covered more than 75% of the water surface, enough *Azolla* was removed to keep at least 25% of the water surface open.

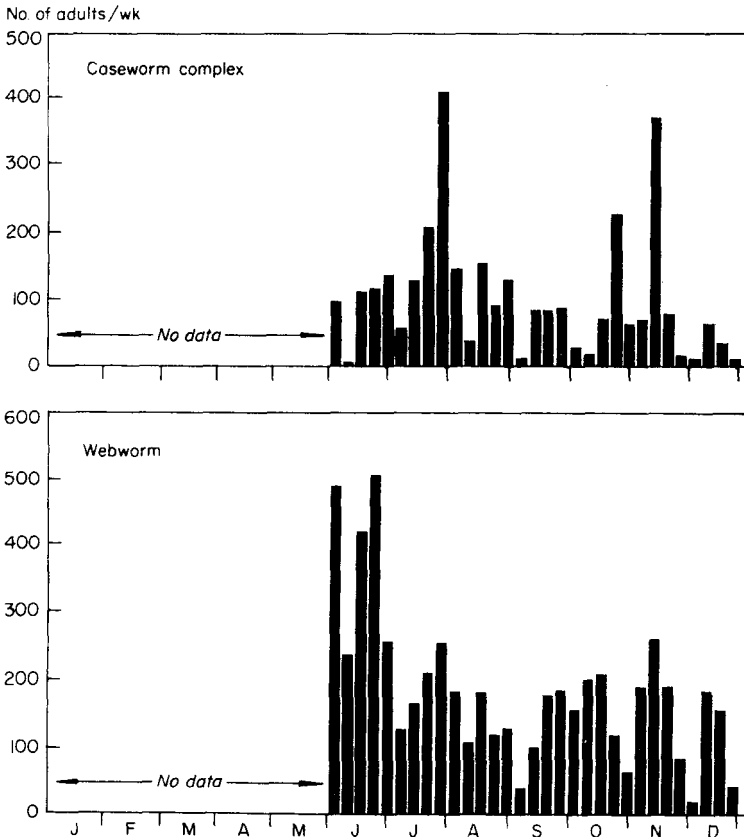

6. Light trap catches of the caseworm complex (*El. enixalis*, *El. responsalis*, and *Elophila* sp.) and webworm at IRRI, 1 Jun-31 Dec 1984.

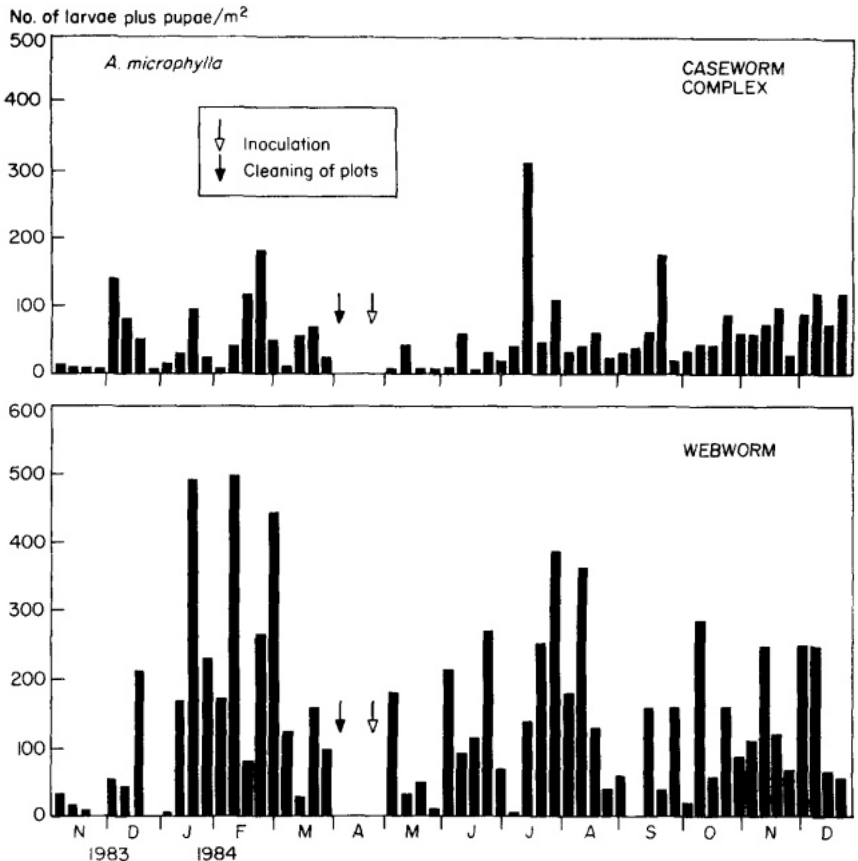

7. Weekly larval and pupal samples of the caseworm complex and webworm on *A. microphylla* in untreated plots at IRR1 from November to December 1984.

Neither larvae nor pupae of caseworm complex or spinningworm were found in treated plots. The larval and pupal populations of both, however, varied considerably in untreated plots (Fig. 7).

A. pinnata was inoculated in the same manner as *A. microphylla*. The larval and pupal populations of the caseworm and the spinningworm on *A. pinnata* are shown in Figure 8.

AZOLLA BIOMASS AND YIELD LOSS

Standing biomass in insecticide-treated and untreated plots of *A. microphylla* are shown in Figure 9, and those of *A. pinnata* in Figure 10.

A. microphylla covered more than 75% of the water surface of treated plots 9 times between November 1983 and December 1984. Enough was removed each time to reduce the area covered back to 75%. Total removed covered 9 m²

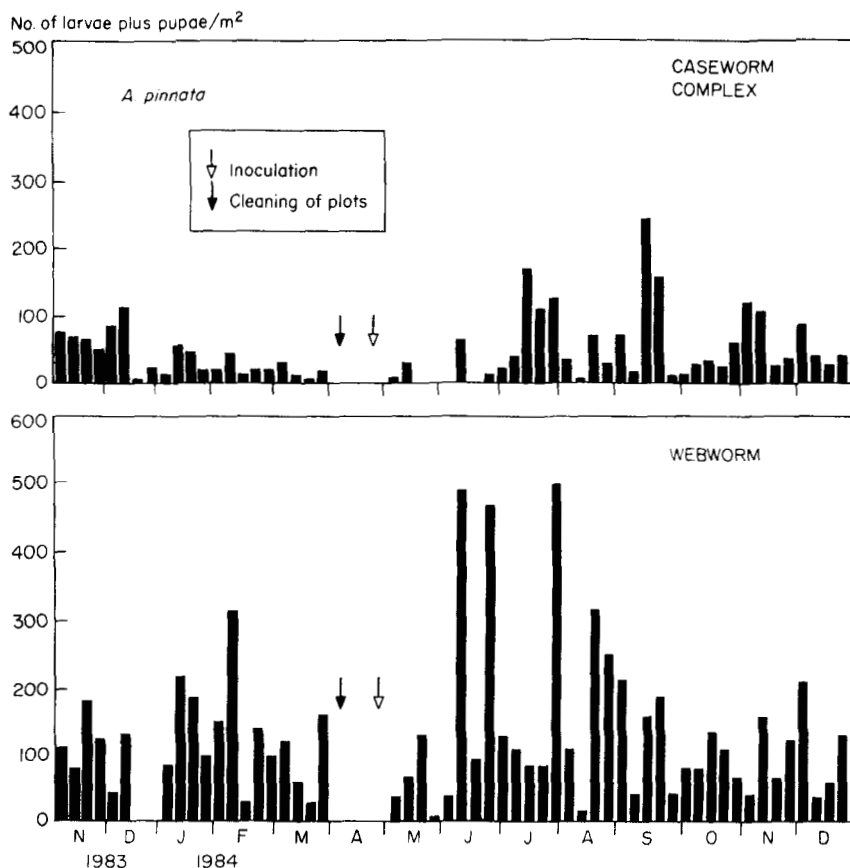

8. Weekly larval and pupal samples of the caseworm complex and webworm on *A. pinnata* in untreated plots at IRRRI from November 1983 to December 1984.

and fresh wt was 3.85 kg. Standing biomass averaged 1.03 kg/m² in treated plots and 0.67 kg/m² in untreated plots.

A. pinnata was removed eight times. Total removed covered 8 m² and total weight was 1.73 kg fresh wt. Standing biomass averaged 0.47 kg/m² in treated plots and 0.45 kg/m² in untreated plots (Table 2).

Azolla grew well only in treated plots; in untreated plots it never covered more than 75% of the water surface.

Yield loss caused by insect pests was estimated by the following formula:

$$\text{Yield loss (\%)} = (1.00 - \frac{\text{standing-biomass values in untreated plots}}{\text{standing-biomass values in treated plots}}) \times 100$$

The weekly yield loss averaged 35% or *A. microphylla* and 31% or *A. pinnata* (Table 2).

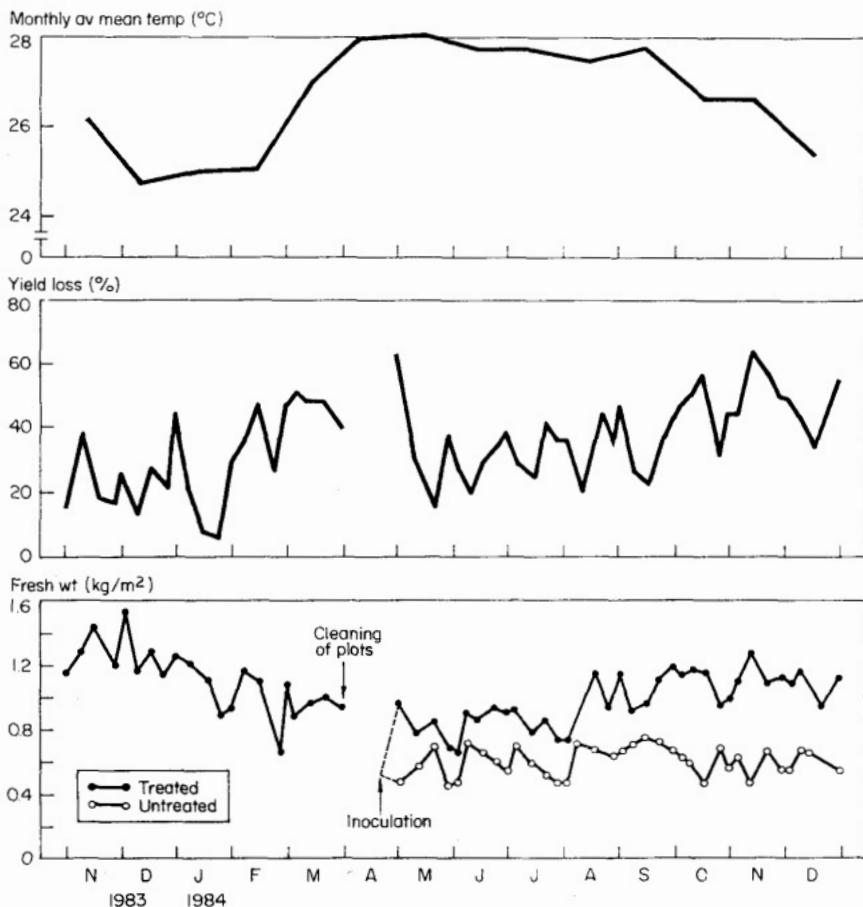

9. *Azolla microphylla* standing biomass in insecticide-treated and untreated plots and yield loss at IRRI farm, November 1983-December 1984.

EFFECTIVE INSECTICIDES AGAINST 4TH-INSTAR LARVAE OF THE SPINNINGWORM AND THE CASEWORM COMPLEX

Nine insecticides were laboratory-tested in liquid formulations at 0.75 kg ai/ha. Against spinningworms, methomyl 18% EC showed 80% mortality after 48 h, and monocrotophos 30% EC showed 75% mortality. Against caseworms, methomyl 18% EC showed 88% mortality; triazophos 40% EC, 85%; diazinon 20% EC, 75%; carbofuran 12% F, 73%; and monocrotophos 30% EC, 70%.

Seven granular insecticides, laboratory-tested at a concentration of 50 ppm ai, showed 85% mortality or higher against spinningworms. They were: phenthoate + MIPC 3 + 3% G and propaphos 5% G, 98%; cartap 4% G and ethoprop 10% G, 95%; carbofuran 3% G and diazinon 5% G, 93%; and benfuracarb 5% G, 85%. Isazophos 10%, carbosulfan 5% G, and profenofos 3% G showed 78% or less mortality.

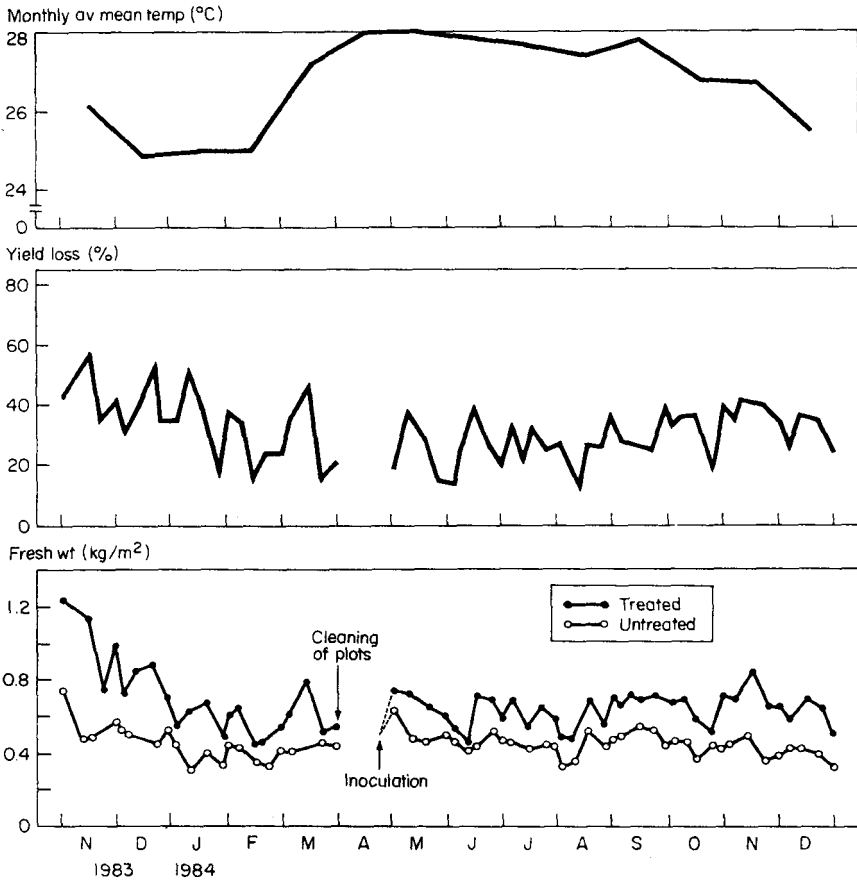

10. *Azolla pinnata* standing biomass in insecticide-treated and untreated plots and yield loss at IRRI farm, November 1983-December 1984.

ACKNOWLEDGMENT

We wish to thank Dr. I. Watanabe, IRRI, who helped us in various ways during the course of the work; and the following for identifying the insects: Drs. H. Hashimoto, Sizuoka, Japan (Chironomidae); S. Miyamoto, Hukuoka, Japan (*Diplonychus rusticus*); S. Momoi, Kobe, Japan (*Amauomorpha accepta metathoracica*); W.R.M. Mason, Quebec, Canada (*Apanteles* sp., very probably new species); Prof. Dr. R.U. Roesler, Karlsruhe, Germany (*Ephestiopsis vishnu*); and K. Morimoto, Hukuoka, Japan (3 curculionids).

Table 2. Standing biomass of two *Azolla* species, larval and pupal populations of the spinningworm and the caseworm complex, and yield loss at IRRI farm from November 1983 to December 1984.

Insecticide treatment	Standing biomass (kg fresh wt/m ²)		(No. larvae + pupae)/m ²				Estimated yield loss (%)	
			Spinningworm		Caseworm			
	Av	Range	Av	Range	Av	Range	Av	Range
<i>A. microphylla</i>								
Treated	1.03	0.62-1.53	0.0	—	0.0	—	34.6	5.8-64.2
Untreated	0.67	0.43-1.19	146.0	0.0-522.3	56.8	2.5-315.5		
<i>A. pinnata</i>								
Treated	0.67	0.44-1.24	0.0	—	0.0	—	31.2	13.1-57.4
Untreated	0.45	0.30-0.72	134.8	5.8-621.5	48.0	0.0-246.5		

REFERENCES CITED

1. Agassiz, R.D. 1978. Five introduced species, including one new to science, of China Mark moths (Lepidoptera: Pyralidae) new to Britain. Entomol. Gaz. 29:117-127.
2. Guangdong Academy of Agricultural Science, Soil and Fertilizer Res. Inst. 1980. [*Azolla filiculoides*] (in Chinese) Guangdong. 49 p.
3. International Rice Research Institute. 1983. Aquatic invertebrate fauna in rice field. Annual report for 1982. P.O. Box 933, Manila, Philippines. p. 180-181.
4. International Rice Research Institute. 1983. Insect pests of *Azolla*. IRRI research highlights for 1982. P.O. Box 933, Manila, Philippines. p. 99-100.
5. Katanyukul, W., C. Hengsawad, P. Sawatdi, W. Seetanun, and C. Phaewpolsong. 1983. Insect damage on *Azolla* in Thailand. Int. Rice Res. Newsl. 8(17):11-12.
6. Kikuchi, M., I. Watanabe, and L.D. Haws. 1954. Economic evaluation of *Azolla* use in rice production. Pages 569-592 in Organic matter and rice. International Rice Research Institute, P.O. Box 933, Manila, Philippines. 631 p.
7. Lumpkin, T.A., and D.L. Plucknett. 1982. *Azolla* as a green manure: use and management in crop production. Westview Press, Boulder, Colorado, USA. 230 p.
8. Speidel, W. 1984. Revision der Acentropinae des palaearktischen Faunengebietes (Lepidoptera: Crambidae). Universitat Karlsruhe, Germany. 157 p.
9. Takara, J. 1981. Insect pests on *Azolla pinnata* at Bankhen, Thailand. Int. Rice Res. Newsl. 6(4):12-13.
10. Yoshiyasu, Y. 1983. A study of Thailand Nymphulinae (Lepidoptera: Pyralidae). 2. Notes on genera *Nymphula* and *Paraponyx* with description of a new species. Tinea 11:117-124.
11. Zhejiang Academy of Agricultural Sciences, Soil and Fertilizer Res. Inst. 1981. [*Azolla filiculoides*] (in Chinese) Beijing. 156 p.

DISCUSSION

DIARA: Can you confirm that any of the *Azolla* pests are not pests of rice?

MOCHIDA: In the Philippines, insect pests of *Azolla* never attack rice.

KANNAIYAN: 1) Do you have any information on the resistance or tolerance of different *Azolla* species to insect pests or snails? 2) Which is the most serious pest of *Azolla*? 3) Do you think the plant protection measures for the rice crop are sufficient to control insect pests in an intercropping system with *Azolla*? 4) What ecological conditions favor the outbreak of insect pests?

MOCHIDA: 1) In the Philippines, insect pests eat some *Azolla* species more rapidly than they do others, but eventually they eat all of them. That means there is no *Azolla* species or main tolerant or resistant to *Ephestiopsis vishnu* as far as we observed. 2) In the Philippines, *Ephestiopsis vishnu* is usually much more important than snails. 3) After rice is transplanted, yes. 4) I do not know.

LADHA: Do you think that if we continuously use *Azolla*, the number and types of *Azolla* pests will increase?

MOCHIDA: Yes, whenever and wherever we maintain *Azolla* continuously on a large scale, pest problems may increase.

LIN SHIH-RU: You mentioned many names of natural enemies of *Pyralis* and *Nymphula*. Would you write them out for me?

MOCHIDA: *Pyralis* is an invalid genus name. I will try to list them.

LUMPKIN: Have you ever applied benomyl, PCNB, or other fungicides to prevent insect attack on *Azolla*?

MOCHIDA: No.

GREENLAND: What quarantine procedures should be followed in distributing *Azolla*?

MOCHIDA: Against insect pests on *Azolla pinnata imbricata* phenthoate + MIPC, prothoos, ethoprop, carbofuran, and benfuracarb granules are added to *Azolla* colonies at a rate of 25 ppm, Against those on *A. microphylla*, they are used up to a maximum rate of 50 ppm. Diazinon should be used at lower rates. The phytotoxicity of these insecticides is higher on *A. pinnata imbricata* than on *A. microphylla*.

Determination of amount of N₂ fixation and change in N₂-fixing activity of *Azolla* in natural environment

LI ZHUO-XIN, ZU SHOU-XIAN, MAO MEI-FEI,
WANG FU-LAI, AND ZHAO BING-BO
Institute of Soil and Fertilizers
Zhejiang Academy of Agricultural Sciences
Hanzhou, Shejiang, China

Variations in the N₂-fixing activity of *Azolla* by species and weather, and the effect of light intensity and temperature on *Azolla* N₂-fixing activity were studied. A direct method for measuring N₂-fixing activity without changing the ecological conditions or growth of *Azolla* is described. An experimental formula for calculating the daily amount of N₂ fixed by *Azolla* (g/g dry wt) is given:

$$W = \frac{4(b+c) + 8(a+d)}{3} \times 28$$

where a, b, c, and d are the N₂-fixing activity (mol C₂H₄/g per h) of *Azolla* successively determined at 0600, 1000, 1400, and 1800 h, respectively. The formula was derived from the successive determination of N₂-fixing activity in the natural environment. Optimum light intensity and growth temperature for N₂-fixing varies by *Azolla* sp. and season. That is why the amount of N₂ fixed by *Azolla* should be calculated on the basis of successive determinations. The reaction time for the determinations was found to be 10 min and a factor to convert the amount of fixed N₂ from that of reduced C₂H₂ was found to be 3. For gas chromatographic analysis, the ratio of N_{C₂H₄}/N_{C₂H₂} (content ratio) was not proportional to H_{C₂H₄}/H_{C₂H₂} (peak height ratio). This ratio should be determined experimentally.

Many researchers have reported the methods for measuring N₂-fixing activity of *Azolla* by acetylene reduction techniques (1, 2, 4, 8, 9, 12). There were, however, some scientific deficiencies in those methods. For example, the value of N₂-fixing activity of *Azolla* obtained from destructive measurement or from a one-time measurement differed greatly from the actual value in the natural environment. To understand regular variations of N₂-fixing activity of *Azolla* and the actual amount of N₂ fixation in the natural environment, we suggested in 1979 a direct measurement method that does not change the growth or environment of *Azolla* (7). At that time, the relation between N₂-fixing

activity of various *Azolla* species under various natural light intensities, temperatures, weather, and seasons was studied. The time and frequencies of determining N₂-fixing activity of *Azolla* and a formula for calculating N₂-fixing activity are reported in this paper.

MATERIALS AND METHODS

Six species of *Azolla* were used for this experiment: *Azolla imbricata* (collected from China), *A. filiculoides* (GDR), *A. microphylla* (Ecuador), *A. caroliniana* (USA), *A. nilotica* (Sudan), and *A. mexicana* (USA). The composition of N₂-free nutrient solution and cultural methods followed were those of Li Zhuo-xin et al (6). The *Azolla* mat used for determining N₂-fixing activity should be kept at a uniform density, i.e., a thin layer of *Azolla* floating on solution.

The assay chamber for the acetylene-reduction determination was a 7.6-cm ID and 12-cm-tall glass serum bottle with the bottom removed so it would rest on the bottom of the pot. At the beginning of each assay, a space of 100 cm³ remained above the solution (the chamber ports were closed with serum stoppers) and 0.1 atm acetylene was injected into the chamber after which 1 cm³ gas samples were extracted from the chamber in 10 min. Gas samples were stored in 1-cm³ injectors, the tips of which were sealed with a plastic cement. Samples of 0.1 to 0.2 cm³ were analyzed with a 104 type gas chromatograph made in Shanghai, China. The *Azolla* remained in situ, within floating plastic rings in the pots, to be used in next determination.

RESULTS AND DISCUSSION

Nitrogenase activity

The results obtained in 1 mo indicated that the *Azolla* growing in a natural environment fixed atmospheric N all day and its nitrogenase activity varied with environment. The relation between N₂-fixing activity of *Azolla* and light, temperature, and weather are shown in Figure 1. In a 24-h period there was a regular variation. N₂ fixation rose rapidly after sunrise and fell at sunset.

Nitrogenase activity was lower on rainy days than on overcast days. It was highest on sunny days (Fig. 1). The activity on cloudy day was marked by peaks. N₂-fixing activity was inhibited when the light intensity and the temperature were below the limit for suitable growth of *Azolla* (Fig. ab).

Nitrogenase activity was highest in autumn, and successively lower in spring, summer, and winter. Figure 2 shows that nitrogenase activity of *A. filiculoides* was highest during winter and spring, those of *A. imbricata* and *A. microphylla* were highest during summer. This was because *A. filiculoides* is cold tolerant.

The optimum period for N₂ fixation of *Azolla* was between 1000 and 1400 h in spring, autumn, and winter; and from 0900 to 1000 h in the summer of

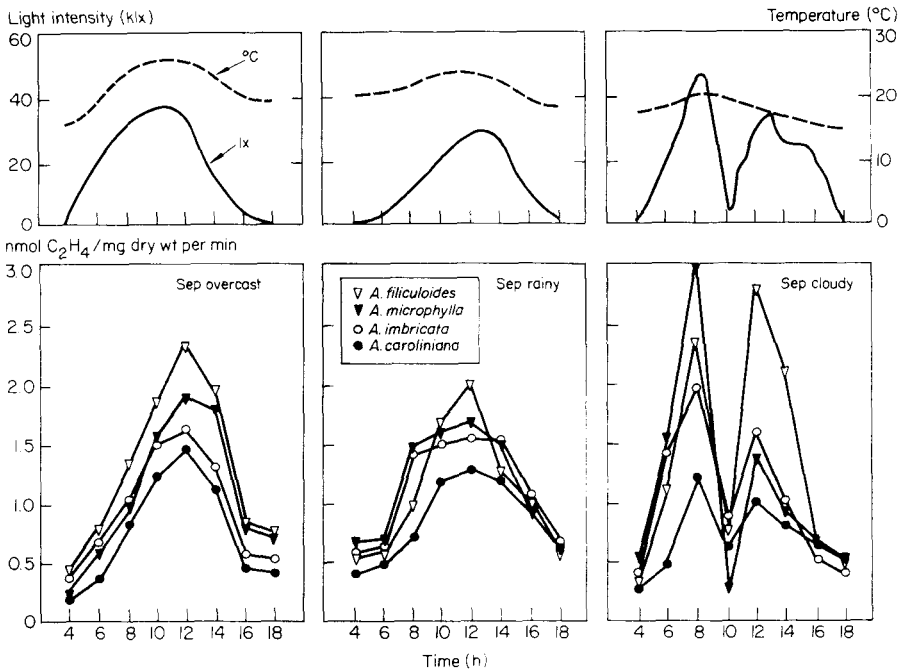

1. Relation between N₂-fixing activity of *Azolla* and light and temperature under different weather conditions.

clear days. The N₂-fixing activity of *Azolla* determined at any point of a day could not be referred to as nitrogenase activity for the whole day, nor could the actual amount of N₂ fixation be calculated from the N₂-fixing activity during those time periods.

Effect of light intensity and temperature on nitrogenase activity

Temperature played a decisive role in the growth and propagation of *Azolla*, but nitrogenase activity was influenced by light intensity. Nitrogenase activity variation of *Azolla* was similar to that of its photosynthesis.

All species of *Azolla* had an optimum natural light intensity range of 48-62 klx (Fig. 2b, c). The optimum light intensity and temperature for N₂-fixing activity differed only slightly by season for all species of *Azolla*. The light intensity and temperature required by cold-tolerant *Azolla* were slightly lower in spring and autumn than in other seasons, the reverse of these required by heat-tolerant *Azolla*. For example, the nitrogenase activity of cold-tolerant *A. filiculoides* was higher at 1200 h in spring and at 1000 h in summer and autumn, when light intensity ranged from 48 to 50 klx and temperature ranged from 23 to 28°C. Nitrogenase activity of heat-tolerant species such as *A. imbricata* and *A. microphylla* was highest between 1200 and 1400 h in spring, at 1000 h in summer, and at 1400 h in autumn. During these seasons light intensity was in the optimum range of 60-62 klx and optimum temperature

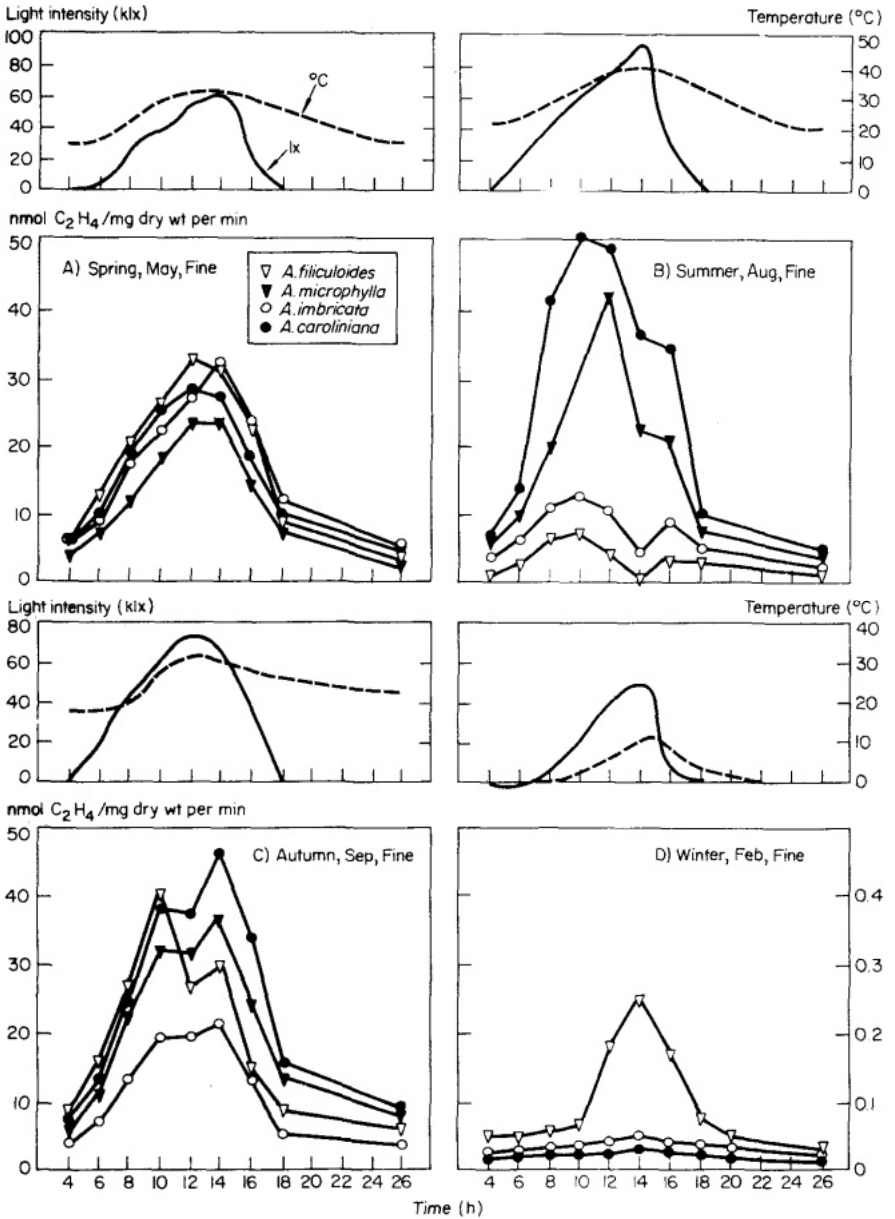

2. Relation between light, temperature, and N_2 -fixing activity of different *Azolla* sp. in different seasons.

ranged from 25 to 30°C. In fact the light intensity and temperature were suitable for most *Azolla* species. In the different seasons, nitrogenase activity differed greatly between the same and different *Azolla* species despite the same light intensities and temperatures.

Because the *Azolla* was in the environment of any season for a long time and its metabolism changed, its response to light and temperature differed. For instance, because, *A. filiculoides* grew well in the relatively suitable climate of spring or autumn throughout a season, its nitrogenase activity reached 33.37-40.23 nmol C₂H₄/min per mg dry wt (Fig. 2a, c at 1200 and 1000 h). But in summer, the strong sunlight and high temperature were unfavorable for growth and nitrogenase activity dropped to a value of only 0.75 nmol/min per mg dry wt, although it may have been slightly higher in more suitable light and temperature for short periods.

Nitrogenase activity among *Azolla* species differed although the determination was made in the seasons suitable for their growth. Figures 1 and 2 show that the N₂-fixing activity of *A. caroliniana* was not too sensitive to light and temperature, so the variation of activity is not large, but the highest N₂-fixing activity for the other *Azolla* could be twice as high as that of *A. caroliniana* in suitable conditions.

Attention should be paid to the light saturation point of N₂-fixing activity of *Azolla*. For example, the N₂-fixing activity of *A. filiculoides* stopped temporarily when light intensity reached 100 klx and temperature reached 39°C, which was below the lethal temperature to *Azolla*. Its N₂-fixing activity recovered, however, at 1600 h when the light intensity declined gradually to normal, but the temperature remained unchanged (Fig. 2b at 1400 h). The phenomenon of *A. rubra* (collected from Tokyo, Japan) was also present (6). Under artificial light, the light saturation point of photosynthesis varied with environment, such as 6-14 klx (11) and 20-40 klx (13). Our results indicate that the light saturation point for photosynthesis might be similar to that of N₂ fixation (48-62 klx) because the *Azolla* cultured under natural light grew well.

Determining and calculating the amount of N₂ fixed by *Azolla*

Because the N₂-fixing activity of *Azolla* varies with environment, a direct method for determining the amount of N₂ fixed by *Azolla*, which does not disturb the original environment, is necessary. First, a series of successive measurements was made by this direct method.

The amount of N₂ fixed by *Azolla* in unit weight and unit time was calculated by the following formula:

$$N = \frac{n}{a} Y K \frac{1}{wt} \quad (\text{Eq. 1})$$

where: n = mole C₂H₂, a = C₂H₄:N₂, (here = 3), Y = the peak height ratio of C₂H₂, K = the ratio of N_{C₂H₄}/N_{C₂H₂} to H_{C₂H₄}/H_{C₂H₂}, w = *Azolla* wt, and t = reaction time.

Second, the amount of N₂ fixed by *Azolla* was calculated from the results of successive determination. Recently, some reports have indicated that the values of N₂ fixed by *Azolla* obtained from Equation 1 were not consistent with those obtained by Kjeldahl's method or by the ¹⁵N method. Becking (3)

and Peters et al (9) reported the ratio a of C_2H_4 to $N_2 \neq 3$. Hence, we determined the reaction time of acetylene reduction, the value K , the ratio of $N_{C_2H_4} \cdot N_{C_2H_2}^{-1}$ (content ratio) to $H_{C_2H_4} \cdot H_{C_2H_2}^{-1}$ (peak height ratio) and the value a .

The reaction time of nitrogenase reducing acetylene was reported to take 30-90 min in some references, but took only 10 min by our method (Fig. 3), with the temperature and moisture inside and outside the reaction bottle nearly the same. Nitrogenase activity decreased if reaction time was increased, especially under strong sunlight. At 1200 h on a summer day, the temperature and moisture inside the reaction bottle were much higher than outside the bottle so that objective fact could not be demonstrated.

Generally, the value K is believed to be constant, but measurements by the internal standard method indicated it is a function. The curves of content ratio to peak height ratio were linear only within 30 nmol (Fig. 4). However, the contents of C_2H_4 exceeded 30 nmol in the actual determination, so the value K must be listed beforehand, according to the ratio of peaks height of samples. A proper value for K is selected to calculate exactly the N_2 -fixing activity of *Azolla*.

The value a (ratio of amount of C_2H_4 , to N_2) measured by the direct method every 2 h for 3 consecutive days and nights showed that $a = 3$, in conformity with the results obtained from Kjeldahl's method. The standard variance of a was only ± 0.16 (Table 1, 2). Twelve measurements during a day and night were too many. From many measurements, it was known that the N_2 -fixing activity of *Azolla* varied regularly throughout the day regardless of season or weather. Generally, the N_2 -fixing activity increased gradually from

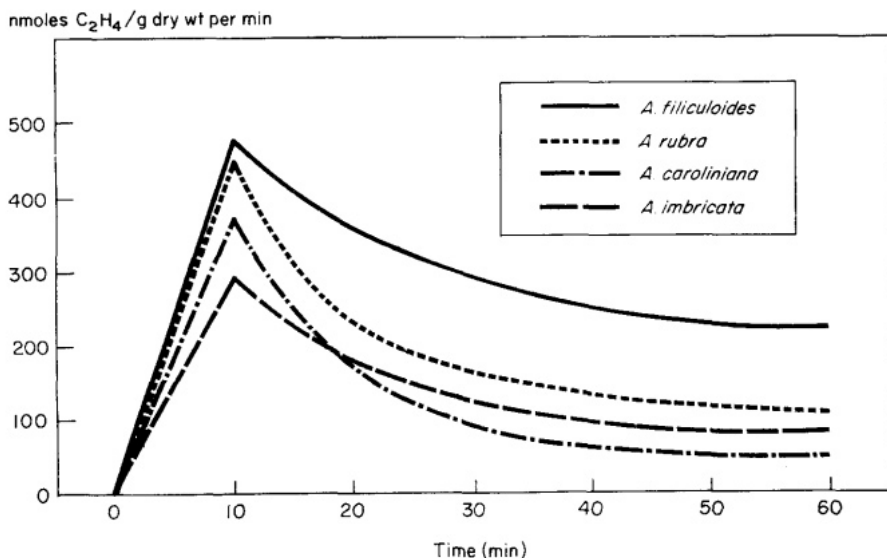

3. Effect of C_2H_2 reduction time on N_2 -fixing activity of different species of *Azolla*.

daybreak to 1000 h or so and decreased sharply from 1400 to 1800 h, declining slowly throughout the night. Hence, few measurements are required during the night, and a decrease in the number of daytime measurement is also possible.

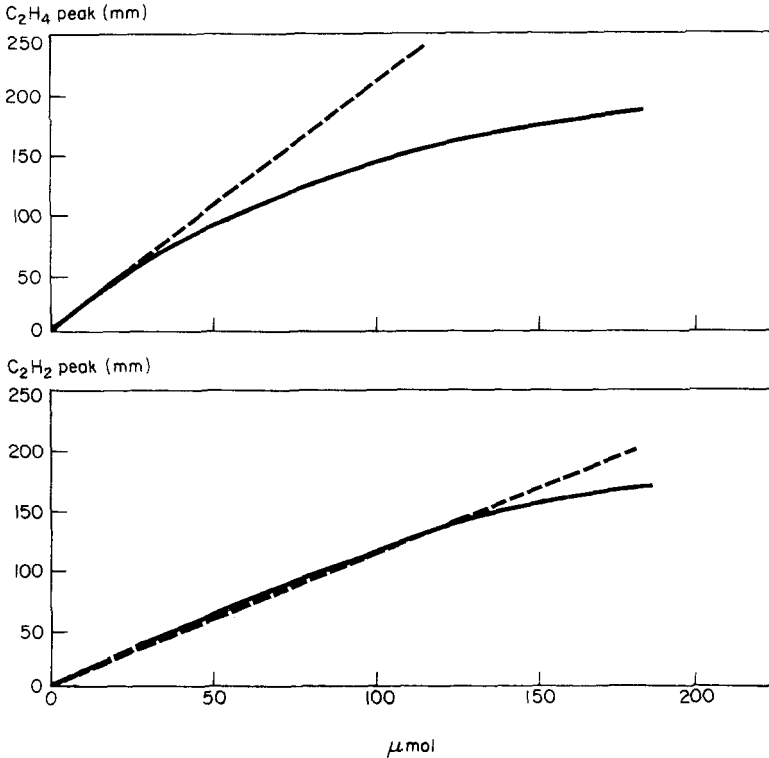

4. Peaks of C₂H₄ and C₂H₂ vs their amounts.

Table 1. Determination of a (ratio of C₂H₄ to N₂).

<i>Azolla</i> species ^a	Kjeldahl's method ^b		Acetylene reduction method ^c		Value of a
	nmol N/mg dry wt per day	mg N/g dry wt per day	nmol C ₂ H ₄ /mg dry wt per day	mg N/g dry wt per day	
<i>A. nilotica</i>	430	12.04	1271	11.85	2.96
<i>A. microphylla</i>	591	16.52	1845	17.27	3.12
<i>A. caroliniana</i>	561	15.68	1596	14.93	2.85
<i>A. mexicana</i>	575	15.96	1723	16.05	3.00
<i>A. imbricata</i>	711	19.88	2319	21.65	3.26
<i>A. filiculoides</i>	770	21.56	2200	20.53	2.86
$\bar{x} \pm SD$	606 ± 121	16.94 ± 3.37	1325 ± 388	17.05 ± 3.63	3.01 ± 0.16

^a There were 4 replications for each species. ^b Assayed after 3 d cultivation. ^c Sum of measurements tested 36 times at 2-h intervals.

Table 2. N₂ fixation measured by different methods.^a

mg N/g dry wt per day	mg N/g dry wt per day		Correlation coefficient
	Measured 12 times a day ^b	Measured 4 times a day ^c	
18.48±2.68	18.68±2.48	18.60±2.40	<i>r</i> = 0.962**

^a No. of replications = 16. ^b Method as described in Table 1. ^c Av of four measurements (at 0600, 1000, 1400, and 1800 h). The calculation was based on the formula

$$w_2 = \frac{4(b+c) + 8(a+d)}{3} \times 28 \times 10^{-3}$$

Table 3. Comparison of N₂ fixation measured at different intervals under different weather conditions.^a

Weather	C ₂ H ₂ reduction activity (nmol C ₂ H ₄ /mg dry Wt per day)		Amount of N ₂ fixation (mg N ₂ /g dry wt per day)		Correlation coefficient
	Measured 12 times a day	Measured 4 times a day	Measured 12 times a day	Measured 4 times a day	
Fine	2089 ± 342	2160 ± 432	19.51 ± 3.18	20.16 ± 3.32	<i>r</i> = 0.975**
Overcast	1325 ± 248	1299 ± 261	12.41 ± 2.30	12.13 ± 2.48	<i>r</i> = 0.971**
Rainy	1260 ± 310	1295 ± 365	11.76 ± 2.87	12.13 ± 3.40	<i>r</i> = 0.984**

^a 24 replications for each treatment.

Measurement data indicated that the total N₂-fixing activity of *Azolla* during 24 h was equal to the sum of the total average value obtained from 0600 to 1000, from 1000 to 1400, from 1400 to 1800, and from 1800 to 0600, multiplied by each time interval.

The calculation formula is as follows:

$$W_1 = \frac{(a+b)t}{2} + \frac{(b+c)t}{2} + \frac{(c+d)t}{2} + \frac{(d+a)t'}{2} \dots (1) \quad (\text{Eq. 2})$$

where: a, b, c, and d = the N₂-fixing activity of *Azolla* determined at 0600, 1000, 1400, and 1800 h, respectively; t = 4 h, t' = 12 h, and W₁ = total N₂-fixing activity of *Azolla* during 24 h.

Equation 2 can be simplified as follows:

$$W_1 = 4(b+c) + 8(a+d) \cdot (\text{nmol C}_2\text{H}_4/\text{mg dry wt per day}) \quad (\text{Eq. 3})$$

The formula for the total amount of N₂ fixed by *Azolla* during 24 h is:

$$W = \frac{4(b+c) + 8(a+d)}{3} \cdot 28 \cdot 10^{-3} \text{ mg N/g dry wt per day} \quad (\text{Eq. 4})$$

Its result is in conformity with the results obtained from Kjeldahl's method and from measurements in intervals of every 2 h.

Equation 4 can be divided into two parts, 2(a+b) + 4(b+c) and 6(a+d). The first expression is the N₂-fixing activity of *Azolla* in daytime and the second is its N₂-fixing activity during the night. The formulas are accurate for

any weather (Table 3). In spring or autumn, *Azolla* doubling time is 3 d. If weather remains fairly constant over some time, the actual amount of N₂ fixed by *Azolla* equals the amount of N₂ fixation obtained from the formulas and multiplied by its weight increase during the period.

REFERENCES CITED

1. Ashton, P. H., and R. D. Walmsky. 1976. The aquatic fern *Azolla* and its *Anabaena* symbiont. *Endeavour* 35(124):39-43.
2. Bai, K., S. Yu, and D. Shi. 1979. A simple method for the in situ nitrogen fixation measurement of *Azolla imbricata* [in Chinese]. *Acta Bot. Sin.* 21(2):197-198.
3. Becking, J. H. 1979. Environmental requirements of *Azolla* for use in tropical rice production. Pages 345-373 in *Nitrogen and Rice*. International Rice Research Institute, P.O. Box 933, Manila, Philippines.
4. Hill, D. J. 1977. The role of *Anabaena* in the *Azolla-Anabaena* symbiosis. *New Phytol.* 78(3):611-616.
5. Li, Z. 1982. Nitrogen fixation by *Azolla* in ricefields and its utilization in China. Pages 82-95 in *Transaction of the 12th international congress of soil science. Symposia paper I*.
6. Li, Z., S. Zu, M. Mao, and T. A. Lumpkin. 1982. Study on the utilization of 8 *Azolla* species in agriculture. I. An investigation of their utilization properties [in Chinese, English summary]. *Sci. Agric. Sin.* 1:19-27.
7. Mao, M., Z. Li, S. Zu, F. Wang, and B. Zhao. 1982. Study on some technical problems of measuring N₂-ase activity of *Azolla* by acetylene reduction method [in Chinese]. *J. Zhe-jiang Agric. Sci.* 2:99-103.
8. Peters, G. A., and B. C. Mayne. 1977. The *Azolla, Anabaena Azolla* relationship. II. Localization of nitrogen activity as assayed by acetylene reduction. *Plant Physiol.* 53(6):820-824.
9. Peters, G. A., B. C. Mayne, T. B. Ray, and R. E. Toia, Jr. 1978. Physiology and biochemistry of the *Azolla-Anabaena* symbiosis. Pages 325-344 in *Nitrogen and rice*. International Rice Research Institute, P.O. Box 933, Manila, Philippines.
10. Shi, D. 1981. Studies on photosynthetic characters of *Azolla* [in Chinese, English summary]. *Acta Phytophysiol. Sin.* 7(2):113-120.
11. Shi, D., J. Li, Z. Zhao, F. Wang, L. Zhu, and G. A. Peters. 1981. Studies on nitrogen fixation and photosynthesis in *Azolla imbricata* (Roxb) and *Azolla filiculoides* Lam. [in Chinese, English summary]. *Acta Bot. Sin.* 23(4):306-315.
12. Wen, Y., and J. Tang. 1978. A measure of nitrogen fixation activity of *Azolla imbricata* by acetylene reduction [in Chinese, English summary]. *Acta. Bot. Sin.* 20(3):273-275.
13. Zhang, Z., and C. Liang. 1981. A study on biological characteristics of *Azolla* in Yin Ma Zhuang [in Chinese]. *J. Shandong Agric. College* 1:1-8.

Use of ^{15}N in N_2 fixation and N cycling studies of *Azolla*

D.L. ESKEW

International Atomic Energy Agency

IAEA/FAO Joint Project, Vienna, Austria

The stable isotope of N, ^{15}N , has been used for many purposes in *Azolla* research. In physiological studies ^{15}N has been used to demonstrate excretion of fixed N by the *Anabaena azollae* endosymbiont and its utilization of the *Azolla* macrosymbiont. Reported conversion ratios of $\text{C}_2\text{H}_2:\text{N}_2$ reduction measured using $^{15}\text{N}_2$ vary from 1.7:1 to 7.9:1. Attempts have been made to adapt the ^{15}N isotope dilution technique to measure N_2 fixation by *Azolla* in rice floodwater. Preliminary indications are that 80% or more of *Azolla* N is derived from N_2 fixation. Pot and field studies using ^{15}N -labeled *Azolla* indicated that 20-30% of *Azolla* N was taken up by the first rice crop, and N recovery from *Azolla* and urea were similar in field studies. A time course study using ^{15}N , however, revealed that the patterns of N uptake by rice from *Azolla* and urea were different. Uptake of urea-N occurred primarily within 30 d of application, whereas the major uptake of *Azolla* N occurred between 30 and 60 d. Future studies using ^{15}N should concentrate on developing management practices that optimize the use of *Azolla* N by rice.

The stable isotope of nitrogen, ^{15}N , has found several applications in studies of N_2 fixation and N cycling by the *Azolla-Anabaena* symbiosis. These can be divided into 4 main areas: 1) studies of the biochemistry and physiology of the symbiosis, 2) determination of acetylene reduction to N_2 fixation conversion ratios, 3) measurement of N_2 fixation by the ^{15}N isotope dilution method, and 4) tracing the mineralization of the N contained in the *Azolla* biomass and its uptake by rice.

PHYSIOLOGY AND BIOCHEMISTRY

By isolating packets of the *Anabaena* symbiont after enzymatic digestion of the *A. caroliniana* Willd. leaves and exposing the isolated algae to $^{15}\text{N}_2$, it was possible to demonstrate that up to 50% of the ^{15}N assimilated by the *Anabaena* endosymbiont was excreted into the medium as NH_4^+ (12). However, only low levels of NH_4^+ could be found in the intact *Azolla-Anabaena* symbiosis, and ^{15}N was rapidly incorporated into ethanol insoluble fractions (14). These

results, coupled with data on the distribution of glutamine synthetase and glutamate dehydrogenase activities between the symbionts, indicate that much of the N fixed by the *Anabaena* endosymbiont is used by the *Azolla* macrosymbiont for its growth (17).

Kaplan and Peters (7) employed $^{15}\text{N}_2$ to study the distribution of fixation activity in relation to leaf development. Uptake of $^{15}\text{N}_2$ and acetylene reduction activity were very low in the apical region where no heterocysts were observed, increased rapidly with leaf maturity, and declined in senescent regions. Pulse-chase studies demonstrated that $^{15}\text{N}_2$ fixed in mature leaves containing endophytes with differentiated heterocysts was rapidly translocated to stem apices. Enrichment of the apex doubled within 60 min after the end of a 30-min $^{15}\text{N}_2$ exposure. Liu and Chen (9) used $^{15}\text{N}_2$ exposures to study NH_4^- excretion by intact *Azolla imbricata* Roxb. They found that 4-21% of the $^{15}\text{N}_2$ fixed could be excreted into the media in 3 d.

ACETYLENE REDUCTION: N_2 FIXATION CONVERSION RATIOS

The reported $\text{C}_2\text{H}_2:\text{N}_2$ conversion values range from 1.7:1 to 7.9:1, and vary between species (6), with N_2 partial pressure (16), with the duration of the assay (2), and with age of the culture [(21), (Table 1)]. It is obvious that a single, universal factor for converting C_2H_2 reduction activity to N_2 fixed cannot be used under all conditions. Probably the most valid conversion factor will be obtained using a pN_2 approximating that of air and with all other

Table 1. Summary of $\text{C}_2\text{H}_2:\text{N}_2$ conversion ratios reported in the literature for *Azolla*.

Ratio ^a $\text{C}_2\text{H}_2:\text{N}_2$	Assay conditions			Species	Reference
	Duration (h)	p N_2 (atm)	Age (d) ^b of <i>Azolla</i> culture		
3.2:1	5	0.3	nr	<i>A. caroliniana</i>	(16)
2.0:1	5	0.6	nr	<i>A. caroliniana</i>	(16)
1.7:1	5	0.8	nr	<i>A. caroliniana</i>	(16)
2.77:1	0.5	0.8	nr	<i>A. caroliniana</i>	(15)
3.38:1	1	0.8	nr	<i>A. caroliniana</i>	(15)
2.4:1	12	0.14	nr	<i>A. filiculoides</i>	(6)
6.0:1	12	0.14	nr	<i>A. caroliniana</i>	(6)
5.6:1	1	0.1	nr	<i>A. pinnata</i>	(2)
6.3:1	2	0.1	nr	<i>A. pinnata</i>	(2)
7.9:1	3	0.1	nr	<i>A. pinnata</i>	(2)
7.7:1	4	0.1	nr	<i>A. pinnata</i>	(2)
3.4:1 ^c	24	0.8	14	<i>A. pinnata</i>	(21)
1.6:1	24	0.8	19	<i>A. pinnata</i>	(21)
2.4:1	24	0.8	22	<i>A. pinnata</i>	(21)

^a Acetylene reduction assays were conducted under identical conditions using a $\text{p C}_2\text{H}_2$ of 0.1-0.15 atm. ^b nr = not reported. ^c N_2 fixation was measured by increase in total N per g fresh weight. In all other cases, $^{15}\text{N}_2$ incorporation was measured.

factors, including incubation time, as close to the same for both $^{15}\text{N}_2$ and C_2H_2 exposures as possible (16). Exposure period should be kept as short as possible. If a $^{15}\text{N}_2$ enrichment of more than 20% is used, a 1-h exposure should produce a measurable ^{15}N enrichment.

MEASURING N_2 FIXATION BY ^{15}N ISOTOPE DILUTION

Although the *Azolla-Anabaena* symbiosis grows rapidly in N-free nutrient solution, it has been shown that *Azolla* does have the ability to assimilate N from NO_3^- , NH_4^- , or urea (13). Thus, because *Azolla* often has been considered as a weed, it is desirable to establish what fraction of the N accumulated by *Azolla* in the field is derived from N_2 fixation, and what fraction from the soil and floodwater would represent competition with the rice crop. The ^{15}N isotope dilution method has been used extensively to measure the percentage of N derived from the atmosphere (% Ndfa) by leguminous crops (4,23). A few attempts have been made to adapt this technique for use with *Azolla*, but no thoroughly convincing results are available yet.

Ideally the ^{15}N isotope dilution technique is performed by growing a non- N_2 -fixing control plant and testing the N_2 -fixing symbiosis in a medium that is uniformly enriched with ^{15}N with regard to both space and time. If no N_2 is fixed from the atmosphere, then an additional source of N is available for the fixing plant, which would result in a dilution of its ^{15}N enrichment. The % Ndfa is then calculated by the equation (4):

$$\% \text{ Ndfa} = 1 - \frac{\%^{15}\text{N atom excess fixing plant}}{\%^{15}\text{N atom excess nonfixing plant}} \times 10$$

Several problems with the application of this technique to measure the % Ndfa for *Azolla* have not been overcome. Witty (23) developed a computer model which indicated that large errors in measuring N_2 fixation by legumes using the ^{15}N isotope dilution technique could occur if the ^{15}N enrichment of plant available N in the soil dropped rapidly. The greatest errors would occur when the time pattern of N uptake by the N_2 -fixing legume and control plant differed significantly. It has been reported that N added to the floodwater as $(\text{NH}_4)_2\text{SO}_4$ or urea is lost from the floodwater within 3-9 d (3,18). This results in a rapid change in the ^{15}N enrichment of the floodwater over time. Any method that results in a more uniform ^{15}N enrichment in the floodwater over time would reduce this source of error. Potential methods are to make several sequential additions of ^{15}N -labeled fertilizer, to mix a highly enriched fertilizer into the soil and wait for it to equilibrate with the soil N pool, or to use ^{15}N -labeled organic matter or another slow release form of N.

Watanabe and Talukdar (pers. comm.) mixed 1.48 g N/m² as $(\text{NH}_4)_2\text{SO}_4$ at 17.8% ^{15}N atom excess into 15 cm of soil in concrete tanks of 1 m² surface area, and allowed it to stand for 1 mo. They then grew 3 cycles of *A. pinnata* R.

Brown and *Lemna minor* L. in the next 143 d. Both plants were sufficiently labeled with ^{15}N to allow calculation of % Ndfa. In the first and third cycles, *Lemna* growth was very poor and the N contained in the inoculum was a significant fraction of the total N harvested. Attempts to correct for dilution of ^{15}N by the inoculum N gave anomalous results. Only in the second cycle, when *Azolla* and *Lemna* were grown together with rice, was N accumulation by *Lemna* adequate to overcome the effect of inoculum N. In this case % Ndfa for *Azolla* was estimated to be 85%.

Kumarasinghe (unpublished results) used both *Lemna minor* and *Salvinia auriculata* L. as control plants to estimate % Ndfa for *A. caroliniana*. Calculations based on either control gave 80% Ndfa. In this experiment, however, a single addition of ^{15}N -labeled urea was made at the beginning of a 28-d period, and growth of both controls was poor, thus the results can only be considered preliminary.

Care must also be taken that the amount of N added does not inhibit N_2 fixation. Peters et al (13) reported that *A. caroliniana* grown in nutrient solutions containing 35 ppm N as NO_3^- , NH_4^+ , or urea derived 86%, 70%, or 69% of its N content from the atmosphere. Thus, N_2 fixation by the *Azolla*-*Anabaena* symbiosis is relatively resistant to repression by combined N, and this should not be a major problem in the use of the isotope dilution technique. N concentrations in the floodwater of unfertilized ricefields have been reported to be 1 ppm or less (3) and our observations have given similar results. Thus, in the field it seems likely that most of the *Azolla* N is indeed derived from N_2 fixation.

MINERALIZATION AND N UPTAKE BY RICE

Results of the INSFFER (5) trials have indicated that rice yield increases from incorporating 20 t of *Azolla* fresh wt/ha plus 30 kg N/ha as urea were equivalent to those from 60 kg N/ha as urea. Talley and Rains (19) found that 40 kg N/ha incorporated as dried *A. filiculoides* Lam. produced a rice yield increase equivalent to an equal amount of N as ammonium sulfate, but incorporating 93 kg N/ha as dry *A. filiculoides* was only 70% as effective as ammonium sulfate. These results suggest that *Azolla* is roughly equivalent to chemical N fertilizers on a per kg N basis. These experiments, however, do not reveal how much of the N added was actually taken up by the rice, and it is possible that *Azolla* incorporation has other effects on rice growth besides supplying N.

Use of ^{15}N -labeled *Azolla* can provide this information, and allow the fate of N added to the system as *Azolla* to be traced. Watanabe et al (20), using ^{15}N , found that 26–28% of *Azolla* N was recovered by rice when dried *Azolla* was incorporated 30 or 53 d after transplanting (DT) but only 14% was recovered when incorporated 78 DT. A lower recovery, 13–15%, was observed 30 or 53 DT when *Azolla* was placed on the surface.

Mian (11) has conducted an extensive series of pot studies using ^{15}N - labeled *A. caroliniana*. He found that 19% of *Azolla* N incorporated was recovered in 60 d by rice plants as compared to 61% recovery of N from ammonium sulfate. Of the *Azolla* N not recovered in rice, 7% was unaccounted for and was presumed to be lost by denitrification, and 74% remained in the soil in a form that could not be extracted as NH_4^+ . Without rice plants, 93-96% of the N which was mineralized was lost by denitrification in 60 d. In the studies of Mian (11) and Watanabe et al (20) *Azolla* was dried and ground before incorporation. Kumarasinghe et al (8) found that N availability to rice from dried *Azolla* was 36% less than from fresh material. Thus, although it is easier to apply a stated amount of N using dried *Azolla*, N availability to rice may be underestimated.

In a field experiment, Kumarasinghe et al (8) found that 32% of 144 kg N/ha added as *A. caroliniana* was recovered in the aboveground biomass of rice, in comparison to 26% of 100 kg N/ha added as urea. The difference was not statistically significant. The *Azolla* used in this study had been frozen for storage. Kumarasinghe et al (8) found that freezing *Azolla* also reduced N availability by 30%.

Using ^{15}N it is also possible to follow the time course of N uptake (Table 2). The *Azolla* used in these studies had also been frozen before incorporation. Comparison of the N percentage derived from fertilizer and fertilizer N recovery at 3 harvest dates showed that the major uptake of urea N occurred within 30 d after incorporation, but the major uptake of *Azolla* N occurred between 30 and 60 d. This suggests that combining the two sources may be beneficial for rice production. These results, however, were obtained under temperate climatic conditions and results may differ under tropical conditions with higher soil temperatures.

Table 2. Time course of N uptake by rice from *Azolla* or urea incorporated into the soil.^a

Harvest DAF	Dry matter yield (kg/ha)	Total N yield (kg/ha)	N derived from fertilizer (%)	Fertilizer N recovery (%)
<i>Azolla 96 kg N/ha</i>				
30	196 ± 56	6.6 ± 1.8	48 ± 4	4 ± 1
60	2835 ± 384	43.2 ± 4.7	40 ± 2	18 ± 2
125	8500 ± 1100	75.0 ± 8.4	27 ± 3	21 ± 4
<i>Urea 60 kg N/ha</i>				
30	365 ± 83	11.7 ± 2.7	59 ± 3	12 ± 3
60	2629 ± 518	33.6 ± 6.8	31 ± 1	17 ± 3
125	6700 ± 1100	60.4 ± 7.9	13 ± 2	14 ± 4

^aThe experiment was conducted at the Research Institute for Irrigation, Szarvas, Hungary. The soil was ameliorated Meadow Solonetz Clay, pH 7.5. *Azolla caroliniana* was labeled with ^{15}N in nutrient solution as previously described (8). Both *Azolla* and urea fertilizers were placed in 5-cm-deep furrows between rice rows and covered with soil on 8 Jun 1984. Plot size was 1 m². Intermediate harvests were at 30 and 60 d after fertilizer application and the harvest at 125 d was at grain maturity. Values are means ± SE (n=4).

FUTURE USES OF ^{15}N

Based on available results it is reasonable to assume that 80% or more of the *Azolla* N is derived from the atmosphere. A few carefully conducted ^{15}N dilution experiments, however, are needed to substantiate this observation.

The major benefit to be gained from ^{15}N studies is developing practices which optimize the availability of *Azolla* N to rice. Experiments examining the interaction of chemical fertilizer N sources and *Azolla* N are needed.

Studies by Baillonville et al (1) have shown that digestibility of *A. filiculoides* by sheep declined from 77% during exponential growth to 49% at later stages. This was correlated with an increase in lignin from 3% to 24%. Lumpkin et al (1982) found that *A. pinnata* gave the greatest rice yield increases, although a selection of *A. filiculoides* had accumulated more N. They speculated that this may have been due to different rates of decomposition related to chemical composition. The use of ^{15}N -labeled *Azolla* should be very beneficial for evaluating the effect of culture age and chemical composition on N availability to rice.

ACKNOWLEDGMENTS

The collaboration of Ms. G. Kovacs and Dr. J. Dombovari of the Research Institute for Irrigation, Szarvas, Hungary, and the assistance of Mr. J.L. Arrillaga on the time course study are gratefully acknowledged.

REFERENCES CITED

1. Baillonville, T.D.W., P. Godard, and C. Van Hove. 1984. Chemical composition of *Azolla* populations as affected by ageing. Arch. Int. Physiol. Biochim. 92:30.
2. Becking, J.H. 1985. Nitrogen fixation by the *Azolla-Anabaena azollae* symbiosis. Pages 9-20 in The role of isotopes in studies on nitrogen fixation and nitrogen cycling by blue-green algae and the *Azolla-Anabaena* association. IAEA-TECDOC 325, Vienna.
3. Cao, Z.H., S.K. De Datta, and I.R.P. Fillery. 1984. Effect of placement methods on floodwater properties and recovery of applied nitrogen (^{15}N -labelled urea) in wetland rice. Soil Sci. Soc. Am. J. 48:196-208.
4. Fried, M., and V. Middelboe. 1977. Measurement of amount of nitrogen fixed by a legume crop. Plant Soil 47:713-715.
5. International Rice Research Institute. 1983. Revised report on the fourth trial on *Azolla* use in rice, INSFFER (1982). P.O. Box 933, Manila, Philippines.
6. Jones, K. 1985. The use of ^{15}N -labelled dinitrogen in the study of nitrogen fixation by blue-green algae. Pages 63-80 in The role of isotopes in studies on nitrogen fixation and nitrogen cycling by blue-green algae and the *Azolla-Anabaena* association. IAEA-TECDOC 325, Vienna.
7. Kaplan, D., and G.A. Peters. 1981. The *Azolla-Anabaena azollae* relationship. X. $^{15}\text{N}_2$ fixation and transport in main stem axes. New Phytol. 89:337-346.
8. Kumarasinghe, K.S., F. Zapata, G. Kovacs, D.L. Eskea, and S.K.A. Danso. 1985. Evaluation of the availability of *Azolla* N and urea N to rice using ^{15}N . Submitted to Plant Soil.
9. Liu, Z.Z., B.H. Chen, and W. Song. 1980. Preliminary studies on process of nitrogen excretion by *Azolla*. Pages 363-368 in Proceedings of the symposium on paddy soils, Nanjing.

10. Lumpkin, T.A., Z.Z. Li, S.X. Zu, and M.F. Mao. 1982. The effect of species of *Azolla* under three management practices on the yield of paddy rice. Pages 549-553 in Biological nitrogen fixation technology for tropical agriculture. P.H. Graham and S.C. Harris, eds. Centro Internacional de Agricultura Tropical, Cali, Colombia.
11. Mian, M.H. 1981. Biofertilizer and rice production — a ^{15}N tracer study. Ph D thesis, University of Dundee, Scotland, United Kingdom.
12. Peters, G.A. 1977. The *Azolla-Anabaena azollae* symbiosis. Pages 231-258 in Genetic engineering for nitrogen fixation. A. Hollaender, ed. Plenum Press, New York.
13. Peters, G.A., o. Ito, V.V.S. Tyagi, and D. Kaplan. 1981. Physiological studies on N_2 -fixing *Azolla*. Pages 343-362 in Genetic engineering of symbiotic nitrogen fixation and conservation of fixed nitrogen. J.M. Lyons, R.C. Valentine, D.A. Phillips, D.W. Rains, and R.C. Huffaker, eds. Plenum Press, New York.
14. Peters, G.A., B.C. Mayne, T.B. Ray, and R.E. Toia, Jr. 1979. Physiology and biochemistry of the *Azolla-Anabaena* symbiosis. Pages 325-344 in Nitrogen and rice. International Rice Research Institute, P.O. Box 933, Manila, Philippines.
15. Peters, G.A., T.B. Ray, B.C. Mayne, and R.E. Toia, Jr. 1980. *Azolla-Anabaena* association: morphological and physiological studies. Pages 293-309 in Nitrogen fixation. Vol. 11. W.E. Newton and W.H. Orme-Johnson, eds. University Park Press, Baltimore, Maryland, USA.
16. Peters, G.A., R.E. Toia Jr., and S.M. Lough. 1977. The *Azolla-Anabaena azollae* relationship. V. $^{15}\text{N}_2$ fixation, acetylene reduction, and H_2 production. Plant Physiol. 59:1021-1025.
17. Ray, T.B., G.A., Peters, R.E. Toia Jr., and B.C. Mayne. 1978. *Azolla-Anabaena* relationship. VII. Distribution of ammonia-assimilating enzymes, protein and chlorophyll between host and symbiont. Plant Physiol. 62:463-467.
18. Simpson, J.R., J.R. Freney, R. Wetselaar, W.A. Muirhead, R. Leuning, and O.T. Denmead. 1984. Transformations and losses of urea nitrogen after application to flooded rice. Aust. J. Agric. Res. 35:189-200.
19. Talky, S.N., and D.W. Rains. 1980. *Azolla filiculoides* Lam. as a fallow-season green manure for rice in a temperate climate. Agron. J. 72:11-18.
20. Watanabe, I., K.Z. Bai, N.S. Berja, C.R. Espinas, O. Ito, and B.P.R. Subudhi. 1981. The *Azolla-Anabaena* complex and its use in rice culture. IRRI Res. Pap. Ser. 69. 11 p.
21. Watanabe, I., C.R. Espinas, N.S. Berja, and B.V. Alimagno. 1977. Utilization of the *Azolla-Anabaena* complex as a nitrogen fertilizer for rice. IRRI Res. Pap. Ser. 11. 15 p.
22. Watanabe, I., and P.A. Roger. 1985. Use of ^{15}N in the study of biological nitrogen fixation in paddy soils at the International Rice Research Institute. Pages 81-98 in The role of isotopes in studies on nitrogen fixation and nitrogen cycling by blue-green algae and the *Azolla-Anabaena* association. IAEA-TECDOC 325, Vienna,
23. Witty, J.F. 1983. Estimating N_2 fixation in the field using ^{15}N -labelled fertilizer: some problems and solutions. Soil Biol. Biochem. 15:631-639.

DISCUSSION

LADHA: How do you rule out the possibility that N_2 fixed by *Azolla* is released or excreted and taken up by *Lemna* or *Salvinia*? In the experiment where you showed 80% N derived from fixation and 24 kg N was fixed, in how many days were these attained?

ESKEW: In the first experiment, this possibility cannot be eliminated, although the evidence for excretion is limited. In the second experiment, control fixing plants were grown in separate plots, thus, any NH_4^+ excreted by *Azolla* would not be available to the control *Salvinia*. The 24 kg N was fixed in 26 d.

Decomposition of *Azolla* in the field and availability of *Azolla* nitrogen to plants

WEN QI-XIAO, CHENG LI-LI, AND SHI SHU-LIAN

Nanjing Institute of Soil Science

Academia Sinica

Nanjing, China

A 5-yr decomposition experiment and a 2-yr microplot experiment using nonlabeled and ^{15}N -labeled *Azolla* and milk vetch were conducted to determine the decomposition rate, the composition of the humified products, and the fate of the N of these plant materials. *Azolla* decomposed significantly slower than milk vetch. After 5 yr about 36-39% of the added *Azolla* C remained in the soil under waterlogged conditions, and 21-22% under upland conditions. The mean annual decomposition rate of *Azolla* was estimated at 0.022-0.0267/yr for the resistant pool with a half-life of 26-37 yr under waterlogged conditions, and 0.0300-0.0467/yr with a half-life of 15-23 yr under upland conditions. The mineralization pattern of N was similar to that of C. Under waterlogged conditions, considerable amounts of the C and N derived from *Azolla* and retained in the soil were found in the light fraction. Fifty-four percent of the C and 43% of the N were retained after 6 mo; after 1 yr 42% of the C and 37% of the N were retained. Results of the microplot experiment were consistent with those of the decomposition experiment. The contribution of *Azolla* to supplying N for the current crop and in building soil N reserves is discussed.

About 450 kg of atmospheric N/ha can be fixed by *Azolla* annually (8). Efficient use of *Azolla* requires a knowledge of its pattern of decomposition and transformation as they affect the current and subsequent crops.

While the positive effects of *Azolla* on rice yield and soil physical properties are well demonstrated, the underlying reactions of *Azolla* in soil are not as well known. Some short-term experiments have been reported, but very few data exist on the fate of residual C and N. This paper describes a decomposition experiment using nonlabeled *Azolla* and milk vetch applied to two soils. The release of C and N from these organic materials over 5 yr was determined. The data were compared with a microplot experiment using ^{15}N -labeled *Azolla* and ^{15}N -labeled milk vetch.

MATERIALS AND METHODS

Materials

Nonlabeled *Azolla* and milk vetch were used in the decomposition experiment. ^{15}N -labeled *Azolla* (N 5.01%, 11.21% ^{15}N abundance) and ^{15}N -labeled milk vetch (N 4.40%, 19.61% ^{15}N abundance) were used in the microplot field experiment.

Two soils were used in the decomposition experiment: a Xiashu loess containing 0.09% C and 0.032% N (including 239 ppm fixed $\text{NH}_4\text{-N}$), and a Quaternary red clay containing 0.12% C and 0.034% N (including 138 ppm fixed $\text{NH}_4\text{-N}$).

The microplot field experiment was conducted in Wuxi County, Jiangsu Province, on a bleached paddy soil. The surface soil contained 1.17% C and 0.112% N at the beginning of the experiment in May 1981.

Decomposition experiment

The experiment was conducted in the field. The procedures followed were similar to those of Lin et al (6). An 8-g sample of plant material was added to each 100 g of soil, thoroughly mixed, and transferred into a carborundum tube. The tubes were fitted with covers that were fixed with rubberized fabric. Half of the samples were buried in the surface layer of a paddy field, and the other half were buried in an upland field. At intervals of 3, 6, 12, 36, and 60 mo after the experiment began, 3 tubes of each treatment were removed, air dried and ground to pass through a 60-mesh screen for analysis and densimetric fractionation.

Microplot field experiment

The microplot experiment was conducted in a paddy field where the 2-yr rotation was early rice - late rice - barley - single rice - wheat. The microplots were made by embedding a set of 20-cm diam plastic cylinders into soil to a depth of 25 cm, so that 10 cm remained above the soil surface. The plow layer (0-15 cm) was removed from each cylinder and replaced by an equivalent quantity of thoroughly mixed soil from an adjacent area to ensure uniformity of the surface soil of all microplots. In the organic manure treatments, ^{15}N -labeled *Azolla* or milk vetch containing 467 mg N/microplot was thoroughly mixed with the soil before it was transferred into the cylinder. Three 22-day-old rice seedlings were transplanted in each cylinder after flooding the soil. All treatments except the check were replicated three times; the check was replicated four times. Throughout the experiment the same crop was grown in the cylinders as in the neighboring field to provide a buffer area. Late rice, barley, single rice, and wheat were grown successively from August 1981 to May 1983 without fertilizer N.

At each harvest, the mature crops were removed and grain and straw were separated. The 0-15 cm soil layer was quantitatively removed. A small representative soil sample was taken after the roots were removed as

completely as possible by hand. Soils from different microplots of each treatment were then combined, mixed thoroughly with additional P and K fertilizers, and transferred into the cylinder for cultivating the succeeding crop. To the microplot from which the soil sample was taken, an equal volume of finely powdered clean quartz was added to keep the soil level in the cylinder the same as that of the outside.

In May 1983 the immature wheat plants, which had stopped growing due to N starvation, were harvested and the cylinders removed. After root removal, the soil was air dried and subsamples were taken in the usual manner.

Soil samples for analysis were dried and ground to pass through 60-mesh screen. Grain, straw, and roots were dried at 60°C, weighed, and ground in a mill using a 0.25-mm sieve.

Incubation experiment

Each 10-g soil sample was transferred into 120 x 15 mm tube. Enough water was added to the tube to maintain a water depth of about 1 cm. Samples were incubated at 30°C in the dark for 4 wk, and then the ammonium mineralized was determined.

Densimetric fractionation

Portions of Ture solution ($\text{HgI}_2 + \text{KI}$), specific gravity 1.8, were added to centrifuge tubes containing soil samples and vibrated in a mechanical shaker for 1 h. The soil sample was thus fractionated into a light fraction (specific gravity <1.8) and a heavy fraction (specific gravity >1.8) by centrifuge. Both fractions were washed with KI and alcohol, dried, and ground to pass through a 60-mesh screen for analysis.

Chemical determination

Organic C was determined by Turin's method, total N of both soils and organic materials by the Kjeldahl method, and exchangeable and fixed ammonium by Bremner's method (2, 13).

Isotope ratio was determined on a ZHT-01 mass spectrometer. Nitrogen was released by reaction with alkaline hypobromite.

Carbohydrates were first extracted by 24N H_2SO_4 at room temperature for 2 h and then by 1N H_2SO_4 at 100°C for 5 h. Hexoses were determined by the anthrone method (9) and pentoses by the acetate-aniline method (16).

Humic substances were extracted by 0.1M $\text{Na}_4\text{P}_2\text{O}_7$ -0.1N NaOH solution. Isolation of humic acid and determination of the optical density were done by the conventional method (3).

RESULTS

Decomposition rate in carborundum experiment

Azolla decomposes much more slowly than straw or leguminous green manure such as milk vetch, irrespective of the climatic conditions and soil type under

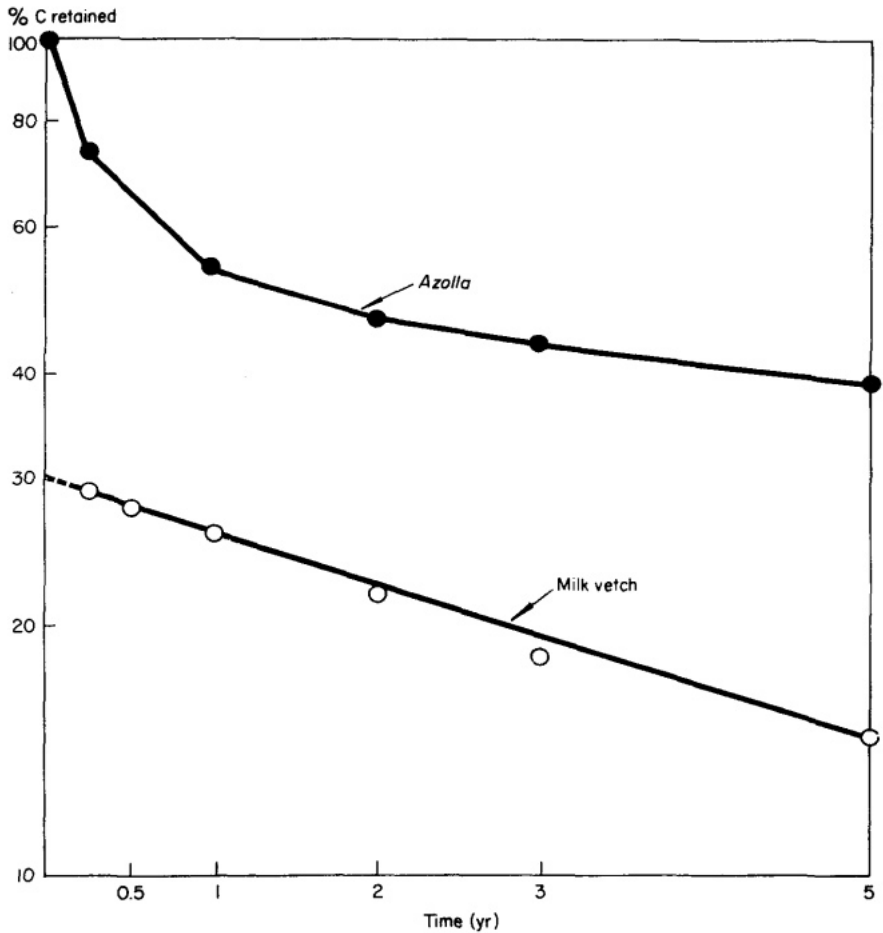

1. Decomposition of *Azolla* and milk vetch in Xiashu loess under waterlogged condition.

which it is decomposed (7). This held true in our experiment not only in the early stage of decomposition, but in the 3d - 5th year of the experiment. In the Xiashu loess under waterlogged conditions, about 46% of *Azolla* C was lost in the first year and only an additional 15% was mineralized in the last 4 yr. The corresponding values for milk vetch were 74 and 9% (Fig. 1). Under upland conditions, although the decomposition rate of *Azolla* was higher than that under waterlogged conditions, it was still less than that of milk vetch. About 78% of *Azolla* C was lost in 5 yr; the corresponding figure for milk vetch was about 88% (Fig. 2). In Quaternary red clay, the decomposition rate of *Azolla* was noticeably higher than that in the Xiashu loess under both waterlogged and upland conditions. It was still lower, however, than that of milk vetch (Figs. 3, 4).

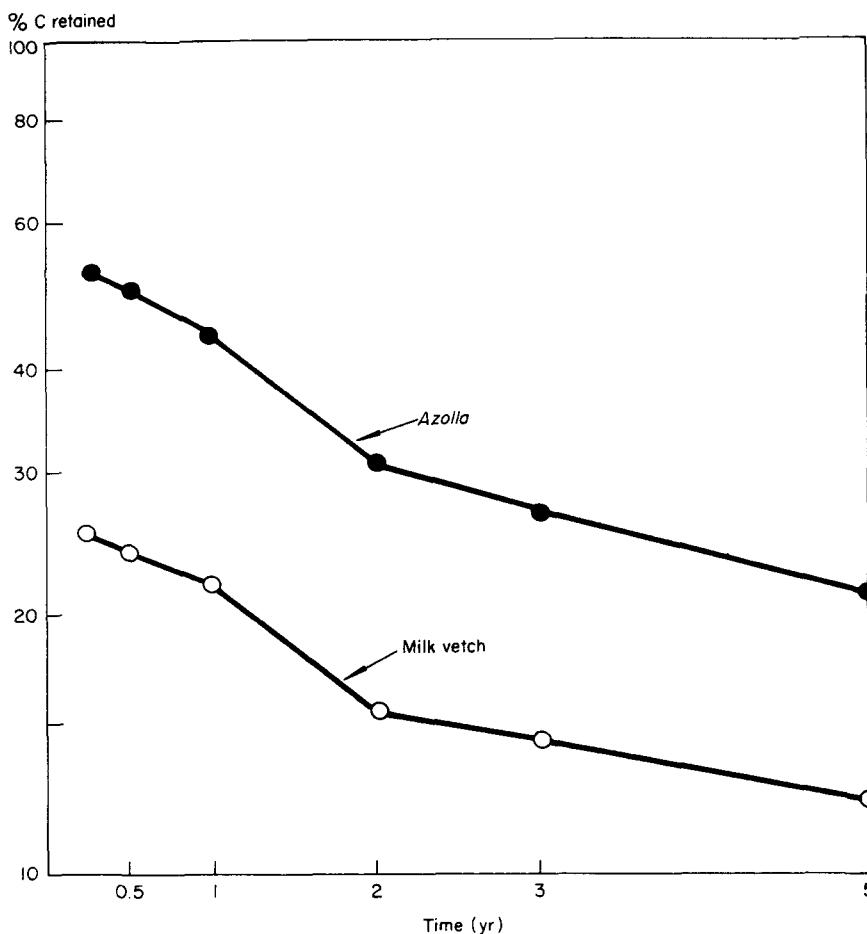

2. Decomposition of *Azolla* and milk vetch in Xiashu loess under upland condition.

Based on the assumption that the decomposition follows first-order kinetics, the rate constant of the resistant pool of *Azolla* under waterlogged conditions was 0.0267/yr with a half-life of 26 yr in Xiashu loess and 0.020/yr with a half-life of 35 yr in Quaternary red clay. The rate constant under upland conditions was 0.030/yr with a half-life of 23 yr in Xiashu loess and 0.0467/yr with a half-life of 15 yr in Quaternary red clay. Data of C loss of milk vetch at 0.25, 0.5, 1, 2, 3, and 5 yr in Xiashu loess under waterlogged conditions and those in Quaternary red clay under upland conditions fit well into a straight line relation ($R^2 = 0.9690$ and 0.9287), indicating that the labile pool of milk vetch was almost completely decomposed in the first 3 mo after the experiment began. The rate constant of the resistant pool of milk vetch evaluated from the slope of regression was 0.0303/yr in Xiashu loess and 0.0444/yr in Quaternary red clay.

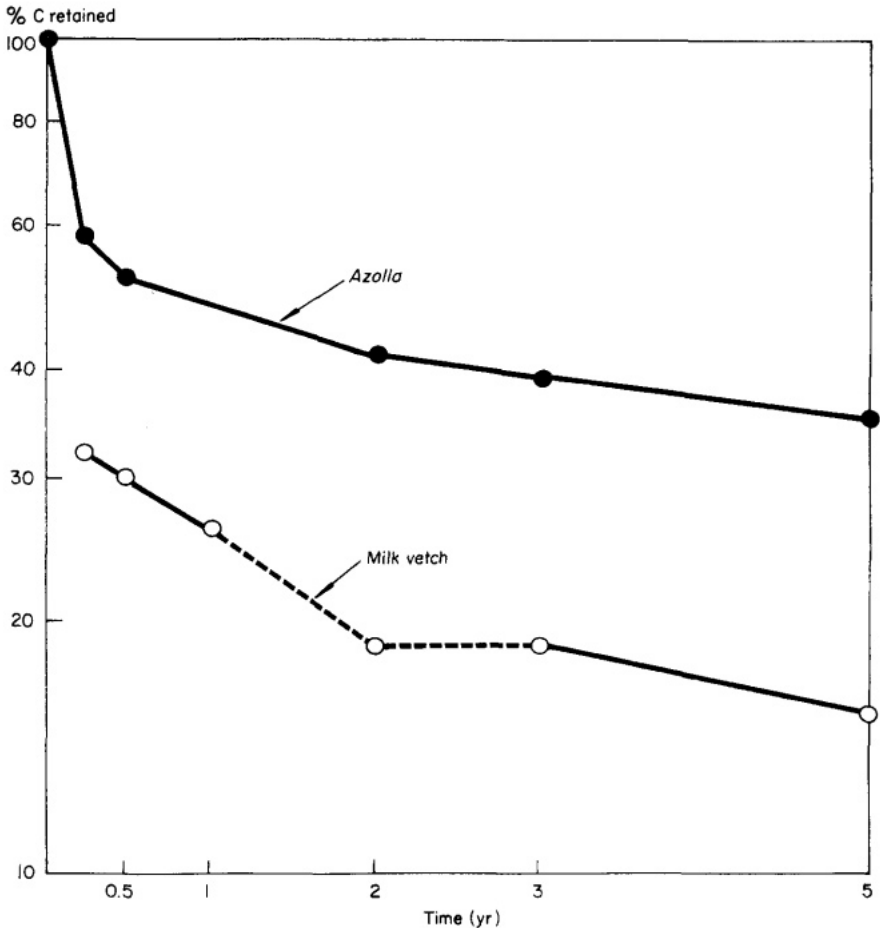

3. Decomposition of *Azolla* and milk vetch in Quaternary red clay under waterlogged condition.

Azolla decomposed slowly largely because of its high lignin content. This was evidenced by the fact that under waterlogged conditions, about 18% of *Azolla* C and N originally applied was found in the undecomposed or partially decomposed form after 2 yr, while about 2% of milk vetch C was present in the light fraction (Tables 1, 2). The fact that the rate constant of the resistant pool of *Azolla*, in which less than 5% of the C could be identified in the light fraction after 2 yr, was almost equal to that of milk vetch, strongly suggests that the humified products of *Azolla* were as resistant to biodegradation as that of milk vetch.

Mineralization of organic nitrogen

The amount of *Azolla* N and milk vetch N retained in the soils followed the pattern of C retention. However, on a percentage basis more N than C

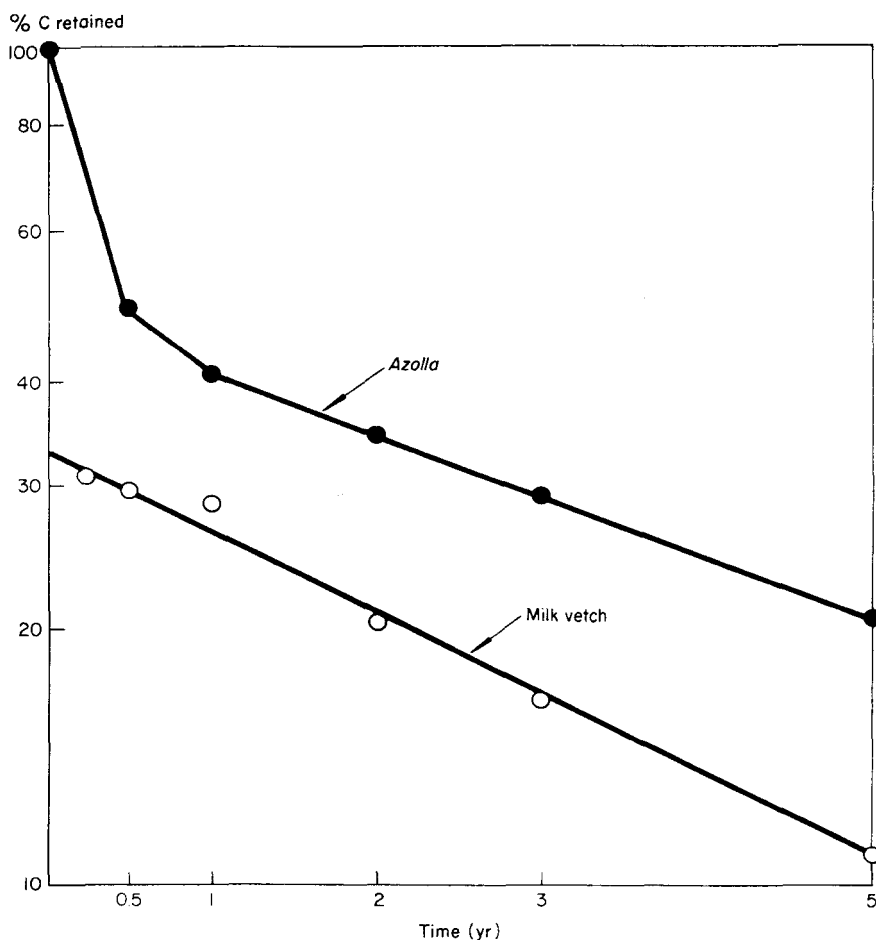

4. Decomposition of *Azolla* and milk vetch in Quaternary red clay under upland condition.

Table 1. Distribution of residual C in fractions. Xiashu loess.^a

Plant material	Duration of experiment (mo)	Under waterlogged condition			Under upland condition		
		LF	HF	Loss	LF	HF	Loss
<i>Azolla</i>	3	57.9	43.5	-1.4	23.3	71.1	5.7
	6	54.3	40.5	5.7	13.7	80.7	5.6
	12	41.5	49.1	9.4	10.7	80.9	8.4
	24	39.0	66.2	-5.3	2.4	96.5	1.2
	36	32.0	61.2	6.8	—	95.8	—
Milk vetch	3	15.2	63.4	21.4	3.5	87.2	9.3
	6	11.2	75.0	13.9	3.9	89.2	6.9
	12	9.1	82.8	8.1	1.0	87.8	11.1
	24	4.4	86.6	9.0	—	—	—
	36	2.1	91.6	6.3	—	—	—

^aLF = light fraction, HF = heavy fraction.

Table 2. Distribution of residual N in fractions, Xiashu loess.^a

Plant material	Duration of experiment (mo)	Under waterlogged condition			Under upland condition		
		LF	HF	Loss	LF	HF	Loss
Azolla	3	45.8	55.0	-0.8	18.0	80.6	1.4
	6	42.7	54.9	2.4	9.9	90.7	-0.6
	12	37.4	60.9	1.7	8.2	87.5	4.2
	24	n.d.	74.2	n.d.	1.7	97.6	0.7
Milk vetch	36	27.9	72.0	-1.9	n.d.	n.d.	-
	3	6.0	89.6	4.4	1.0	96.3	2.8
	6	3.3	95.3	1.4	1.1	97.7	1.2
	12	2.7	95.5	1.8	-	-	-
	24	1.3	90.5	8.2	-	-	-

^aLF = light fraction, HF = heavy fraction, n.d. = not determined,

Table 3. Mineralization of *Azolla* N under waterlogged condition.

Duration of experiment (mo)	Total N (ppm)	Fixed NH ₄ ⁺ (ppm)	Exch. NH ₄ ⁺ (ppm)	N mineralized (%)	Loss ^a (%)
Xiashu loess					
3	2850	544	145	33.1	18.7
6	2160	464	61	50.1	40.9
12	2100	425	35	49.9	42.8
24	1830	431	38	58.9	51.5
36	1920	400	24	54.5	48.6
60	1730	465	25	62.8	54.7
Quaternary red clay					
3	2120	320	108	52.2	42.9
6	1720	211	40	59.4	55.8
12	1940	190	26	51.2	48.7
24	1590	188	29	62.5	59.9
36	1510	178	21	64.5	62.5
60	1460	184	18	66.2	64.1

^aAmount of N lost (N_l) = N_m - (E_t - F_t). (For N_m, E_t, and F_t, see text).

remained in the soils. This was attributed to: 1) the presence of exchangeable and fixed ammonium in the soil, and 2) the difference in the nature of the plant materials and their humified products.

The N in plant materials mineralized during any given period during the 5-yr experiment was estimated as follows:

$$N_m = N_o - (N_t - E_t - F_t)$$

where n_m is the amount of plant material N mineralized from the beginning of the experiment to time t , and N_o is the amount of plant material N originally applied. N_t is the amount of N derived from plant material in the soil at time t , E_t is the increment of exchangeable ammonium in soil at time t , and F_t is the increment of fixed ammonium in soil at time t . The results obtained, expressed in percentage of N originally applied, are given in Tables 3 and 4. Much less *Azolla* N was mineralized in the Xiashu loess and in Quaternary red clay than milk vetch N, and the percentage of *Azolla* N mineralized in Xiashu loess was

Table 4. Mineralization of milk vetch-N under waterlogged condition.

Duration of experiment (mo)	Total N (ppm)	Fixed NH_4^+ (ppm)	Exch. NH_4^+ (ppm)	N mineralized (%)	Loss ^a (%)
Xiashu loess					
3	1640	693	96	69.7	48.1
6	1570	602	49	67.1	50.9
12	1430	552	32	68.9	56.4
24	1270	542	28	75.7	62.7
36	1240	527	25	76.1	63.8
60	1120	514	23	80.2	68.6
Quaternary red clay					
3	1440	387	131	71.8	56.9
6	1210	271	52	73.2	65.9
12	1040	185	17	75.1	72.6
24	895	192	22	81.3	78.3
36	878	178	18	81.2	79.0
60	821	176	12	84.0	82.0

^aAmount of N lost (N_l) = $N_m - (E_t - F_l)$ (For N_m , E_t , and F_l , see text).

Table 5. C and sugar content of the humified products of *Azolla* and milk vetch.

Duration of experiment (mo)	<i>Azolla</i>			Milk vetch		
	C	Hexoses	Sugar-C (%)	C	Hexoses	Sugar-C (%)
	organic N	pentoses	Total C	organic N	pentoses	Total C
3	4.5	—	—	8.4	—	—
6	4.4	—	—	8.7	—	—
12	4.9	2.34	9.2	9.6	1.73	15.2
24	7.1	2.92	6.7	10.4	1.44	10.4
36	5.7	2.32	4.8	9.6	2.05	9.3

lower than that in Quaternary red clay during the entire experiment, especially in the early stage of decomposition. No difference in the percentage of milk vetch N mineralized between the two soils could be observed.

Chemical characteristics of the humified products

The C:N ratio of the humified products was lower than that generally found in soils and in milk vetch. This was in accordance with its relatively low content of neutral sugars (Table 5). The hexoses:pentoses ratio of the humified product of *Azolla* was higher than those of milk vetch and rice straw. It is not clear whether this was induced by the difference in sugar composition between these plant materials.

The optical density (E_4) of the newly formed humic acid derived from *Azolla* was significantly higher than that derived from milk vetch, indicating that the aromaticity of the humic acid derived from *Azolla* was higher than that from milk vetch (Table 6). Presumably, this was because not only the products of deep destruction but also some larger fragments of lignin in the *Azolla* had taken part in the formation of humic acid.

Table 6. Fractional composition of humus derived from *Azolla* and milk vetch.

Duration of experiment (mo)	<i>Azolla</i>			Milk vetch		
	Extractability	HA/FA	E ₄	Extractability	HA/FA	E ₄
3	20.4	0.23	1.15	27.7	0.42	0.68
6	22.5	0.23	1.11	26.8	0.45	0.63
12	21.4	0.22	1.22	23.5	0.43	0.66
24	17.8	0.18	-	24.5	0.23	0.87
36	21.9	0.24	0.90	23.6	0.41	0.63

More humic acid was found in the humified product of *Azolla* that was decomposed under upland conditions than that under waterlogged conditions, and, judging from the E₄, the aromaticity of the humic acid formed under upland conditions was slightly lower than that formed under waterlogged conditions.

Nitrogen availability

Consistent with decomposition experiment results, the microplot experiment revealed that the availability of *Azolla* N was significantly lower than that of milk vetch N. Only about 20% of *Azolla* N was recovered by early rice and 74% remained in the soil, while the corresponding figures for milk vetch were about 42% and 46% (Table 7).

Although a relatively large amount of *Azolla* N remained in the soil at the end of the first cropping season, an insignificant amount of it could be taken up by succeeding crops. Table 8 shows that only about 4.8% of ¹⁵N-labeled *Azolla* N was recovered by the second crop, and an additional 2.5% was recovered by the third and fourth crops. In the ¹⁵N-labeled milk vetch experiment, about 7.7% N was taken up by the second crop and 3.6% was taken up by the third and fourth crops (Table 8).

The N availability ratio, the ratio of percentage of residual N mineralized to percentage of soil N mineralized, is generally used to characterize the availability of residual N of fertilizers. Figure 5 shows that the availability of residual N of milk vetch was about 3 times that of soil N at the end of the first cropping season and, as expected, decreased gradually over time, being 1.8 times that of soil N at the end of the fourth cropping season. The availability of residual *Azolla* N was equal to that of soil N at the end of the first cropping season, and decreased to about 0.5 that of soil N at the end of the fourth cropping season (Fig. 5).

The plant recovery of residual N by the fourth crop was somewhat higher than that by the third crop (Table 8), which seems to contradict the results given in Figure 5, which show that the availability of residual N decreased regularly with time. The fact is that the mineralization rate of organic N was greater under flooded conditions than under upland conditions, and the accumulated temperature in the single rice-growing season was much higher than that in the barley growing season.

Table 7. Balance sheet of N from field experiment using ^{15}N -labeled materials, % of ^{15}N applied.

Plant material ^a	Grain+straw	Roots	Soil	Loss
<i>Azolla</i>	19.23 ± 1.03	0.74 ± 0.03	73.72 ± 3.70	6.32 ± 4.36
Milk vetch	39.74 ± 1.45	1.85 ± 1.20	46.16 ± 2.03	12.26 ± 2.27

^a 466.8 mg N/microplot as labeled organic material.

Table 8. Recovery of residual N of ^{15}N -labeled organic materials by successive crops, % of N originally applied (microplot experiment). ^a

Plant material ^b	2d crop (Late rice)	3d crop (Barley)	4th crop (Single rice)
<i>Azolla</i>	4.84 (6.56)	0.77 (1.27)	1.78 (3.09)
Milk vetch	7.68 (16.64)	1.29 (3.54)	2.27 (6.76)

^a Figures in parentheses denote the plant recovery of organic manure-N expressed as the percentage of residual N in soil at the beginning of each cropping season. ^b 466.8 mg N/microplot as labeled organic material.

N availability ratio

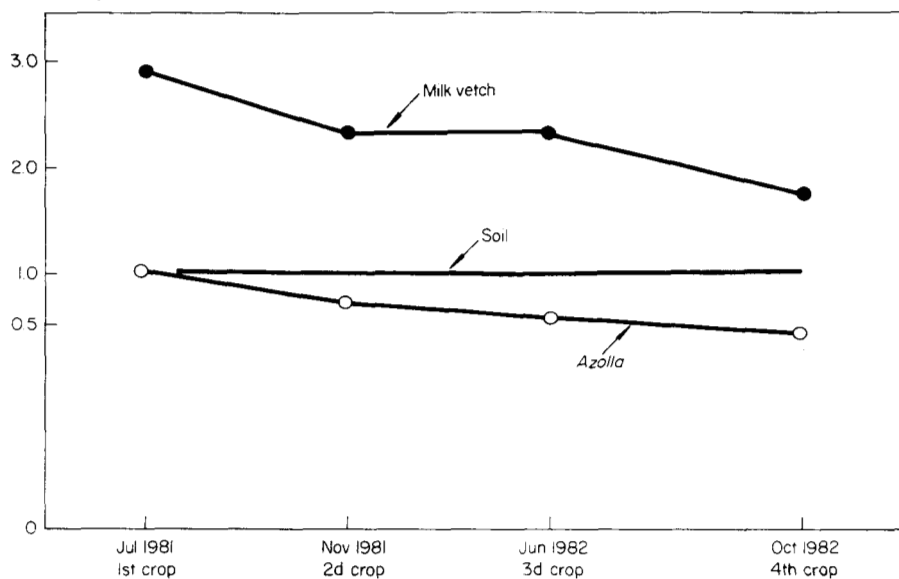

5. Change of availability of residual N.

CONCLUSION

The use of carborundum tubes in decomposition studies has many advantages. It eliminates the interference of plant roots. The mechanical removal of materials from the container or by soil fauna is prevented. The wall of the tube allows the microorganisms as well as water and air to pass freely, i.e., well-

controlled conditions are provided while the definition of a field experiment is not violated.

The possible drawback is that the decomposition rate may tend to slow as the participation of soil fauna in the decomposition process is excluded. Mineralization of organic N may also be affected by the absence of plant root activity (1).

The results of the decomposition experiment showed that lignin content profoundly affected the decomposition rate of plant materials, especially when decomposition proceeded under waterlogged conditions in which the activity of fungi and actinomycetes was restricted. Kononova and Alexandrova (4) found that the water-conducting xylem vessel walls of the cortex of timothy remained partly intact after the plant material had been allowed to decompose under aerobic conditions for 27 yr.

As a result of *Azolla's* relatively high lignin content, mineralization of organic N was restricted. Under waterlogged conditions, about 33% of the *Azolla* N originally applied was mineralized in 3 mo in the Xiashu loess, a figure about 50% of that of milk vetch N. Results from the microplot experiment also indicated that about 28% of *Azolla* K was mineralized in the first cropping season, while 58% of milk vetch N was mineralized. We agree with Shi et al (11, 12) who found that the availability of *Azolla* N to the rice plant was about 30-60% of that of milk vetch N.

Our results contradict incubation and greenhouse experiments conducted in the tropical region, which demonstrated that the availability of *Azolla* N was almost equal to that of ammonium sulfate; about 62-72% of the total N added was released in an incubation of 4-6 wk (10, 14, 15). Reasons for this discrepancy are not now known. It is unlikely that it can be accounted for by varietal differences of *Azolla* in chemical decomposition. Available data indicated that, although the chemical composition of *Azolla* varies widely by variety and by the season in which it is grown, lignin content never falls below 20% (5). Soil conditions affect decomposition greatly. However, it is not known whether this discrepancy was induced by the differences in soil conditions under which these experiments were conducted.

That the availability of residual N of organic materials was low and decreased over time is demonstrated. This has been well demonstrated in a greenhouse experiment (12), which also showed that even if the light fraction was considered, the N availability of newly formed humus derived from *Azolla* differed somewhat from that derived from milk vetch.

In our microplot experiment, the fifth crop in all the treatments suffered severely from N starvation. This does not imply that the residual N could not mineralize further. Rather it indicates that the amount of N released was too small to meet the needs of plant. Data presented in Table 5 indicated that even under waterlogged conditions, 63-66% of *Azolla* K was mineralized in 5 yr. It is evident that *Azolla*, although inferior to milk vetch as a N source for the current crop, may serve as a good resource for the buildup of soil N reserve. This is especially true when *Azolla* N is compared with chemical N fertilizer.

Taking priming effect as the result of biological interchanges, as much as 60% of the applied *Azolla* N was gained by the soil after the first cropping season, while the corresponding figure for ammonium sulfate was 8%.

REFERENCES CITED

1. Jenkinson, D.S. 1977. Studies on the decomposition of plant material in soil. The effects of plant cover and soil type on the loss of C from ^{14}C labelled ryegrass decomposing under field conditions. *J. Soil Sci.* 28:424-434.
2. Keeney, D.R., and J.M. Bremner. 1966. Determination and isotope ratio analysis of different forms of nitrogen in soils. 4. Exchangeable ammonium, nitrate, and nitrite by direct distillation methods. *Soil Sci. Soc. Am., Proc.* 30:583-594.
3. Kononova, M.M. 1961. *Soil organic matter*. Pergamon Press, Oxford, England.
4. Kononova, M.M., and E.V. Alexandrova. 1973. Formation of humic acids during plant residue humification and their nature. *Geoderma* 9 (3):157-164.
5. Li, Z., S. Zu, M. Mao, and T.A. Lumpkin. 1982. Study on the utilization of 8 *Azolla* species in agriculture. 1. An investigation of utilization properties [in Chinese]. *Sci. Agric. Sin.* 1:19-28.
6. Lin, X., L. Cheng, N. Xu, and Q. Wen. 1981. The application of carborundum tube for the determination of decomposition rate of plant residues under field conditions [in Chinese]. *Acta Pedol. Sin.* 18:98-102.
7. Lin, X., Q. Wen, and N. Xu. 1985. Field decomposition of plant residues in soils in Guangzhou district [in Chinese, with English summary]. *Acta Pedol. Sin.* (in press)
8. Liu, C. C. 1979. Use of *Azolla* in rice production in China. Pages 375-394 in *Nitrogen and rice*. International Rice Research Institute, P.O. Box 933, Manila, Philippines.
9. Morris, D.L. 1948. Determination of glucose by Anthrone method. *Science* 107:254-255.
10. Saha, K.C., B.C. Panigrahi, and P.K. Singh. 1982. Blue-green algae or nitrogen addition on the nitrogen and phosphorus availability and redox potential of a flooded rice soil. *Soil Biol. Biochem.* 14:23-26.
11. Shi, S., L. Cheng, X. Lin, C. Shu, and Q. Wen. 1978. Effect of *Azolla* on the fertility of paddy soils [in Chinese, with English summary]. *Acta Pedol. Sin.* 15:54-60.
12. Shi, S., X. Lin, and Q. Wen. 1981. Decomposition of plant materials in relation to their chemical composition in paddy soil. Pages 306-310 in *Proceedings symposium on paddy soil*. Science Press, Beijing.
13. Silva, J.A., and J.M. Bremner. 1966. Determination and isotope-ratio analysis of different forms of nitrogen in soils. 5. Fixed ammonium. *Soil Sci. Soc. Am., Proc.* 30:587-594.
14. Singh, P.K., B.C. Panigrahi, and K.B. Satapathy. 1981. Comparative efficiency of *Azolla*, blue-green algae and other organic manures in relation to N and P availability in flooded rice soil. *Plant Soil* 62:35-44.
15. Watanabe, I., C.R. Espinas, N.S. Berja, and B.V. Alimagno. 1977. Utilization of the *Azolla-anabaena* complex as a nitrogen fertilizer for rice, *IRRI Res. Pap. Ser.* 11 p.
16. Wen, C.H., and L.L. Chen. 1962. The determination of pentoses in soils with aniline [in Chinese, with English summary]. *Acta Pedol. Sin.* 10:220-226.

DISCUSSION

VAN HOVE: The *Azolla* species you used for your experiments is very rich in lignin, probably due to the species itself and population age. I would like to suggest comparison between that species and one poor in lignin such as *A. microphylla*, and comparison of the decomposition process at different population ages.

WEN QI-XIAO: The lignin content of all *Azolla* sp. in China is higher than 20%. I hope to obtain species with lignin content less than 20% for my work.

KANNAIYAN: Do you have any information on the micronutrient status of rice soil due to *Azolla* application?

WEN QI-XIAO: So, I have not.

ESKEW: Did you measure changes in cation exchange capacity, and could this explain long-term effects of *Azolla* better than N effects?

WEN QZ-XIAO: No. I do not think the cation exchange capacity of the soil will change greatly under our experimental conditions.

Studies on the promotion of nitrogen fixation and hydrogen evolution in *Azolla imbricata* by cast iron

LIANG ZHONG-JIN, CHENG SHUANG-GI,
AND MO HSI-MU

Department of Biology
South China Normal University
Guangzhou, China

Azolla imbricata cultivated in Ca superphosphate solution containing cast iron can endure high and low temperatures. *Azolla* grown in cast iron pots containing 0.03% (w/v) crude Ca superphosphate had higher yield and chlorophyll content, more grana lamellae in chloroplasts of fern, more photosynthetic lamellae in the symbiont *Anabaena azollae*, and higher C₂H₄ reduction and H₂ evolution rates than that cultivated in enamelware containing 0.03% Ca superphosphate and 5 mg/liter or 30 mg/liter ferric citrate. It is much easier to culture green algae such as *Oedogonium*, *Chaetonema*, and *Ulothrix* in the solution with ferric citrate as the Fe source than in the one with cast iron as Fe source. There is significantly more Fe and Mn in the leaves of *Azolla* cultivated in solution containing cast iron pieces. Cast iron, probably in the form of a chelate, provides *Azolla* with Fe and Mn constantly.

Under normal conditions in Guangzhou, *A. imbricata* cannot endure high or low temperature, which makes it difficult to utilize. During an investigation in the suburb of Guangzhou in December 1975, we found that most of the *Azolla* in the fields died at a temperature of 0°C. However, *A. imbricata* grew normally outdoors in a cast iron pot containing Ca superphosphate solution. Since then, we have cultivated and propagated *A. imbricata* in cast iron pots containing 0.03% crude superphosphate solution. The plants have grown well and exhibit dark green leaves and flourishing roots, regardless of temperature.

From 1981 to 1983, *A. imbricata* was cultivated in cast iron pots and other containers under natural conditions. The chemical composition of the culture media, and ultrastructure and physiological characteristics of *Azolla* grown in cast iron pots and other containers were compared to determine the causes of enhanced N₂ fixation and H₂ evolution in *Azolla*, and to provide a reference for the practical utilization of *A. imbricata*.

METHODS AND RESULTS

N₂ fixation and H₂ evolution of *A. imbricata* cultivated in cast iron pots in winter and summer

The experiments were conducted in January when it was overcast, rainy, and temperature ranged from 4 to 10 °C, and again in June-July when temperature was 30-41 °C. After 15 d culture in a cast iron pot containing tap water and crude Ca superphosphate (0.03% w/v), *Azolla* was incubated for 4 h outdoors under natural conditions. Temperature was 8-10°C and light intensity was 4.5-5 klx in January; temperature was 30-41 °C and light intensity was 60 klx in June-July. Then C₂H₂ reduction and H₂ evolution rates in *Azolla* were measured. Meanwhile, *Azolla* was cultivated indoors in glass pots containing modified IRRI N-free culture medium at temperatures of 23-25 °C, and light intensity of 10 klx for 15 d. After 15 d culture it was incubated for 4 h and C₂H₄ formation and H₂ evolution rates were measured. The N₂-fixing ability of *Azolla* cultivated outdoors in cast iron pots was 47% of that cultivated indoors in glass pots in January and 38% of that in June-July while H₂ evolution rates were 65% and 39% (Table 1).

It is clear that *Azolla* cultivated in cast iron pots containing Ca superphosphate can maintain a level of N₂ fixation and H₂ evolution under low light and low temperature in late winter or under high light and high temperature in summer in Guangzhou.

***A. imbricata* cultivated in cast iron pots or enamelware**

A. imbricata was cultivated in 1) cast iron pots containing 0.03% (w/v) crude Ca superphosphate; 2) enamelware containing 0.03% crude Ca superphosphate, 5 mg/liter ferric citrate and 0.0025 mg/liter molybdic acid; and 3) enamelware containing 0.03% crude Ca superphosphate and 5 mg/liter ferric citrate.

Azolla cultivated in cast iron pots had much richer photosynthetic lamellae and denser grana lamellae in the chloroplasts of the fern and richer lamellae in the vegetative cells of *Anabaena azollae* in the leaf cavity than that cultivated in enamelware (Figs. 1-4).

Table 1. Comparison of the ability of C₂H₂ reduction and H₂ evolution in *A. imbricata* cultivated for 15 d with ferric citrate indoors or with cast iron outdoors in winter or summer.

Cultivation group	Incubation conditions			C ₂ H ₂ reduction		H ₂ evolution	
	Light intensity (klx)	Temperature (°C)	Time (h)	nmol/g fresh wt	%	nmol/g fresh wt	%
I ^a	10	25	4	53.8 ± 8.7	100	4.6 ± 0.4	100
II ^b	4.5-5	8-10	4	25.1 ± 1.2	47	3.1 ± 0.4	65
III ^c	60	41	4	20.4 ± 2.3	38	1.8 ± 0.3	39

^aIndoors in glass pots containing modified IRRI N-free medium, 16 h light and 8 h darkness each day. ^bCast iron pots, natural conditions in winter. ^cCast iron pots, natural conditions in summer.



1. Thylakoid of chloroplast in leaf of *A. imbricata* cultivated in cast iron pot containing 0.03% calcium superphosphate. (X18000)



2. Thylakoid of chloroplast in leaf of *A. imbricata* cultivated in enamelware containing 0.3% calcium superphosphate + ferric citrate (5 mg/liter) (X20000).



3. Photosynthetic lamellae of *Anabaena azollae* in the leaf cavity of *A. imbricata* cultivated in cast iron pot containing 0.03% calcium superphosphate (X39000).



4. Photosynthetic lamellae of *Anabaena azollae* in leaf cavity of *A. imbricata* cultivated in enamelware containing 0.03% calcium superphosphate + ferric citrate (5 mg/liter) (X39000).

Table 2. Comparison of the yield of *A. imbricata* after cultivation outdoors in a cast iron pot and enamelware containing different culture solutions.

Group ^a	Inoculum (g fresh wt)	Total <i>Azolla</i> after 15 d (g fresh wt)	Increase (%)
I ^b	15	35.4	136
II ^c	15	26.6	77
III ^d	15	25.2	68

^a Av temperature 9 °C, range 3-15 °C; light intensity 4-5 klx. ^bCast iron pot containing P. ^cEnamelware containing P, Mo, and ferric citrate. ^dEnamelware containing P and ferric citrate.

Some algae such as *Oedogonium*, *Chaetonomia*, and *Ulothrix* appeared in the culture solution in enamelware, but not in cast iron pots.

The biomass is shown in Table 2; C₂H₂ reduction rates, H₂ evolution, and chlorophyll content of *A. imbricata* cultivated under different conditions are shown in Table 3 and in different media (Fig. 5).

***A. imbricata* cultivated in glass pots containing cast iron**

To avoid the physical effects on results caused by factors such as container shape, color, and light absorption, glass pots were used in the following experiments. *Azolla* was cultivated in solutions containing 1) Ca superphosphate and 30 mg/liter ferric citrate; or 2) Ca superphosphate and cast iron pot pieces. The dry weight, chlorophyll content, C₂H₄ formation rate, and H₂ evolution rate of *A. imbricata* in the group were 47, 64, 65, and 71%, respectively, of those in the second group. These results indicate cast iron pieces promote N₂ fixation and H₂ evolution in *Azolla*.

Some metal elements in the culture media and *Azolla*

Contents of Fe, Mn, and Mo in culture solutions of Ca superphosphate in cast iron pots and enamelware, and in the leaves of *A. imbricata* grown outdoors in the solutions for 15 d were measured. Table 4 indicates that there was more Fe and Mn both in the solution contained in the cast iron pots and leaf dry matter of *A. imbricata* cultivated in that solution.

DISCUSSION

Recently, some authors (3,4) reported that Fe deficits reduced the quantities of thylakoids in chloroplasts and contents of chlorophyll a, b, P700, and Cyt. f in flowering plants. Olsen (1970), after observing *Azolla* in the field, suggested that Fe and Mn play an important role in the growth of *Azolla*. Liu et al (1) considered that ferrous sulfate enhances the growth and N₂-fixing activity of *Azolla*. It is inferred that the promotion of growth of *A. imbricata* by cast iron results from the constant supply to *Azolla* of Fe, Mn, probably in chelate form, enhancing N₂ fixation and H₂ evolution. Its mechanism remains to be investigated.

Table 3. Comparison of C₂H₂ reduction, H₂ evolution, and chlorophyll content in *A. imbricata* cultured outdoors^a in cast pot or enamelware for 15d.

	Group	C ₂ H ₄ nmoles/g fresh wt min	Percentage of Group I	H ₂ nmoles/g fresh wt min	Percentage of Group I	Chlorophyll (mg/g fresh wt)	Percentage of Group I
I ^b	Cast iron pots P	26.5±2.7		5.1±0.5		0.236	
II ^c	Enamelware Fe-citrate P, Mo	13.8±4.1	52.1	2.4±0.5	47.1	0.62	68.6
III ^d	Enamelware Fe-citrate P	10.5 ± 1.7	39.6	2.0±1.0	39.2	0.144	61.0

^a Av temperature 9°C, range 3-15°C, light intensity 4-5 klx. ^b Cast iron pot containing P. ^c Enamelware containing P, Mo, and ferric citrate. ^d Enamelware containing P and ferric citrate.

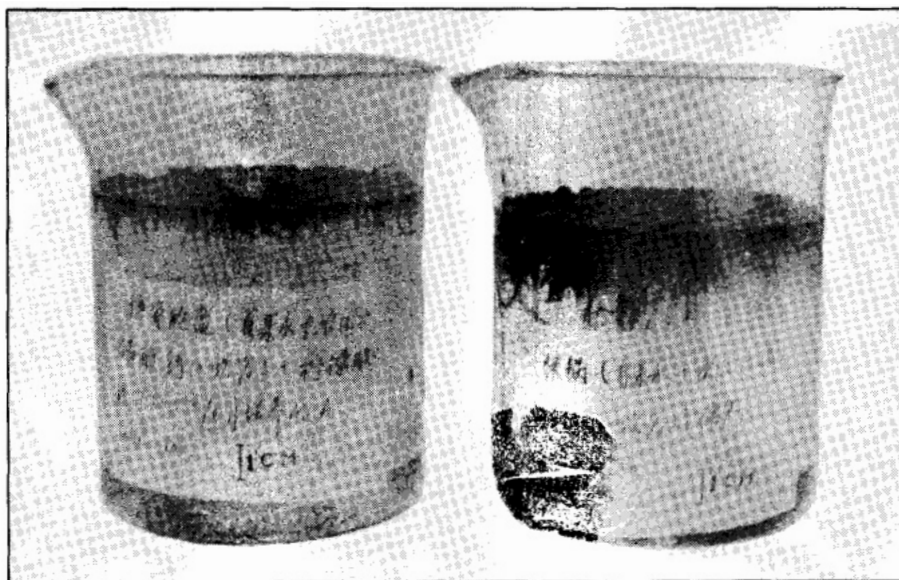

5. *A. imbricata* cultivated in cast iron pot (tap water + calcium superphosphate) (right), in enamelware (tap water + calcium superphosphate + 30 mg/liter ferric citrate) (left).

Table 4. The Fe, Mn, and Mo content of culture solutions of Ca superphosphate in cast iron pots and enamelware and in the leaves of *A. imbricata* inoculum cultured in the solutions for 15 d.

Element	Amount in solution (mg/liter)				Amount in leaves (mg/kg dry wt)	
	Cast iron pots ^a		Enamelware ^b		Cast iron pots	Enamelware
	Inoculum	No inoculum	Inoculum	No inoculum		
Fe	24.000	14.000	1.000	0.600	1850.00	260.00
Mn	0.990	0.800	0.230	0.020	470.00	110.00
Mo	0.019	0.005	0.019	0.005	0.08	0.08

^aCast iron analysis (%): Fe, 97.0000; Mn, 0.4000; Mo, 0.0025. ^bFerric citrate (5 mg/liter) added.

REFERENCES CITED

1. Liu, Chung-chu, C. Kang, T. G. Ren, and J.K. Lin. 1979. Preliminary study on some physiological aspects of *Azolla* [in Chinese, English summary]. *Chinese Agric. Sci.* (2):63-70.
2. Olsen, O. 1970. On biological nitrogen fixation in nature, particularly in blue-green algae. *C. R. Trav. Lab. Carlsberg* 37 (12): 269-283.
3. Peters, G.A. 1977. The *Azolla*-*Anabaena azollae* symbiosis. Pages 231-258 in *Genetic engineering for nitrogen fixation*. A. Hollaender et al, eds. Plenum Press, New York.
4. Scott, E.T., N. Terry, and R.P. Huston. 1982. Limiting factors in photosynthesis. III. Effects of iron nutrition on the activity of three regulatory enzymes of photosynthetic carbon metabolism. *Plant Physiol.* 55:626-631.
5. Spiller, S., and N. Terry. 1980. Limiting factors in photosynthesis. II. Iron stress diminishes photochemical capacity by reducing the number of photosynthetic units. *Plant Physiol.* 65: 121-125.

POSTER ABSTRACTS

AZOLLA IN THE PHILIPPINES

J.C. Bunoan, Jr., and C. Bersabe
Fertilizer Use and Promotion Section
Bureau of Soils
Ministry of Agriculture and Food (MAF)
Manila, Philippines

Azolla research was introduced in the Philippines through the International Rice Research Institute as early as 1975. Applied research on *Azolla* utilization in lowland rice was initiated by the Bureau of Soils in 1979. The National *Azolla* Action Program and the Unified *Azolla* Program were created to promote *Azolla* culture and utilization nationwide. They include basic and applied research components and training of MAF field personnel and rice farmers. The Philippine Government fully supports the dissemination of *Azolla* technology in its Masagana 99 rice production program, particularly in irrigated areas.

The high cost of imported mineral N and the resulting reluctance of farmers to apply chemical fertilizers has paved the way for *Azolla* N to supplement or substitute for mineral N in lowland rice. A regional propagation center to propagate adapted *Azolla* sp., previously screened at the National *Azolla* Center at the University of the Philippines at Los Baños, has been established in each of the 12 MAF regions of the country. *Azolla pinnata* Bangkok, *A. microphylla*, and *A. caroliniana* are the common adapted varieties propagated. Each regional propagation center distributes a minimum of 500 kg of *Azolla* inoculum to farmers each week. Early in 1985, 54 provincial, 767 municipal, and 4,267 community (barangay) nurseries of various pond sizes were established to meet the *Azolla* inoculum needs of farmers at no cost to them.

Current recommendations for lowland rice are to supply about 50% of the N requirement of the crop with *Azolla* sources. We recommend applying green-manure *Azolla* before transplanting, followed by a crop of *Azolla* soil-incorporated 20-30 d after transplanting. If possible, a third *Azolla* crop may be grown but not incorporated for soil improvement and for utilization by the succeeding rice crop. Fresh *Azolla*, fed in regulated amounts, is now a common feed for animals and freshwater fish. *Azolla* provides a low-cost, feasible, and acceptable technology for most Filipino farmers and animal and fish raisers.

Basic and applied research programs under the National *Azolla* Action Program are now directed more toward sporulation and hybridization studies for tolerance of constraints encountered in the Philippines. Isotope studies using ¹⁵N-labeled tracers to monitor *Azolla* N₂ fixation and utilization by the

rice plant are conducted with FAO, IAEA, and SIDA support. Continuous utilization studies of *Azolla* as an organic fertilizer (in wetland and upland conditions) and as an animal feed supplement are done without sacrificing high agricultural production.

As of January 1985, more than 2,700 field technicians and about 8,000 farmers had been trained in *Azolla* technology.

KIWANIS *AZOLLA* PROGRAM IN THE PHILIPPINES

Antonio C. Leviste
Chairman, Kiwanis National *Azolla* Program
Ayala Kiwanis, Republic of the Philippines

Kiwanis involvement in *Azolla* technology started in 1982, through the Philippine Luzon District, Kiwanis International. *Azolla* workshops have been conducted in many provinces and cities to assist in the transfer of technology of utilizing *Azolla* as a fertilizer and an animal feed.

The 12 Outstanding *Azolla* Farmers and the 1,000 *Azolla* Maintenance Nurseries are the projects that have gained popularity among farmers through the promotion of Ayala Kiwanis in the provinces. Extensive technical support has been given by the Unified *Azolla* Program of the Ministry of Agriculture and Food.

Based on proven methods and results, farmers are taught how to use *Azolla* as green manure in lowland rice production, including its nursery culture, multiplication, management, and utilization.

Farmers have also learned to increase their income through alternative uses of *Azolla* such as supplemental feed for poultry, swine, and fish. Others have gone into vegetable farming using *Azolla* for part of their organic compost.

The seven elements of the Kiwanis *Azolla* program are given below.

1. Education through workshops, farmer-level discussions, and news media.
2. Small, manageable *Azolla* maintenance nurseries with farmer-cooperators at the barrio level, making inexpensive *Azolla* inocula readily accessible to farmer propagator-end users.
3. Dissemination of information on new developments in *Azolla* technology and utilization to further increase farmers' income.

4. Monitoring the activities of *Azolla* nursery operators and farmer end users for the benefit of those engaged in agriculture as a whole.
5. Assisting farmers directly and indirectly in the marketing of their farm products, including fresh or dried *Azolla*.
6. Providing incentives for farmers and Kiwanis members supporting the program through continuing recognition of their participation.
7. Support of the Unified *Azolla* Program of the Ministry of Agriculture and Food in all technical phases.

EXPERIMENT REPORT OF DISCOVERY AND USE OF FANGSHAN COUNTY WILD *AZOLLA*

Wang Zai de and Wang Pu
Beijing Agricultural University
Beijing, China

In 1981 we discovered a wild species of *Azolla* in the streams and rice fields at Dong-gan-chi village in Fangshan County while we were engaged in extending the cultivation of *Azolla* in rice fields. We learned from local farmers that the wild *Azolla* strain had existed in the area for many years. Dong-gan-chi is located at 39° 38' N latitude. The water temperature in springs and streams is a constant 13-14 °C.

We identified the wild strain as an ecological type of *Azolla imbricata* and designated it *Azolla imbricata* Fangshan. (Throughout the remainder of this discussion we will refer to it simply as *A. imbricata*.) *A. imbricata* is the northernmost distribution boundary of Chinese wild *Azolla* found to date, and its ecological adaptation to northern China is strong. It belongs to thermophilic *Azolla* sp. and its beginning growth temperature is about 10°C, higher than that of *A. filiculoides*. Its optimum growth temperature is 25-28 °C and its high temperature tolerance may exceed 40 °C. The light requirement of *A. imbricata* is not very strict, but the most favorable light intensity ranged from 40 to 60 klx. It grows better than *A. filiculoides* under both strong and weak illumination. *A. imbricata* is responsive to fertilization, growing faster and having higher nitrogenase activity in earthworm manure nutrient solution. Its N₂-fixing capacity increased with the addition of P, K, and microelements Fe, Zn, Cu, and B.

A. imbricata propagates primarily by vegetative reproduction. It can overwinter in streams and rice fields, but produces fewer sporocarps in the spring. *A. imbricata* recovers earlier and grows more vigorously after naturally overwintering than other *Azolla* strains, although it does not perform as well as *A. filiculoides* in early spring and late autumn. *A. imbricata* reached its peak growth rate in the field between 25 and 28 May. Under optimum conditions its propagative index exceeded 0.3, higher than that of *A. filiculoides* by 3-14%, and its doubling time was 2 d. The oversummering ability of *A. imbricata* is strong, too. By cultivating *A. imbricata* year round, yields of 300-375 t *Azolla* fresh wt/ha are possible, and in association with rice, yields of 75-150 t/ha are realized.

A. imbricata not only grows rapidly, it also has high N₂-fixing capacity, reaching 0.69-1.77 g/g per m² per d in late May. Its acetylene reduction capacity is 3-5 nm of C₂H₄/g fresh wt per min.

There are more algae and heterocysts in the leaf cavities of *A. imbricata* than in *A. filiculoides*.

Culturing *A. imbricata* in the field increases rice yield and improves soil fertility because of its higher N content (3.4-4.2%), lower C:N, and faster decomposition. Field experiments from 1982 to 1984 showed that rice yields could be increased 16-35% by incorporating *Azolla* basally or applying it as a topdressing. *A. imbricata* is high in N and protein, and it contains more amino acid than *A. filiculoides* or *A. imbricata* Nanjing. Total amino acid content of *A. imbricata* is 20.107 g/100 g dry wt compared to 16.631 g/100 g dry wt for *A. filiculoides*, and 15.354 g/100 g dry wt for *A. imbricata* Nanjing. It is important to develop *A. imbricata* Fangshan for multiple uses in crop production, fodder, and fish food.

THE ECONOMIC VALUE AND USE OF RED DUCKWEED *AZOLLA* SP. IN ANHUI PROVINCE, CHINA

Xi Qie-ming

Soil and Fertilizer Institute

Anhui Academy of Agricultural Sciences, China

Since the 1950s, *Azolla* has been used in agriculture and animal husbandry in Anhui Province, China. *Azolla* (red duckweed) contains 4-5% nitrogen and is a good and inexpensive fertilizer for crops such as rice, wheat, rape, cotton, taro, bean, and tea, and a good and inexpensive feed for fish and livestock. Under

the most favorable conditions, 600,000 kg fresh *Azolla* can be harvested from 1 ha. Applying 150,000 kg of *Azolla* in a 1-ha paddy field can increase rice yield 20-30%.

There are many ways to extend *Azolla* production. *Azolla* can be raised in the field after wheat, barley, rape, broadbean, and cowpea, or after seeds of milk vetch had been harvested. In late spring and early summer, *Azolla* yield can be doubled within 3-5 d without injury to the rice plants.

Damp open ground and pond can also be used for *Azolla* cultivation. Industrial production of *Azolla* ensures year-round cultivation.

Red duckweed can produce large and small sporocarps under unfavorable conditions. In Anhui Province, the sporocarps can survive through winter and summer and are grown and reproduced artificially.

Strong light and high temperature, and low temperature and weak light do not favor *Azolla* growth. The most favorable temperature is 20-30 °C. The amount of light necessary for good *Azolla* growth differs according to variety. In spring and autumn, 60-80% of full daylight will be sufficient for growth; in summer, 10-20%. In winter, full light will be necessary. The optimum pH value of soil is 5.5. Phosphorus is most essential for normal growth of *Azolla*. Fe, Mo, Ca, K, and Co are also essential.

CICHLASOMA AND *TILAPIA* SELECTIVE APPETENCY FOR *AZOLLA*

T. Antoine, S. Carraro, J.C. Micha, and C. Van Hove
Universite Catholique de Louvain
Laboratoire de Physiologie Vegetale,
Laboratoire des Eaux et Forets,
Place Croix du Sud, 4, B-1348 Louvain-la-Neuve
Belgium

Selective appetency of two fish, *Cichlasoma* sp. and *Tilapia nilotica*, for *A. caroliniana*, *A. filiculoides*, *A. microphylla*, *A. pinnata* var. *imbricata*, and *A. pinnata* var. *pinnata*, each one represented by five strains, was tested. Plant samples used for feeding experiments were collected in the linear phase of their growth curve. In all instances, *A. microphylla* was the preferred species for *Cichlasoma*, generally followed by *A. caroliniana*. *Tilapia nilotica* nearly always selected *A. filiculoides* first, and *A. microphylla* second. The two *A. pinnata* varieties were always practically neglected by the two fish. When the five *A. microphylla* strains were presented to *Cichlasoma*, significant strain

preferences appeared. *Azolla* selection for feed must take into consideration the aptency of the animal species concerned for *Azolla* at the species and even strain level.

STUDY ON *AZOLLA* AS A FISH FODDER

Chen De-fu and Huang Chun-yuan
Institute of Soil Fertilizer
Zhejiang Academy of Agricultural Sciences
Hangzhou, China

Fresh *Azolla* is tender and is preferred to dry wheat bran by herbivorous and omnivorous fish. Six species of *Azolla*, however, vary in their edibility, and even the same species may have different edibility for different fish species. *Azolla* is rich in nutrients. The crude protein and crude fat contents of *Azolla* usually exceed those of wheat bran. The nutrient content of *Azolla* is influenced by seasonal variations and culture techniques. The feed coefficient of *Azolla* is 20-50. That means that the nutrient value of 10-20 kg fresh *Azolla* is equivalent to 1 kg dry wheat bran. Fish fed a combined ration of *Azolla* and mixed fodder yielded more than fish fed with either *Azolla* or mixed fodder alone. *Azolla* is a potential source of fish fodder due to its high yield, enriched nutrients, good edibility, and lower feed coefficient.

THE ROTATION OF RICE AND *AZOLLA* FOR RATIONAL USE OF PERENNIALY SUBMERGED LAND

Zhang Chunlun
Soil and Fertilizer Institute
Sichuan Academy of Agricultural Sciences
Sichuan, China

Perennially submerged land accounts for a large area in the rice belt of Sichuan Province. Although the area has been reduced through reclamation over many years, there still are about 1.3 million ha. Only 1 rice crop a year is cultivated on these lands and the fallow period reaches 200-260 d annually, meaning that only 32-33% of the light and heat energy available can be fully utilized. The

rotation of rice and *Azolla filiculoides* Lam. raises the level of nutrient exchange and the economic efficiency of perennially submerged lands.

The area devoted to this rotation pattern rose from 80,000 ha in 1981 to 127,000 ha in 1983. Adding to that the area in which *A. imbricata* grows in natural association with rice, the total area in which *Azolla* is associated with rice culture exceeds 130,000 ha. Although the input-output ratio declined when *Azolla* and mineral fertilizer were applied in combination, nutrient output reached the maximum. Therefore, we conclude that *Azolla* and mineral fertilizer applied in combination is an effective way to increase crop yield. The percentage nutrient availability of NPK increased when *Azolla* was applied in combination with mineral fertilizer. N availability went to 59.1%, a 51.7% increase; P to 120.9%, up by 46.4%. K availability rose to 113.6%, a 72.3% increase over *Azolla*.

In a two-crop pattern of rice and wheat, nutrient availability for the wheat crop also increased. N availability went to 39.3%, up by 35.3%; P availability rose to 55.0%, up by 23.7%; and K availability went to 104.9%, a 52.5% increase. In the 2-crop system the decomposition of incorporated *Azolla* ranged from 37.7 to 38.8%. When *Azolla* was incorporated into the soil for the rice crop, decomposition was rapid but there was no succeeding availability of nutrients for the wheat crop. When *Azolla* was incorporated with the wheat crop, decomposition was slower but there was succeeding nutrient availability for the rice crop.

Azolla significantly raises the fertility of rice soils. The primary effect is to increase cation exchange capacity from about 0.94 to 1.63 meq/100 g soil and to improve the colloidal property of the soil. At the same time, soil physical properties are improved. Organic matter increases from 0.17 to 0.26%, and total N from 0.003 to 0.016%. Microaggregates (0.25 mm diam) increased 3.3%, compression strength declined by 1.5 kg/cm², and bulk density went down by 0.060.

On 1 ha of rice soil 15 t fresh wt *Azolla* could be produced to improve more rice fields in expanding agricultural production.

STUDY OF UTILIZATION OF *AZOLLA* IN PADDY FIELDS IN BEIJING

Wang Pu and Wang Zai de
Beijing Agricultural University
Beijing, China

The paddy yield and effect on soil of *Azolla imbricata* (Fangshan) and *A. filiculoides* were studied under Beijing ecological conditions in 1983-84.

The trials were carried out at 3 transplanting patterns, 1) wide-narrow row ($46.7 + 13.3 \times 10$ cm), 2) wide row (30×20 cm), and 3) traditional pattern (20×15 cm), and at 3 levels of N application, 0, 45, and 90 kg/ha. The optimum amounts and application methods were selected. Biomass and paddy yield showed significant differences among treatments. Incorporating 45 t *Azolla* fresh wt/ha increased paddy yield by 35% in the first crop, equivalent to that obtained from 90 kg N/ha applied as ammonium sulfate. An additional yield increase of 5-10% was realized from the second crop. *A. imbricata* gave the higher yield increase. The highest yield was obtained from the wide row transplanting pattern.

The effect of *Azolla* on rice growth and development may be divided into three stages:

1. Transplanting to tillering (15 d): The greening and tillering of seedlings were slightly inhibited due to absence of nutrients and presence of toxic materials when only *Azolla* was applied basally.
2. Beginning normal seedling growth (7-10 d).
3. Beneficial effect of *Azolla* gradually appears: *Azolla* incorporated into the soil decomposed and mineralized rapidly. Seedlings developed dark green leaves and grew much more vigorously than seedlings in plots that received no *Azolla*.

Rice growth was promoted during stages 2 and 3. Plants in plots fertilized with mineral N were yellowish and grew slowly. *Azolla* promoted rice growth mainly in the mid and late stages during young panicle development. The effects of *Azolla* were seen in the increased number of panicles, greater panicle size, and increased number of grains. Higher yields of rice and *Azolla* were achieved with wide row transplanting. *Azolla* combined with N fertilizer gave the highest yields. The best way to utilize *Azolla* in rice fields is with a mixed culture of *A. filiculoides* and *A. imbricata* supplemented with 67.5 kg N/ha, and wide row spacing. Highest yields were achieved when a successive crop of *Azolla* was grown in the field and 45 kg N/ha was applied. The optimum organic to inorganic ratio is 2:2.5.

Azolla markedly increased soil fertility through the addition of biomass, C, and N. Soil organic matter increased by 10.3% and water-soluble N by 11.1% in the 0-20 cm soil layer. Total soil N content showed no significant increase. *Azolla* helps maintain soil nutrient balance and significantly improves soil structure—soil porosity increased 11.9%, compressive strength decreased 67.9%, and bulk density decreased 9.3%. Weeds in *Azolla* plots were reduced 84-92%.

Cultivating *Azolla* in rice fields is ecologically sound and economical. It mitigates insects and diseases, reduces the risk of pollution from excessive use of mineral N and pesticides, and improves the overall quality of rice products.

EFFECT OF SOIL CONDITIONS ON THE DECOMPOSITION RATE OF *AZOLLA*

Lin Xinxiong and Wen Qixiao
Nanjing Institute of Soil Science
Academia Sinica
Nanjing, China

Azolla can be cultivated and used as green manure in most rice fields in China. Because the decomposition rate of *Azolla* is an important factor determining its effect on rice growth, a series of decomposition experiments, using the carborundum tube method, were conducted at four sites in different climate zones in 1980. The climate zones were southern subtropic (Guangzhou), northern subtropic (Wuxi), warm temperate (Tianjin), and temperate (Gongzhuling). The mean annual temperature in the 4 zones ranged from 21.8 to 4.9°C, and mean annual precipitation was from 1,623 to 572 mm. The soils in Tianjin and Gongzhuling are calcareous, those in Guangzhou acidic, and those in Wuxi neutral. Under waterlogged conditions, the *Azolla* decomposition rate was highest in Tianjin soils, lower in Guangzhou, and lowest in Gongzhuling. Under upland conditions, the decomposition rate of *Azolla* was highest in Guangzhou soils and lowest in Wuxi soils. These results may seem contradictory to the general belief that the decomposition rate of plant residues doubles for every incremental temperature increase of 10°C. This apparent anomaly is explained by the fact that the soils at the four sites differed greatly in acidity, texture, clay mineral, and, in the case of upland, soil water regime. It is well known that plant residues decompose more rapidly in calcareous soils than in acidic soils, and that water shortage limits microbial activity. We conclude that the decomposition rate of *Azolla* in soils is governed not only by climate but by soil properties as well.

Under all conditions, however, the decomposition rate of *Azolla* was lower than that of rice straw under the same conditions, because *Azolla* has a much higher lignin content ($22.0 \pm 6.6\%$). It is well demonstrated that the humification coefficient of plant residues correlates significantly with their lignin content, irrespective of climate and soil type.

THE CULTIVATION OF *AZOLLA FILICULOIDES* FOR THE RECLAMATION AND UTILIZATION OF HEAVY SALINE SOIL

Shang Deng-hui, Wu Ho, and Chen Xi-pan
Xin Yang Agricultural Experimental Station
Yan Cheg, Ziangsu, China
and
Gu Rong-sain
Institute of Soil Fertilizer
Ziangsu Academy of Agricultural Sciences
Nanjing, China

Experiments have shown that the salt-resisting limit of *Azolla filiculoides* is 0.7% (salt water) and its alkali-resisting limit is 0.3% ($\text{Na}_2\text{CO}_3 + \text{NaHCO}_3$). Therefore, it can be cultured as a pioneer plant for reclaiming coastal heavy saline soil. Cultivated on soil containing 0.35% salt for 110 d and irrigated with water containing 0.2% salt, *Azolla* produces 90-105 t fresh wt/ha, or an average daily yield of 818-955 kg/ha. During the same period, *Sesbania* produces only 21.2 t fresh wt/ha. When *A. filiculoides* is cultured with seawater containing 0.1-0.5% salt, it has a nitrogenase activity of 0.5-0.25 $\mu\text{m C}_2\text{H}_2/\text{g}$ fresh wt per ha. *A. imbricata* cultured with seawater containing 0.3% salt shows no nitrogenase activity.

By cultivating *Azolla* in spring and autumn for 2 successive years, the salt content of saline soil may be decreased from 0.35 to 0.1%. The desalination rate is 71.4%, 1.8 times higher than that of water leaching or 2.1 times that of *Sesbania*. The humification coefficient of *Azolla* is 0.42, higher than that of *Spartina anglica* (0.19-0.25), *Sesbania* (0.32), or ryegrass (0.22). Thus, after 2 yr, the organic matter in the 0-10 cm soil layer increases from 0.58 to 1.10%. The rate of increase is higher than that achieved by planting *S. anglica* or *Sesbania* during the same period. Soil fertility is improved to the level of a soil that can yield 2.3-3.0 t seed-cotton/ha. Reclamation for 2 successive years by cultivating *Azolla*, *Sesbania*, and ryegrass gives a higher net income from cotton than other reclamation methods.

STUDIES ON *AZOLLA* MINERALIZATION RATE AND NUTRIENT RELEASING DYNAMICS

Wang De-xian, Zhao Miao-zheng, and Chen De-fu
Institute of Atomic Energy Utilization
Zhejiang Academy of Agricultural Sciences
China

The mineralization of *Azolla filiculoides* and *A. imbricata* was studied under flooded conditions in pots. The samples were labeled with ^{14}C carbon dioxide and ^{15}N ammonium sulfate. Most mineralization takes place within 9 wk after fresh *Azolla* is added to the pots and then drops sharply and remains at a low level for some weeks thereafter. More than half of the mineralization takes place within the first 6 wk, although the amounts mineralized are highest in the 2d and 3d wk.

Two factors seem to influence the speed of mineralization and the quantity of N released: 1) soil type and other environmental conditions, and 2) the C:N of the *Azolla*. The speed of mineralization and quantity of N released are enhanced by increasing release of nitrogen compounds and decreased C:N. *A. filiculoides* released more N at a faster rate than did *A. imbricata*. Early maturing rice plants absorbed 14.8% of total N compounds released by *A. filiculoides* and 13.6% of the N compounds released by *A. imbricata*. Late maturing plants absorbed 5.4% of the N compounds released by *A. filiculoides* and 4.6% of the N compounds released by *A. imbricata*.

Azolla not only supplies nutrients to crops directly, it also promotes the mineralization of other organic compounds by activating microorganisms present in the soil. Although ammonium sulfate releases N more rapidly, N-release of *Azolla* is more constant and yields are higher.

To compensate for the loss due to mineralization of other organic compounds in soil and to provide adequate nutrition to the rice plant, an application of 22.5 t *Azolla* /ha is recommended.

ESTIMATION AND UTILIZATION OF THE CONSTANT OF THE EFFECTIVELY ACCUMULATED TEMPERATURE OF *PYRALIS* SP. AND *NYMPHULA ENIXALIS*

Zhu Zhonglin and Jian Soufa
Soil and Fertilizer Institute
Sichuan Academy of Agricultural Sciences
Sichuan, China

Pyralis sp. and *Nymphula enixalis* Swinhoe are the main pests of *Azolla*, and are commonly found in China, Vietnam, and other countries. Estimation and utilization of the effective temperature summation constant would be an economical and effective key to their control. The feeding habits of the two insects were studied in feeding cages in the field to determine the effects of natural temperature changes on the number of generations and on the development stages of the pests during the course of a year. The insects were fed *Azolla imbricata* Nakai and *A. filiculoides* Lam. Daily average temperature was determined by standard meteorological methods.

The results of the study are as follows:

1. There was a direct relation between temperature and the development rate of the pests. Based on the rule of effective temperature summation, the heat energy required by insects to complete a given developmental stage is constant. Under natural conditions, the threshold temperatures for development stages of *Pyralis* sp. is 11.2 ± 1.3 for egg, 12.3 ± 0.7 for larva, 13.1 ± 1.1 for pupa, and 12.2 ± 0.5 °C for adult. For *N. enixalis* they are 14.8 ± 1.3 for egg, 9.8 ± 1.4 for larva, 13.1 ± 0.7 for pupa, and 10.1 ± 1.0 °C for adult. The effective temperature summation in degree days for growth stages of *Pyralis* sp. was 53.0 for egg, 131.9 for larva, 66.3 for pupa, and 263.1 for adult. For *N. enixalis* it was 41.8 for egg, 137.3 for larva, 64.3 for pupa, and 397.3 for adult.
2. The effective temperature summation required for generations of the two pests varied with climate. We found that we could estimate the annual number of generations of the two pests according to the average temperature of a decade of days in Kuanchow, Wenchow, Tzengsa, Giajiang, and Yi-qutse counties of Sichuan Province. The area ranges from 23° 8' to 30° 34' N latitude, from 103° 33' to 120° 40' E longitude, and from 6 to 407 m above sea level. This demonstrates that the effective temperature summation could be used to forecast the generations of the two pests in the southern part of the Yangtze River, which is the major area of *Azolla* distribution.

3. The effective temperature summation constant might be used to forecast the number of generations that would occur for the two pests, forecast the development stage of either pest, or to forecast the extent of damage the two pests could cause in the forthcoming year.

The equation for forecasting the number of generations is

$$n = N_i \sum \frac{[t_i - (C + SC)]}{K}$$

where N_i = day i of a decade and t_i = average daily temperature. The successive stages can be predicted when the additive value of the effective temperature summation approaches the effective temperature summation constant by the equation

$$\frac{K}{[t - (C \pm SC)] - 1}$$

Forecasting damage likely to be caused by the two pests in the ensuing year is a function of the main stages of the pest to overwinter. When daily average temperature fell below 9.8 °C, we sampled the stages of the two pests most likely to overwinter. If larvae, especially younger ones, are the main stage to overwinter and their survival rate is likely to be high, then heavy damage can be expected the next year.

The characteristic damage to *Azolla* by *Pyralis* sp. and *N. enixalis* can be forecast. The beginning point of the effective temperature summation for the larvae of *Pyralis* sp. was significantly higher than that for *N. enixalis*. Therefore, the stage causing serious damage to *Azolla* would be later for *Pyralis* sp. On the other hand, the effective temperature summation for a generation of *Pyralis* sp. was lower than that of *N. enixalis*. As a result, the annual number of generations of *Pyralis* sp. that would occur would be more than the generations of *N. enixalis*. Therefore, more damage would be expected to be caused by *Pyralis* sp.

4. Neither *A. imbricata* Nakai nor *A. filiculoides* caused any differences in the generation duration of the two pests. In practice, then, allowing the pests to feed on *A. imbricata* would control the pest on *A. filiculoides* in production.

ESTIMATION OF N₂ FIXATION AND EXCRETION OF *AZOLLA* BY THE ¹⁵N DILUTION TECHNIQUE

Chen Binghaun, Zhang Weiguang, Tang Jianyang,
and Liu Chungzhu
Azolla Research Center
Fujian Academy of Agricultural Sciences
Fuzhou, China

Take *A. imbricata* Putian as the main material and algae-free Putian *Azolla* and *Lemna minor* as reference plants. Culture them in IRRI nutrient medium or water-soil system in the greenhouse. Design a kind of installation used to adjust the space of stable density for *Azolla* growing. Provide suitable growing conditions.

If the nutrient medium contains N within 5-100 ppm, N₂ fixation decreases as the concentration of N increases, but the N that *Azolla* contains peaks. The highest is between 20 and 40 ppm, and it will decrease in turn toward both sides.

The ¹⁵N dilution technique and acetylene reduction method are used.

The N₂ rate of *A. imbricata* Putian has been calculated by ¹⁵N dilution technique: 11.65 and 10.79 kg N/ha (growth period of 18 d).

In the nutrient medium in which *Azolla* was grown, ¹⁵N abundance is diluted by the N which *Azolla* excretes. When N concentration of IRRI nutrient medium is low it will be diluted greatly, but if the N concentration is high, it will be less diluted. But the estimations by ¹⁵N dilution technique give contrasting results. The N excreted by *Azolla* which remained in the high concentration nutrient medium is more than the low one.

The test shows that *A. imbricata* Putian, algae-free Putian *Azolla*, and *Lemna* can recover the N excreted by *Azolla*. The absorptivity of *A. imbricata* Putian is closer to that of algae-free Putian *Azolla*.

RESPONSE OF *AZOLLA* TO PHOSPHORUS, POTASSIUM, AND ZINC IN DIFFERENT PADDY SOILS

Sikander Ali

Nuclear Institute for Agriculture and Biology (NIAB)

Faisalabad, Pakistan

and

I. Watanabe

International Rice Research Institute

P.O. Box 933,

Manila, Philippines

Eleven Philippine soils with various capacities to support *Azolla* growth in the field were examined for their capacities to support *Azolla* growth with the addition of P, K, and Zn. Soil samples were placed in 10-cm-diam brown bottles and flooded for 1 wk. *Azolla*, previously depleted of nutrients, was inoculated with 5 treatments (0 additional nutrients; complete P, K, and Zn; and -P, -K, and -Zn) and grown for 3 wk. P, K, and Zn contents in floodwater and the harvested *Azolla* were determined. *Azolla* dry wt ranged from 10 to 50 mg/10 cm² and N content ranged from 1.9 to 5.1% dry wt. Because P content in floodwater decreased sharply after P application, there was no additional increase of *Azolla* P content by P application, and *Azolla* growth was determined largely by the indigenous level of P in floodwater. *Azolla* biomass correlated highly with its N% ($r = 0.954$), and N% correlated highly with P content in floodwater ($r = 0.797$). P-deficiency threshold values appear to be 0.1 mg/liter in floodwater and 0.1% in *Azolla* dry matter. Available P (Olsen P) correlated lower with P content in *Azolla* ($r = 0.861$) than in floodwater ($r = 0.903$).

In some soils high in floodwater P, elimination of K (in two soils) and Zn (in one soil) reduced *Azolla* growth, but it was difficult to draw any conclusion on the threshold values for K and Zn deficiency. We could conclude, however, that P availability was the most limiting growth factor for *Azolla* in Philippine soils.

MICRONUTRIENTS AND THE ACTIVITY OF NITROGENASE IN *AZOLLA*

Wei You-zhong, Yang Yu-ai, and Sun Xi
 Department of Soil Science
 Agricultural University of Zhejiang
 China

The materials used in this experiment were *Azolla imbricata*, *A. japonica*, *A. filiculoides* (E. G.), and *A. filiculoides* (ph). Plant samples were incubated in a nutrient solution of demineralized water containing known amounts of nutrients. After incubation, the plants were analyzed for N, P, Si, Ca, Mo, Mn, Fe, Cu, Zn, Co, and B. *Azolla* had higher concentrations of these elements than the nutrient solution, demonstrating that *Azolla* has the ability to concentrate these elements from solution.

Nitrogenase activity was measured by the acetylene reduction method. The series of activities were *A. japonica*, *A. filiculoides* (E.G.), *A. filiculoides* (ph), *A. mexicana*, and *A. imbricata*.

The correlation between nitrogenase activity of (X) and Mo (Y_1) of all the *Azolla* samples tested is at the 1% level of significance, while Cu (Y_2) is at the 5% level of significance. Under experimental conditions the regression equations are:

$$Y_1 = -2.71 + 2.43 X; Y_2 = 0.529 + 0.294 X.$$

The rate of growth and N_2 fixation capacity of *Azolla* have been calculated. The series of the rate of growth is *A. filiculoides* (ph) > *A. filiculoides* (E.G.) > *A. japonica* > *A. imbricata*. Nitrogen-fixing capacity in order is *A. japonica* > *A. filiculoides* (E.G.) > *A. filiculoides* (ph) > *A. imbricata*. In nutrient concentrations, nitrogenase activity, rate of growth, and N_2 -fixing capacity, *A. japonica* and *A. filiculoides* (E.G.) are superior.

A. filiculoides (E.G.) was taken as an example for calculating the correlations among the essential nutrients. N and Mo, N and Fe, and Ca and Co correlated positively. The correlations between P and Cu and between P and S were negative. Cu and Mo, Fe and Mo, P and Zn, Ca and B, and N and Cu had higher correlations. The results indicate that nutrient solution and fertilization affect the performance of *Azolla*.

DIURNAL AND SEASONAL VARIATION IN THE NITROGENASE ACTIVITY OF *AZOLLA*

Zheng Wei-wen and Lu Pei-ji
Soil and Fertilizer Institute
Fujian Academy of Agricultural Sciences (FAAS)
Fuzhou, China

The experiment was conducted in a field at FAAS. We measured the nitrogenase activity of *A. filiculoides* Lam., *A. caroliniana* Willd, and *A. imbricata* (Roxb) Nakai by the $C_2H_2-C_2H_4$ assay in spring, summer, autumn, and winter in 1982-83.

The results demonstrated that the nitrogen fixation of *Azolla* is a dynamic process in which changes in sunlight intensity and water temperature can cause day-to-day variation in the nitrogenase activity of *Azolla*. Generally, the nitrogenase activity of *Azolla* peaks at about 1400 hand minimum activity is at zero hour. The amount of N_2 fixed by *Azolla* during the dark period (at night) is roughly one-half of that during daylight.

The activity of these kinds of *Azolla* is higher in spring and autumn than in winter and summer. Except for *A. caroliniana*, the rather low activity of *A. filiculoides* and *A. imbricata* is observed in summer. The sensitivity of *A. caroliniana* to light and temperature is lower than those of *A. filiculoides* and *A. imbricata*. This result is consistent with those of other experiments which show *A. caroliniana* is relatively both intensive light resistant and shade tolerant. The optimum light intensity of N_2 fixation for *Azolla* is 40-60 klx and temperature is 20-30 °C.

INFLUENCE OF NITROGEN NUTRITION ON THE PHYSIOLOGICAL PROPERTIES OF *AZOLLA*: EFFECT OF UREA

Ren Yun and You Chongbiao
Institute for Application of Atomic Energy
Chinese Academy of Agricultural Sciences, Beijing, China
and
Wei Wen-xiong
Azolla Research Center
Fujian Academy of Agricultural Sciences, Fuzhou, China

It has been previously reported that the nitrogenase activity of *Azolla* is inhibited by nitrogen sources, i.e. urea, ammonia, ammonium nitrate, and nitrate.

Results of experiments showed that calcium level affects the physiological properties of *Azolla*. This is important in South China where calcium level in the paddy soil is low. The toxicity of urea on *Azolla* increased with increased concentration on low-calcium soil.

THE TOLERANCE AND CONCENTRATION CAPACITY OF *AZOLLA* TO 11 METAL IONS

Wen Yong-huang and Xiang Wei-zhen
Department of Soil Fertilization
Jiangxi Academy of Agricultural Sciences
Nanchang, China

The tolerance of four *Azolla* species to Cu, Mn, Fe, Zn, Mo, Co, Cd, As, Hg, Cr, and Pb ions under laboratory conditions was studied. The concentrating capacity of *Azolla* for metal ions seems to affect their growth only slightly or not at all. The ability of *Azolla* to concentrate metallic elements such as Pb, Mn, Fe, Mo, and Zn, without detrimental effects on its growth, may play a more important role in the practical applications of *Azolla*.

STUDY ON THE MULTIRANKED TECHNIQUE OF *AZOLLA* CULTURE

Wen Yong-huang and Xiang Wei-zhen
Department of Soil Fertilization
Jiangxi Academy of Agricultural Sciences
Nanchang, China

The short utilization time and long seed storage time of *Azolla* are the main constraints to its application to rice production. To find ways to overcome these constraints, multiranked greenhouse experiments on the techniques of *Azolla* culture were conducted for 1 yr. The results indicate that the multiranked technique of *Azolla* culture is characterized by high biomass yield. The highest yield was recorded in the 6th-ranked frame with a yield of 572 t *Azolla* fresh wt/ha per year, or 54 t *Azolla* dry wt/ha per year. The multiranked technique of *Azolla* culture is characterized by fewer disease and insect pests, simple and convenient management, year-round culture, and full utilization of space, light, and heat. The main factors influencing biomass yield by multiranked culture techniques were also investigated.

TOLERANCE OF *AZOLLA CAROLINIANA* AND ITS APPLICATION

Wei Wen-xiong, Ye Guo-tian, Zheng Guo-zhang,
Cheng Feng-yue, Jin Gui-ying, Liu Pei-ji,
and Zheng Wei-wen
Azolla Research Center
Fujian Academy of Agricultural Sciences
Fuzhou, China

Results of laboratory single-item tests and field integrated experiments showed that *Azolla caroliniana* has a broad-spectrum stress tolerance — snail tolerance, mildew resistance, insect resistance, water algae tolerance, low (below 0°C) and high (41°C) temperature tolerance, and shade tolerance (normal growth under weak light intensity, average 3,000 lx/30°C d). Thus, *Azolla* can naturally overwinter and oversummer in Fujian climatic conditions and can be cultured under rice plants, with the ability to supply *Azolla*

fertilizer (decayed in rice field) of about 15 t/ha. It can still grow on soil surface after drainage, supplying fresh *Azolla* at 11.2 t/ha. When applied after harvest as base fertilizer for the next crop, *Azolla* can increase yield 13.2%. *A. caroliniana* can also be used as fish feed in rice fields and ponds especially from June to August. Results of experiments where rice and *A. caroliniana* were grown together in the same field for 4 yr have shown increased rice yield potential.

EFFECT OF THE BIOPESTICIDE B.T.I. ON THE CONTROL OF CHIRONOMIDS (*POLYPEDILUM IUINOENSE* HAUBER)

Lu Pei-ji and Lin Chang
Soil and Fertilizer Institute
Fujian Academy of Agricultural Sciences
Fuzhou, China

Greenhouse and field experiments were conducted to determine the effect of the biopesticide *B. thuringiensis* var. *israelensis* (BTI) on the control of the main pests of *Azolla*, the chironomids. Results show that BTI is excellent for controlling chironomids and can significantly reduce damage by chironomids.

The half-death dose to old larvae is 12.4 ppm. The 95% confidence limit is between 11.1 and 13.9 ppm. After 24 h of field spraying, average death rate of the pest is about 63%, and death rate could reach more than 90% after 3–4 d. BTI is superior to carbofuran in chironomid control and is cheaper.

BTI sprayed in paddy fields is not toxic to fish.

STUDY OF THE BIOLOGICAL PROPERTIES AND CONTROL OF *AZOLLA* MIDGE

Chen Jia Ju
Soil and Fertilizer Institute
Fujian Academy of Agricultural Sciences
Fuzhou, China

In South China, *Azolla* would die in summer. For a long time, people thought that *Azolla* death was due to high temperature in summer. The growth regularity of *Azolla* was studied in 1976. We found that *Azolla* death was not due to high temperature but to an injurious insect, *Azolla* midge, which is aquatic at larval instar stage. This injurious insect is light red and has a body length of 2-3 mm. It makes its nest on the underside of *Azolla* and eats the root and young leaf during summer. Several chemical insecticides had been applied but were ineffective. During summer, the insect population could increase to 90,000/m². *Azolla* is completely damaged in 3-5 d.

Investigations on *Azolla* midges were done in Southeast Fujian. The midges in the fields included *Polypedilum iuinoense* Hauber, *Tendipes attenuatus* Walker, *Tendipes riparius* Meigen, and *Cricotopus trifasciatus* Panzer. *Polypedilum iuinoense* Hauber brought the most damage to *Azolla*.

There could be as many as 16 generations of *Polypedilum iuinoense* Hauber per year in Southeast Fujian. A life cycle is completed in 12 d in summer and 57 d in winter. The larvae survive in winter.

There are many ways to prevent damage by *Azolla* midge. One is by protecting Dytiscidae, one of the natural enemies of *Azolla* midge. UV light lamps also provide efficient control of the *Azolla* midge. Some chemical insecticides such as deltamethrin, carbofuran, carbaryl, and temephos can be used without causing injury to *Azolla*. Maceration extract of cake of tea oil is ideal for control of *Azolla* midge.

EFFECT OF INSECTICIDES ON THE GROWTH AND NITROGEN FIXATION IN *AZOLLA*

S. Kannaiyan and K. Nandabalan
Department of Agricultural Microbiology
Tamil Nadu Agricultural University
Coimbatore 641003, Tamil Nadu, India

A field experiment was conducted to study the effect of different insecticides on the growth and nitrogen fixation in *Azolla*. Plot size was 10 × 2 m and Pas single superphosphate was applied basally at 15 kg P/ha. The insecticides tested were furadan, monocrotophos, phorate, thiodan, quinalphos, carbosulfan, and chlorpyrifos. Furadan (3% G) and phorate (10% G) were broadcast at the rate of 0.5 kg ai/ha. Monocrotophos (36% EC) at 0.072%, thiodan (35% EC) 0.05%, carbosulfan (24% EC) 0.048%, and chlorpyrifos (20% EC) 0.04% were sprayed. *Azolla* was inoculated at 200 g/m² and *Azolla* biomass yield was recorded on the 14th day. *Azolla* samples were drawn from each treatment on the 14th day and nitrogenase activity was estimated. All *Azolla* biomass yield was higher in all treatments than in the control. Monocrotophos treatment resulted in the highest *Azolla* biomass. Insecticides significantly increased the nitrogenase activity over the control.

Quinalphos showed the highest nitrogenase activity. The results show that the application of insecticides significantly stimulated nitrogenase activity over that of the control.

In another study the effect of treating *Azolla* fronds with furadan on the growth of *Azolla* and activity of ammonia-assimilating enzymes was investigated. Plot size was 5 × 2 m and P as single superphosphate was applied basally at 15 kg/ha. *Azolla* was treated with furadan at 2, 4, 6, 8, 10, and 12% by weight. The treated fronds were kept in shade 8 h before being inoculated in the field at the rate of 200 g/m². Fresh weights of *Azolla* biomass were recorded on the 14th day. The activities of ammonia-assimilating enzymes GA, GOGAT, and GDH were estimated. Furadan at all concentrations reduced *Azolla* growth compared to control. The reduction in *Azolla* growth was considerable at 6-12% concentrations. An increase in the GS activity and a decrease in the GDH and GOGAT activities in *Azolla* were seen. GDH and GOGAT activity decreased considerably as furadan concentration increased. GS activity was stimulated up to 8% level.

INFLUENCE OF NEEM CAKE ON BLACK ROT DISEASE INCIDENCE IN *AZOLLA*

S. Kannaiyan and K. Nandabalan
Department of Agricultural Microbiology
Tamil Nadu Agricultural University
Coimbatore 641003, Tamil Nadu, India

Black rot disease in *Azolla* caused by *Rhizoctonia solani* is common and reduces biomass. Disease severity is higher when the fronds are attacked by snails. The occurrence of black rot disease in different species of *Azolla* was investigated in pot culture. *Azolla caroliniana* had the lowest disease incidence followed by *A. pinnata* (Bangkok strain). The maximum incidence of the disease was found in *A. nilotica*. Another pot culture experiment was conducted to study the effect of neem cake on black rot disease incidence and its influence on N₂ fixation in *Azolla*. Cement pots 1 × 0.5 m were used. Two kg of soil was added to each pot and 10 cm water level was maintained. Neem cake was applied at levels equivalent to 100, 200, 300, 400, and 500 kg/ha. *Azolla* was added at the rate of 200 g/m². *Azolla* fronds were inoculated with *Rhizoctonia solani* and added to the pots. Black rot disease incidence was calculated as the percentage of affected fronds to the number of fronds per 10 cm². Fresh weights of *Azolla* biomass were measured on the 14th day and nitrogenase activity was estimated. A decrease in black rot incidence was recorded in the neem cake-treated *Azolla*. With increased dosage of neem cake biomass, yield increased and pest and black rot incidences decreased proportionately. Increased levels of neem cake stimulated nitrogenase activity. Neem cake at 500 kg/ha produced maximum biomass and nitrogenase activity, and the least insect and disease incidence.

THE DEVELOPMENT OF MICROSPORANGIA AND MICROSPORES IN *AZOLLA FILICULOIDES*

He Guo-fan and Lin Yue-chan
Department of Biology, Zhongshan University,
Guangzhou, China

This paper presents a detailed report on the developmental processes of the microsporangium and its microspores in *Azolla filiculoides* Lam. Scanning electron photographs show the morphological structures of the respective developmental stages. The entire developmental process may be divided into six stages:

1. Microspore mother cell initiating stage: The microsporangium initial on the placenta of the sporocarp gives rise to a sporogenous cell, and then divides 4 times to form 16 microspore mother cells.
2. Meiotic stage: Meiosis takes place inside the callose walls of the microspore mother cells.
3. Microspore shrinking I: After the callose walls of tetrads are dissolved, microspores released from the callose walls shrink intensely and then become spherical.
4. Microspore shrinking II: The microspores give rise to the second contraction.
5. Massulae forming stage: The sporoplasmodium successively dissolves and the microsporangium divides into several large vesicles, each of which will form a massulae.
6. Microspore germinating stage: Each matured microspore inside the massulae gives rise to an androgonal initial, which divides twice to form four antherozoid mother cells.

The relationships between the various morphological structures and their functions in the microsporangium developmental process are briefly discussed. In addition, our studies are compared with those of other investigators.

THE FLUORESCENT ANTIBODY STAINING REACTION OF *ANABAENA AZOLLAE* AND ITS CULTURES IN VITRO

Wei Wen-xiong, Jin Gui-ying, Zheng Wei-wen,
and Liu Chung-chu
Azolla Research Center
Fujian Academy of Agricultural Sciences
Fuzhou, China

Since 1982, the fluorescent antibody staining reaction has been used to test the degree of homology cell antigens of the three kinds of BGA: fresh *A. azollae* from *A. filiculoides* (F), and cultures in vitro from *A. filiculoides* (FC) and *A. imbricata* (IC). Three antisera were produced in rabbits. Various BGA cross-reacted identically with the three antisera.

The experiments suggested that drastic changes in the environment during isolation and culturing induce changes in the morphology of *A. azollae*. FC cells are smaller than F cells, for example, and the sheath (slime) outside FC cells is thicker than that of F cells. But similar immune fluorescent reaction appears to exist between fresh *A. azollae* and its cultures in vitro for a long time. When the antisera prepared against F were diluted more than 1000-fold, yellow green fluorescence on the surface of both F and FC cells was observed, although F cells had brighter fluorescence.

We also used these antisera to react with various species of free-living BGA. In about 12 samples, we observed the obvious difference on immune fluorescent reaction between the endogenous *A. azollae* cultures in vitro and free-living BGA.

Our preliminary results show that our pure cultures of *A. azollae* are the symbiont of *Azolla*.

A FLUORESCENT ANTIBODY ASSAY FOR DETECTING ANTIBODIES TO SURFACE ANTIGEN ON *ANABAENA AZOLLAE*: A PRELIMINARY REPORT

Tang Long-fei, Zhen Qi, Zhen De-ying, and Liu Chung-chu

Soil and Fertilizer Institute

Fujian Academy of Agricultural Sciences

Fuzhou, China

and

Cheng You-chuang and Lin Tian-long

Animal Husbandry

Fujian Academy of Agricultural Sciences

Fuzhou, China

A highly specific and sensitive fluorescent antibody assay suitable for detecting antibodies to surface antigen of *Anabaena azollae* has been developed. Results showed that the symbionts from *Euazolla* or *Rhizosperma* differ in their surface antigens. The symbiont from *A. caroliniana* (antigen) which belongs to *Euazolla* had a strong fluorescent reaction with the antiserum, whereas the symbiont from *A. imbricata* (*Rhizosperma*) had a weak reaction with the same serum.

Observations¹ of the shape of the nutrition cells of symbionts of *Anabaena azollae* showed that nutrition cells of the symbiont from *Euazolla* are like long cylinders whereas those of the symbiont from *Rhizosperma* are like short barrels.

¹ Part of the observations were made by Zhang Ning.

PRELIMINARY STUDIES ON ISOLATION AND FUSION OF *AZOLLA* PROTOPLASTS

Chen Wan-hua, Xie Ying-xian, and Chen Ting-wei
Soils and Fertilizer Institute
Chinese Academy of Agricultural Sciences
Beijing, China

The aim of this research was to develop efficient methods for the isolation, culture, and fusion of *Azolla* protoplasts for use in somatic hybridization experiments between different species of *Azolla*. Isolated protoplasts were obtained from *Azolla* using an enzyme solution composed of 0.6 M mannitol, 2% cellulase, and 1.5% macerage. Optimal conditions of isolation were tested. The greatest number of protoplasts was released at 30 °C after 12-15 h enzymatic digestion. The size of isolated protoplasts was mostly 20-30 μm diameter. Protoplast fusion was accomplished using polyethylene glycol. In most cases, protoplasts fused in pairs; occasionally three or four fused together. Further study along this line is continuing.

紅萍研究中心
AZOLLA RESEARCH CENTER



Participants

Sikander Ali

Nuclear Institute for Agriculture and Biology
Jhang Road, P.O. Box 128
Faisalabad, Pakistan

Bai Ke-zhi

Institute of Botany
Academia Sinica
Beijing, China

Ten Be

Ministry of Agriculture
Rangoon, Burma

C.R. Bersabe

Fertilizer Use and Promotion Section
Bureau of Soils
Ministry of Agriculture
Manila, Philippines

Chen Binghaun

Azolla Research Center
Fujian Academy of Agricultural Sciences
Fuzhou, China

Chen De-fu

Institute of Soil Fertilizer
Zhejiang Academy of Agricultural Sciences
Zhejiang, Hangzhou
China

Chen Wan-hua

Soils and Fertilizer Institute
Chinese Academy of Agricultural Sciences
Beijing, China

Chen Ying

Shanghai Plant Physiology Institute
China

Cheng Jia ju

Soil and Fertilizer Institute
Fujian Academy of Agricultural Sciences
Fuzhou, China

E. T. Craswell

Australian Center for International
Agricultural Research
Australia

E.G. Cutter

Department of Botany
University of Manchester
Manchester M13 9PL.
United Kingdom

John Dent

Food and Agriculture Organization
Asian Office

H.F. Diara

West Africa Rice Development Association
B.P. 96, Saint Louis, Senegal

D.G. Dunham

Department of Biological Sciences
Portsmouth Polytechnic
Portsmouth PO1 2DY, Hants
United Kingdom

D.L. Eskew

International Atomic Energy Commission
IAEA/FAO Joint Project
Vienna, Austria

M.F. Fiore

National Rice and Bean Research Center
Caixa Postal 179, 74000 Goiania
Goias, Brazil

K. Fowler

Department of Biological Sciences
Portsmouth Polytechnic
Portsmouth PO1 2DY, Hants
United Kingdom

D.J. Greenland

International Rice Research Institute
P.O. Box 933
Manila, Philippines

Gu Rong-sain

Soil and Fertilizer Institute
Jiangsu Academy of Agricultural Sciences
Nanjing, China

He Guo-fan

Department of Biology
Zhongshan University
Guangzhou, Guangdong, China

Hu Zhang-jia

Department of Soil Chemistry
Middle China Agricultural College
China

S. Kannaiyan

Department of Agricultural Microbiology
Tamil Nadu Agricultural University
Coimbatore 641003, Tamil Nadu
India

S.A. Kulasooriya

Department of Botany
University of Peradeniya
Peradeniya, Sri Lanka

J.K. Ladha

Soil Microbiology Department
International Rice Research Institute
P.O. Box 933
Manila, Philippines

A.C. Leviste

Kiwanis National Azolla Program
Ayala Kiwanis
Makati, Philippines

Li Zhuo-xin

Soil and Fertilizer Institute
Zhejiang Academy of Agricultural Sciences
Hanzhou, Zhejiang
China

Lin Chen-hang

Agricultural Research Institute
Sinyang, He Naon
China

Lin Shi-ru

Soil and Fertilizer Institute
Gauang Shi Academy of Agricultural Sciences
China

Lin Xinxiong

Nanjing Institute of Soil Science
Academia Sinica
Nanjing, China

Lin Yue-chan

Department of Biology
Zhongshan University
Guangzhou, China

Liu Chung-chu

Fujian Academy of Agricultural Sciences
Fuzhou, China

L. Loudhapasitiporn

Soil Science Division
Department of Agriculture
Ministry of Agriculture and Cooperatives
Bangkok, Thailand

Lu Pei-ji

Soil and Fertilizer Institute
Fujian Academy of Agricultural Sciences
Fuzhou, China

Lu Shuying

Wenzhou Municipal Scientific and
Technological Commission
Wenzhou, Zhejiang
China

T.A. Lumpkin

Department of Agronomy and Soils
Washington State University
Pullman, Washington, USA

B.B. Mabbayad

Department of Agronomy
University of the Philippines at Los Baños
College, Laguna, Philippines

Mo Hsi-mu

Department of Biology
South China Teachers Normal College
Guangzhou, China

O. Mochida

Entomology Department
International Rice Research Institute
P.O. Box 933
Manila, Philippines

B.W. Norton

University of Queensland
Sta. Lucia
Australia 4067

Ran Ye-huan

Tian Jian Ecological Eng. Institute
China

H.W. Scharpenseel

University of Hamburg
Ordinariat für Bodenkunde
Melle Park 10, 2000 Hamburg 13
West Germany

Shang Deng-hui

Xin Yang Agricultural Experimental Station
Jiangsu, China

W. H. Shaw

Darwin Institute of Technology
P.O. Box 40146
Casuarina NT 5792
Australia

N. Shiomi

Department of Applied Biology
Radiation Center of Osaka Prefecture
Sakai, Osaka, Japan

Shong Mo

Nuclear Utilization Institute
Academia Sinica
Beijing, China

W. H. Smith

International Rice Research Institute
P. O. Box 933
Manila, Philippines

P.J. Stangel

International Fertilizer Development Center
Muscle Shoals, Alabama, USA

Prayoon Swardee

Soil Science Division
Department of Agriculture
Bangkok, Thailand

C. Van Hove

Universite Catholique de Louvain
Place Croix du Sud, 4
B-1348 Louvain-la-Neuve
Belgium

Wang De-xian

Institute of Atomic Energy Utilization
Zhejiang Academy of Agricultural Sciences
China

Wang Fang-xiong

Soil Chemistry Department
Chin Yang Agricultural College
China

Wang Pu

Department of Agronomy
Beijing Agricultural University
Beijing, China

Wang Zai de

Department of Agronomy
Beijing Agricultural University
Beijing, China

I. Watanabe

Soil Microbiology Department
International Rice Research Institute
P.O. Box 933
Manila, Philippines

T.M. de Waha Baillonville

Universite Catholique de Louvain
Place Croix du Sud, 4
B-1348 Louvain-la-Neuve
Belgium

Wei Wen-xiong

Azolla Research Center
Fujian Academy of Agricultural Sciences
Fuzhou, China

Wei You-zhong

Department of Soil Science
Agricultural University of Zhejiang
Zhejiang, China

Wen Qi-xiao

Nanjing Institute of Soil Science
Academia Sinica
Nanjing, China

Wen Yag-huang

Department of Soil Fertilization
Jiangxi Academy of Agricultural Sciences
Nanchang, China

Xiao Qin-yuan

Soil and Fertilizer Institute
Hunan Academy of Agricultural Sciences
China

Xie Yin-xian

Soils and Fertilizer Institute
Chinese Academy of Agricultural Sciences
Beijing, China

Xu Qie-ming

Soil and Fertilizer Institute
Anhui Academy of Agricultural Sciences
Anhui, China

Yang Yu-ai

Department of Soil Science
Agricultural University of Zhejiang
Zhejiang, China

You Chongbiao

Institute for Application of Atomic Energy
Chinese Academy of Agricultural Sciences
Beijing, China

Zhang Chunlun

Soil and Fertilizer Institute
Sichuan Academy of Agricultural Sciences
Sichuan, China

Zhang Zhuang-ta

Soil and Fertilizer Institute
Guangdong Academy of Agricultural Sciences
Guangzhou, Guangdong
China

Zheng Wei-wen

Soil and Fertilizer Institute
Fujian Academy of Agricultural Sciences
Fuzhou, China

Zhu Zhonglin

Soil and Fertilizer Institute
Sichuan Academy of Agricultural Sciences
Sichuan, China